



# Installation Instructions

## Rear Bumper

Product Number: Y1351

Application: '05-Current Toyota Tacoma

## SAFETY

### Your safety and the safety of others is very important.

- In order to help you make informed decisions about safety, we have provided installation instructions and other information.
- These instructions alert you to potential hazards that could hurt you or others.
- Please do a job safety analysis (JSA) before each task to identify potential hazards for your situation and remove/protect against them.
- You must use your own good judgment, and take your time.

**Read and understand all safety precautions and instructions before installing this product.**

THIS PRODUCT IS FOR OFFROAD USE ONLY. ALL LIABILITY FOR INSTALLATION AND USE RESTS WITH THE OWNER.

**CARELESS INSTALLATION AND OPERATION CAN RESULT IN SERIOUS INJURY OR EQUIPMENT DAMAGE.**

## Injury hazard

### Failure to observe these instructions could lead to severe injury or death.

- Always** remove jewelry and wear eye protection.
- Always** use extreme caution when jacking up a vehicle for work. Set emergency brake and use tire blocks. Locate and use the vehicle manufacturers designated lifting points. Use jack stands.
- Always** use appropriate and adequate care in lifting components into place.
- Always** insure components will remain secure during installation and operation.
- Always** wear safety glasses when installing this kit. A drilling operation will cause flying metal chips. Flying chips can cause serious eye injury.
- Always** use extreme caution when drilling on a vehicle. Thoroughly inspect the area to be drilled (on both sides of material) prior to drilling, and relocate any objects that may be damaged.
- Always** use extreme caution when cutting and trimming during fitting.
- Always** tighten all nuts and bolts securely per installation instructions.
- Always** route electrical cables carefully. Avoid moving parts, components that become hot and rough or sharp edges.
- Always** insulate and protect all exposed wiring and electrical terminals.
- Always** perform regular inspections and maintenance on mounts and related hardware.



# Installation Instructions

## Rear Bumper

Product Number: Y1351

Application: '05-Current Toyota Tacoma

### I. Overview

Congratulations on your new purchase of the industries' best and most stylish rear bumper for the 2005 and newer Toyota Tacoma! This bumper has been **engineered** for strength.

Your bumper is designed in 3-D from digitized data, CNC laser cut, fabricated, and powder coated...all in the U.S.A.

Enjoy the fit and finish of a Toyota Tacoma rear bumper from Fab Fours Inc.

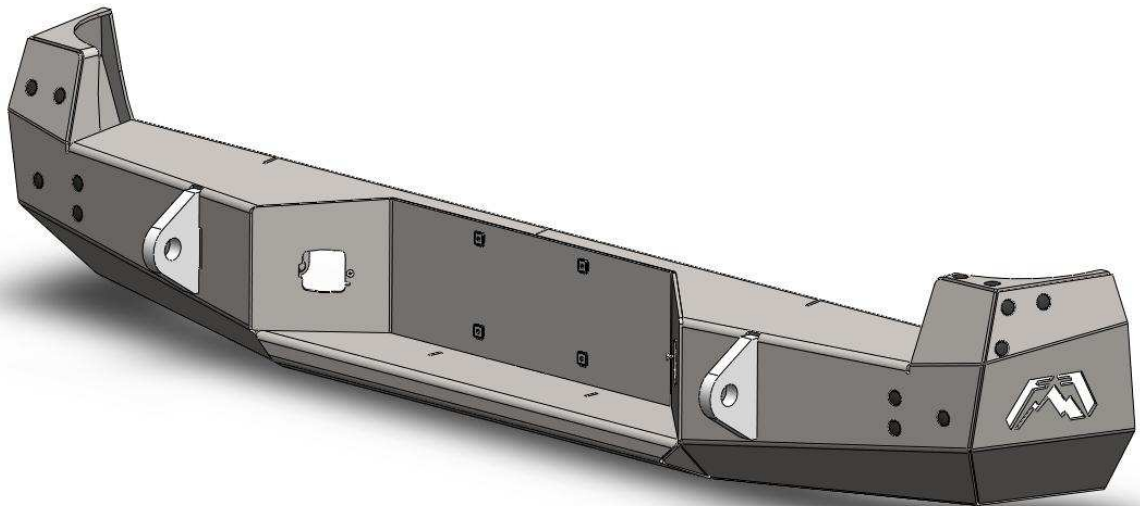



# Installation Instructions

## Rear Bumper



Product Number: Y1351

Application: '05-Current Toyota Tacoma

### II. Tools Required

- 19mm (3/4"), 17mm, 9mm (11/32") Wrench
- 19mm (3/4"), 17mm, 9mm (11/32") Socket
- Phillips Screw Driver
- Ratchet wrench
- 5/64" Allen key or hex drive

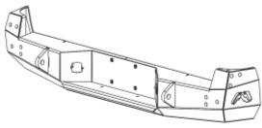
### III. Kit Contents

QTY	DESCRIPTION	FAB FOURS PART NUMBER
 x 1	Y1351 Bumper Shell	Y1351
 x 1	Y1351 Hardware Kit	61369
 x 1	Y1351 Instruction Manual	Y1351-IM



# Installation Instructions

## Rear Bumper

Product Number: Y1351

Application: '05-Current Toyota Tacoma

### IV. Included Hardware

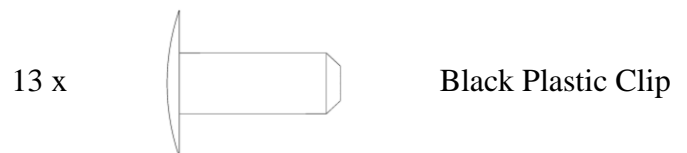
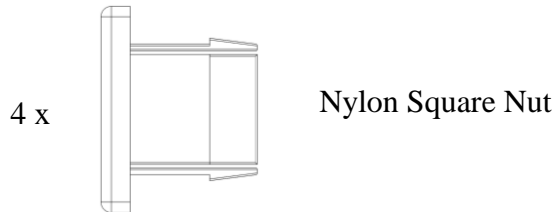
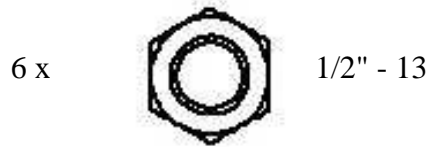
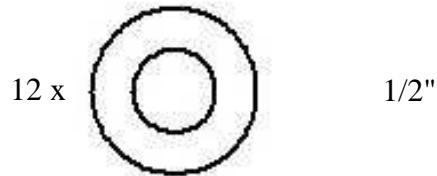
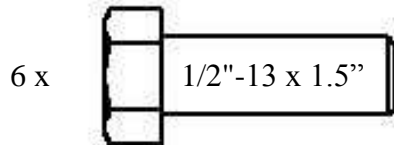



## Installation Instructions

### Rear Bumper

Product Number: Y1351

Application: '05-Current Toyota Tacoma

#### V. Removal of Factory Bumper

**A. Remove the license plate lights by removing the small Phillips screws and pulling the housings from the bumper. You will have to disconnect the harnesses from each.**



**Figure 1 – License plate light removal**

**B. Remove the plastic caps that cover the two bolts holding the OEM bumper to the trailer hitch bar. Squeezing the caps with your fingers should help to pop them free.**



**Figure 2 – Bolt cover removal**



## Installation Instructions

### Rear Bumper

Product Number: Y1351

Application: '05-Current Toyota Tacoma

**C. Using 19mm or 3/4" sockets and wrenches, remove the two vertical bolts holding the OEM bumper the trailer hitch bar. If this is the first time that the bumper has been removed, these may be difficult to break loose.**



**Figure 3 – Trailer hitch bolt removal**

**D. Using a 17mm socket or wrench, remove the bolts holding the OEM bumper to the frame rails of the vehicle (2 per side).**

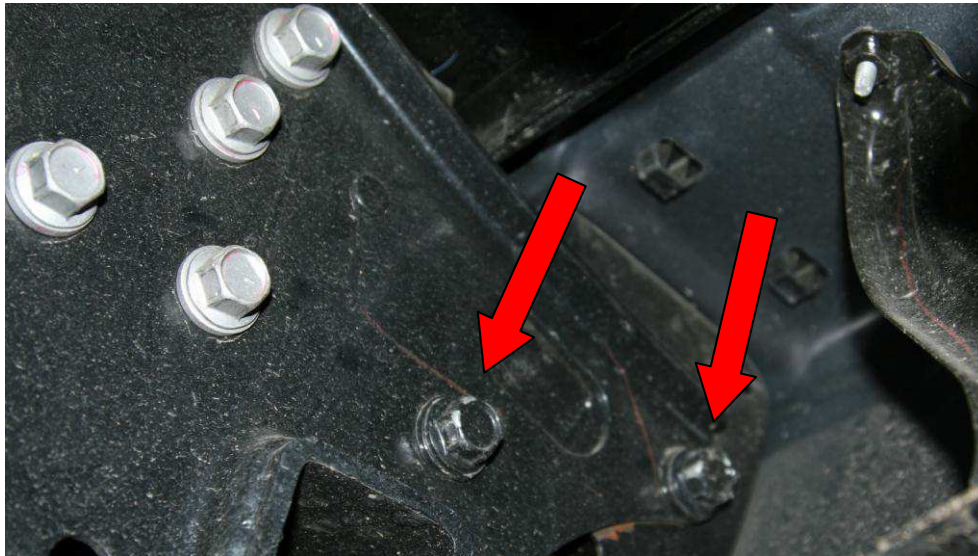

**Figure 4 – OEM bumper bolt removal**



## Installation Instructions

### Rear Bumper

Product Number: Y1351

Application: '05-Current Toyota Tacoma

***E. Remove the OEM bumper from the vehicle. The factory bumper may be wedged between the chassis mounts rather tight. It is recommended to have a helper to assist in the removal of the bumper to avoid injury and damage to the vehicle.***

## VI. Installation Instructions

***A. With the assistance of a friend (or two) slide your new Fab Fours bumper in between the OEM mounting locations. Some vehicles may require some tweaking of the OEM mounting plates to correct the width between them enough to allow the Fab Fours bumper to mount to the vehicle. (Approximately 37")***

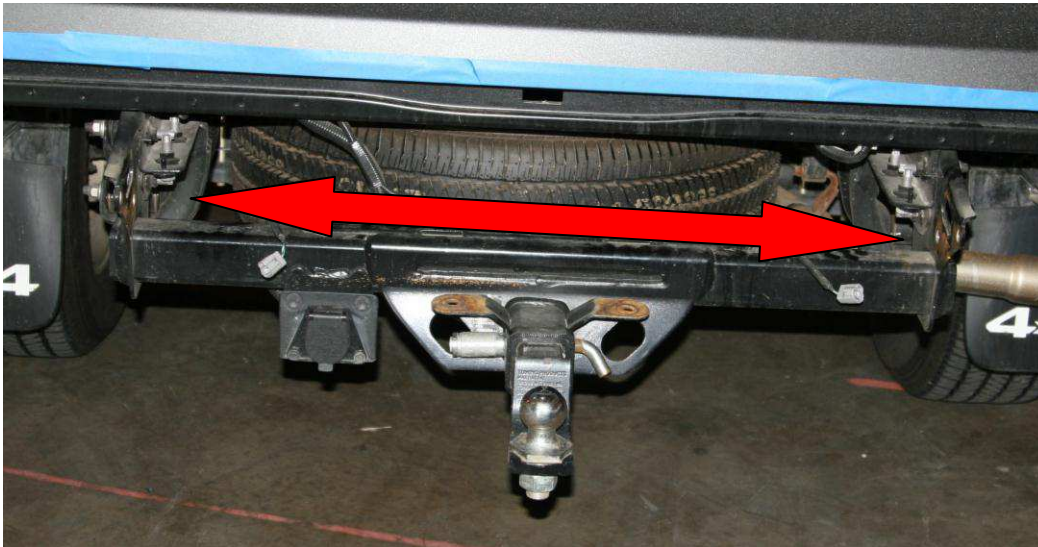

***Figure 5 – OEM mounting plates may need width adjustment***



## Installation Instructions

### Rear Bumper

Product Number: Y1351

Application: '05-Current Toyota Tacoma

***B. Fasten the Fab Fours bumper to the vehicle using the supplied 1/2" hardware. Do not fully tighten hardware until you are satisfied with the positioning of the bumper.***

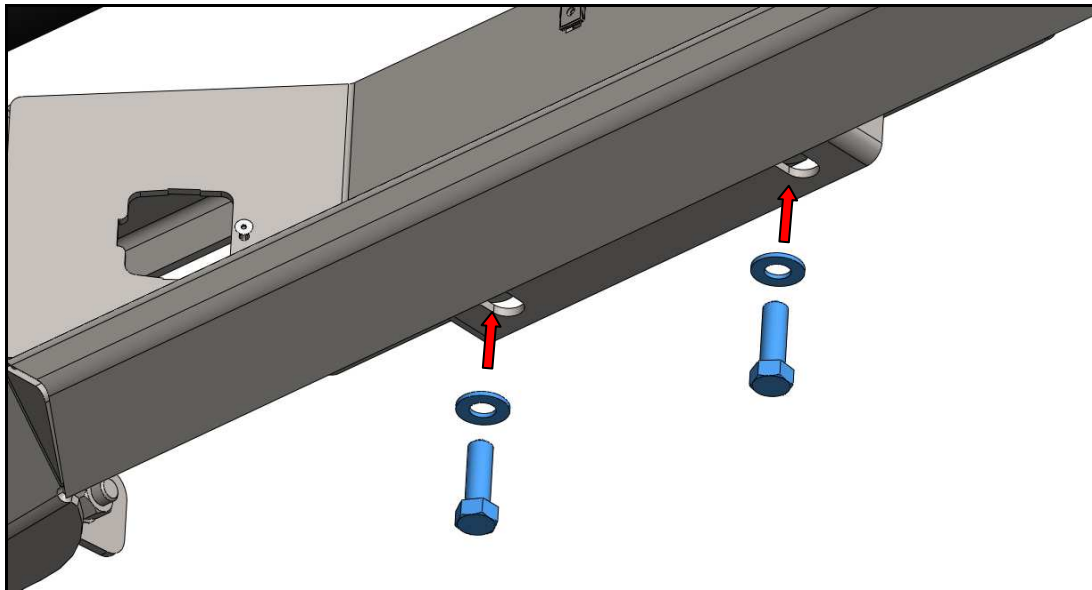
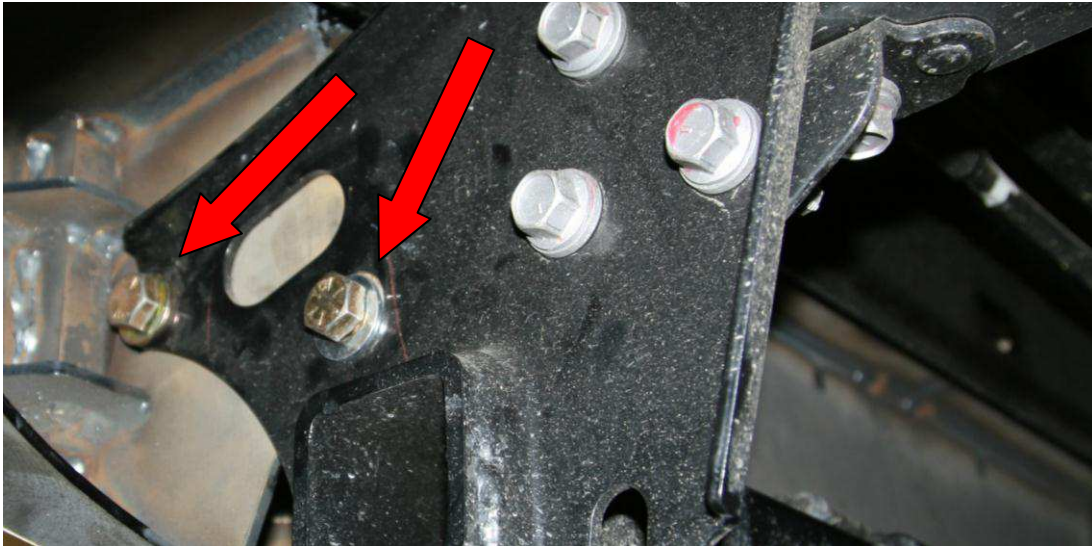

***Figure 6 – Fitting supplied hardware to mounted Fab Fours bumper***





## Installation Instructions

### Rear Bumper

Product Number: Y1351

Application: '05-Current Toyota Tacoma

**C. Insert the four supplied square, nylon license plate nuts into the cutouts in the center of the Fab Fours bumper.**

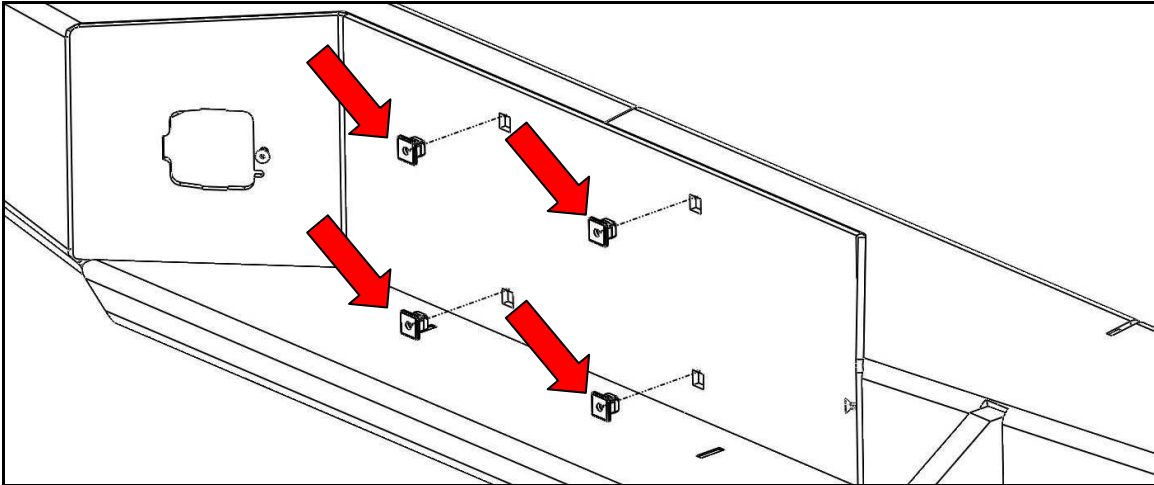

**Figure 7 – License plate nylon nut insertion**

**D. Install the license plate illumination lights into the cutouts in the Fab Fours bumper using the provided 8-32's hardware. Don't forget to plug the light harnesses into the back of the light housings before installation!**

**E. Insert the 13 provided black plastic Christmas tree clips into the unused holes in the bumper shell.**



## Installation Instructions

### Rear Bumper

Product Number: Y1351

Application: '05-Current Toyota Tacoma

## VII. Maintenance/Care

- Periodically check and tighten all fasteners
- Stripped, fractured, or bent bolts or nuts need to be replaced
- After washing of the vehicle make sure to fully dry all surfaces

## VIII. Contact Information

Fab Fours Inc.  
1312 Camp Creek Rd.  
Lancaster, SC 29720

Phone (866)-385-1905  
Fax (866)-574-1424  
Email [Support@fabfours.com](mailto:Support@fabfours.com)

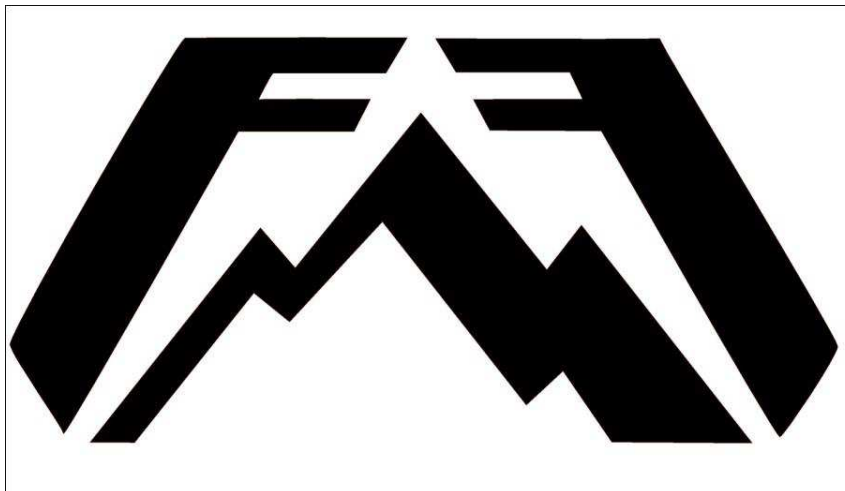

More than expected... Better than expected