



IMPORTANT WARRANTY & INSTALLATION
INSTRUCTIONS ATTACHED

*Please Forward All Attached Information to Consumer
Warranty Not Valid Unless Returned to CORSA Exhaust*

We ask that you take a few moments to complete our warranty registration form:

TO ACTIVATE YOUR LIMITED LIFETIME WARRANTY GO TO:
CORSAPERFORMANCE.COM/WARRANTY



**For Full-Color Installation Instructions, Please Visit:
CORSAPERFORMANCE.COM and Search by Part Number**

Please be sure to review the enclosed instructions prior to beginning the installation process. If you have any questions about the enclosed parts, instructions or encounter a problem during installation:
CALL CORSA PERFORMANCE TECHNICAL ASSISTANCE AT 800.486.0999

Please take time to read and understand these installation instructions.

CORSA recommends that the installation of this system be performed by a qualified service center or professional muffler installer who has the necessary equipment, tools and experienced personnel. However, if you decide to perform this install, the use of a hoist and an additional person will be required.

NOTE: The installation of this CORSA Performance Exhaust system requires cutting and clamping onto the stock active valves. The presence of the active valves is needed to achieve the acoustic target of the system.

CAUTION: Never work on a hot exhaust system. Allow time for the vehicle to cool. Always wear eye protection when working under a vehicle.

Recommended Tools:

- 3/8" drive ratchet
- 3/8" drive long extension
- 3/8" drive swivel adapter
- 3/8" drive 13mm short socket
- 3/8" drive 15mm deep socket
- Grommet pullers
- Soap and water solution
- Torque Wrench
- Chain cutters
- File or deburring tool
- Safety glasses

Please confirm that all parts are present before beginning the factory exhaust system removal and CORSA exhaust system installation.

Challenger
Valve-Back
 21020(BLK)
 21021

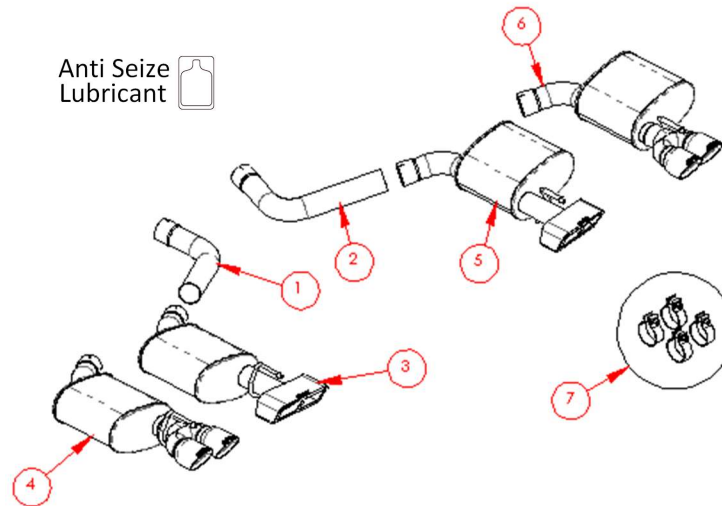

21020(BLK) Bill of Materials

1. 18LC4019 – AXLE PIPE ASSEMBLY DRV
2. 18LC4020 – AXLE PIPE ASSEMBLY PASS
4. 18LC2041 – REAR MUFFLER ASSEMBLY DRV (ROUND TIPS)
6. 18LC2042 – REAR MUFFLER ASSEMBLY PASS (ROUND TIPS)
7. 16CM7005 – HARDWARE KIT

21021 Bill of Materials

1. 18LC4019 – AXLE PIPE ASSEMBLY DRV
2. 18LC4020 – AXLE PIPE ASSEMBLY PASS
3. 18LC2023 – REAR MUFFLER ASSEMBLY DRV (GTX2 TIPS)
5. 18LC2024 – REAR MUFFLER ASSEMBLY PASS (GTX2 TIPS)
7. 16CM7005 – HARDWARE KIT

Charger/300

Valve-Back

21019(BLK)

21022

Anti Seize
Lubricant 

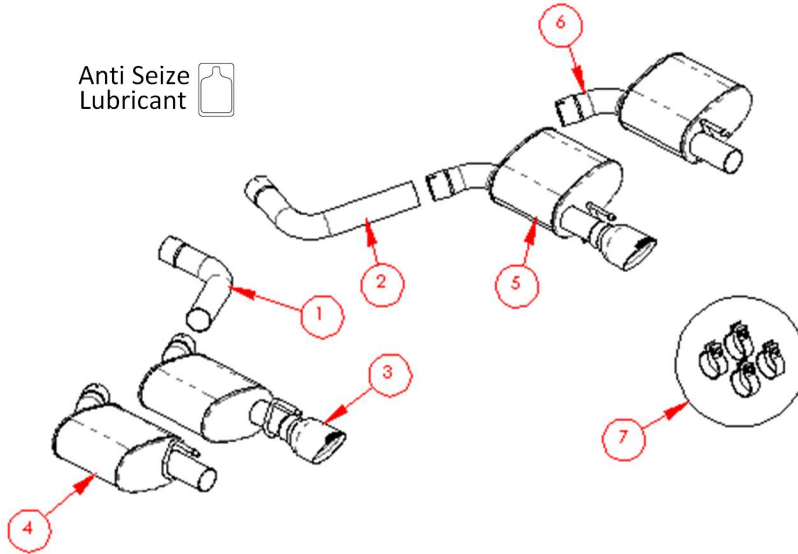

21019(BLK) Bill of Materials

1. 18LC4019 – AXLE PIPE ASSEMBLY DRV
2. 18LC4020 – AXLE PIPE ASSEMBLY PASS
3. 18LC2031 – REAR MUFFLER ASSEMBLY DRV
5. 18LC2032 – REAR MUFFLER ASSEMBLY PASS
7. 16CM7005 – HARDWARE KIT

21022 Bill of Materials

1. 18LC4019 – AXLE PIPE ASSEMBLY DRV
2. 18LC4020 – AXLE PIPE ASSEMBLY PASS
4. 18LC2049 – REAR MUFFLER ASSEMBLY DRV
6. 18LC2050 – REAR MUFFLER ASSEMBLY PASS
7. 16CM7005 – HARDWARE KIT

Factory Exhaust System Removal:

1. **Charger model ONLY** – Challenger model skip to step 2. If your vehicle has dumps (no tips), skip to step 5. Using a 3/8" driver ratchet and a 13mm deep socket, remove the eight nuts holding up the front and rear chassis stiffening plates and remove the front and rear plates from the vehicle. **(Fig. A)**
2. Locate the driver and passenger side active valve modules located near the tunnel muffler exhaust hangers just in front of the rear differential. Disconnect both modules by pushing the tab on the top of the connector plugs and sliding the connector plugs upwards. **(Fig. B)**

NOTE: Do not start the vehicle or turn on the accessory power once the valves are unplugged, as this will trigger a check engine light.

3. Using grommet pullers or a similar device, remove the driver and passenger side tunnel muffler hangers from their corresponding hanger grommets. **(Fig. C)**

NOTE: The use of a soap and water solution may aid in the removal of hanger grommets.

4. Using a 3/8" drive ratchet and 15mm deep socket, loosen the driver and passenger side clamps at the cat-back connection point. **(Fig. D)**
5. Using a 3/8" ratchet, 13mm short socket, swivel adapter, and long extension, unbolt both the driver and passenger side front and rear hanger grommet assemblies from the vehicle chassis. Use jack stands or a similar device to support the front and rear of the exhaust while unbolting the grommet assemblies. The exhaust is heavy and will no longer be supported once the grommet assemblies are unbolted. **(Fig. E & F)**

NOTE: If your exhaust dumps into a "tip" built into the valence, there is a slight change in the process after step 5. In order to give you the ability to take the stock exhaust system down, you need to do Step 2 from the install section on pg. 7 while the stock system is still on the car. You must cut the valve section area apart while the system is still on the car in order to allow the stock system the mobility to slide it forward out of the cup that the pipe dumps into. You will not need to remove the mid-section.

6. The stock exhaust can now be removed by sliding the system rearward to clear the overlapping pipe connection at the cat-back connection point; then lower the remaining portion of the stock exhaust system. **(Fig. G)**

NOTE: Depending on your vehicle year, your stock system may not have front rear muffler hangers.

7. Using grommet pullers or a similar device, remove the front and rear hanger grommet assemblies from the rear driver and passenger side mufflers. **(Fig. H & I)** Make note of the hanger grommet assemblies' orientation as they will be installed in the same position on the CORSA Performance exhaust system. Remove the ground wire from the rear passenger exhaust hanger. **(Fig. J)** This concludes the stock exhaust removal process.

NOTE: The use of a soap and water solution may aid in the removal of hanger grommets.

REMOVAL PICTURES ON NEXT PAGE 



Fig. A



Fig. B



Fig. C



Fig. D



Fig. E



Fig. F



Fig. G

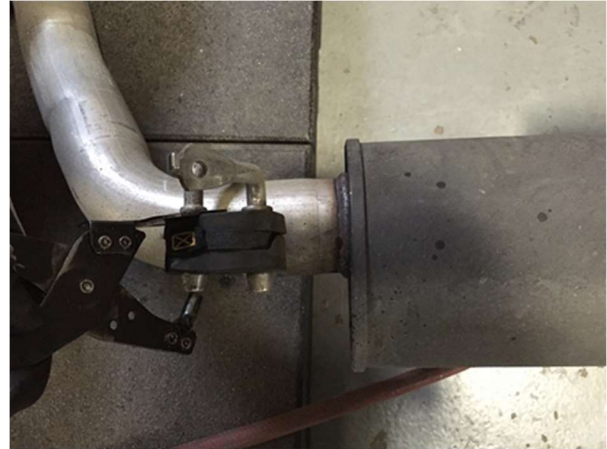

Fig. H



Fig. I

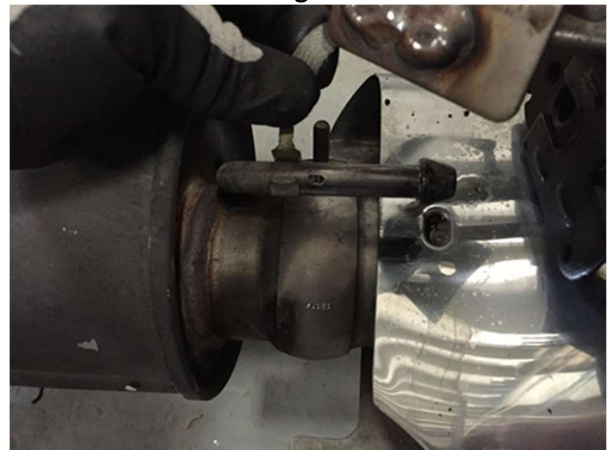
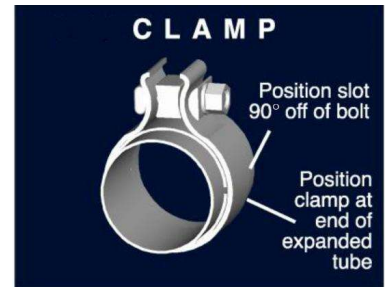

Fig. J

Installation of CORSA Exhaust System:

NOTE: Apply the anti-seize lubricant (supplied) to the threads **ONLY** of all the clamps and flange bolts. Failure to follow this procedure can cause nuts to seize on clamps and potentially destroy threads. After applying anti-seize lubricant, be sure to thoroughly clean your hands, as lubricant will tarnish stainless steel. All clamps should be tightened using a properly calibrated Torque Wrench. Using an air impact gun will damage the clamp and reduce its ability to effectively seal the joint. It may also cause the joint to separate, thereby causing damage to your exhaust system and to your vehicle.

NOTE: Align all clamps so that the center of the clamp bolt is 90 degrees from the notch in the pipe. (See Fig. CLAMP)



1. Remove all exhaust system components from the shipping boxes, including clamps and hardware.
8. Starting at the rear of the driver side valve, measure and mark 4" from the raised valve assembly. **(Fig. K)** On the rear of the passenger side valve, measure and mark 3 ¾" from the raised valve assembly. **(Fig. L)** Using chain cutters or a similar device cut the driver and passenger side exhaust pipes at the marked locations perpendicular to the pipes. **(Fig. M)** The rear mufflers will now be separated from the front exhaust section. **(Fig. N)** Deburr the cut edge using a file or deburring tool. If your vehicle has dumps (no tips), skip to step 4.
2. Re-install stock crossover pipe with valves still attached. Slide each hanger into the grommets that it came out of in Factory Exhaust Removal Step 3.
3. Reconnect the crossover pipe at the cat-back connection point. Then using a 3/8" drive ratchet and 15mm deep socket, tighten the driver and passenger side clamps at that point. **(Fig. O)**
4. Locate the passenger side axle pipe along with a 2.75" clamp. Install the clamp on the expanded end of the axle pipe. Position the clamp so that the bolt is vertical with the nut towards the ground and the bolt towards the outside of the vehicle. Slide the expanded end of the axle pipe over the passenger side valve assembly. **(Fig. P)** Using a 15mm deep socket and ratchet, snug the clamp.
5. Repeat step #5 for the driver side of the vehicle.
6. Locate the passenger side rear muffler, a 2.75" clamp, the corresponding passenger hanger grommet assemblies removed from the stock exhaust removal process, and the two 13mm bolts for the hanger grommet assemblies. If present, install the front hanger grommet onto the front muffler hanger in the same position as removed from

INSTALLATION INSTRUCTIONS CONTINUED ON NEXT PAGE



the stock system. **(Fig. Q)** Next, install the rear hanger grommet onto the rear muffler hanger, again, in the same position as removed from the stock exhaust. **(Fig. R)** Then, install the clamp on the expanded end of the rear muffler inlet pipe. Position the clamp so that the bolt is vertical with the nut towards the ground and the bolt towards the front of the vehicle. Slide the expanded end of the muffler inlet pipe over the passenger side axle pipe. Using a 13mm short socket, swivel adapter, 3/8" drive extension, and ratchet install the front and rear hanger grommet assemblies reusing the stock bolts. **(Fig. S & T)**. On the passenger side only, clip the ground wire from the hanger grommet assembly onto the rear muffler hanger. **(Fig. U)** Using a 15mm deep socket and ratchet, snug the clamp on the muffler inlet as shown. **(Fig. V)**

7. Repeat step #6 for the driver side of the vehicle.
8. Connect both the passenger and driver side active valve modules. **(Fig. W)**
9. **Charger model ONLY**
Locate the two chassis brackets and the hardware removed from step #1 of the stock exhaust removal process. Re-install the plates using a 3/8" drive ratchet and 13mm socket **(Fig. X)** Torque to factory recommended value.
10. Check that the clearance to the suspension mounts are adequate on both sides. Make sure that the x-pipe is level and not rotated to one side, this will ease tip adjustment. Check clearance between the driver side axle pipe and the spare tire well.
11. Adjust the system accordingly, including the rear muffler depth and rotation, so that the exhaust tip outlets are centered in the bumper exhaust cutouts. **(Fig. Y or Z)** Check clearance between the system components and chassis. Confirm the passenger side axle pipe does not interfere with the heat insulated wires protruding from the spare tire well. At this time, tighten all clamps to 45ft-lbs using the torque wrench and 15mm socket. This concludes the CORSA Performance exhaust installation.

NOTE: Slightly loosening the rear muffler hanger assemblies from the vehicle chassis will allow side to side adjustment of the tips. Hold the tip centered in the valance cut out while a helper tightens the hanger grommet assemblies.

NOTE: During cold weather start-ups, you may experience an exhaust sound that is deeper and louder in tone than usual. This is temporary and will diminish to normal levels once your engine has reached its normal operating temperature.

NOTE: Immediately following the installation of your exhaust system, you may experience a trace of smoke after initial start-up. DO NOT be alarmed. The smoke is caused by the burning of a small amount of forming oil residue used in the manufacturing process.

INSTALLATION PICTURES ON NEXT PAGE



CORSA Installation Pictures



Fig. K



Fig. L



Fig. M



Fig. N



Fig. O



Fig. P



Fig. Q

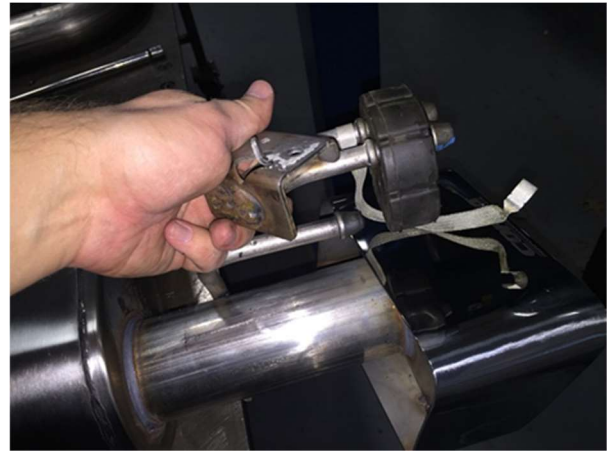

Fig. R



Fig. S



Fig. T



Fig. U



Fig. V

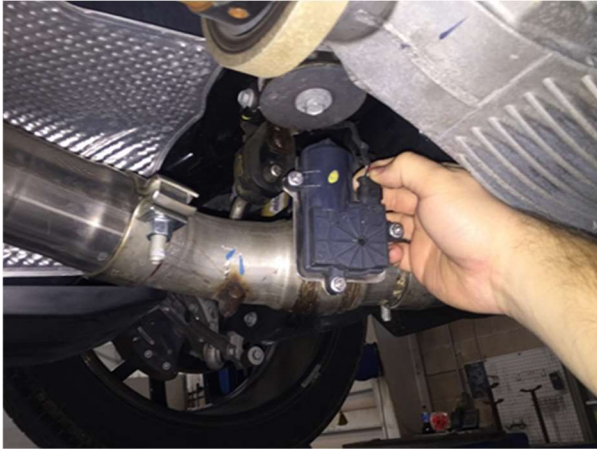

Fig. W



Fig. X



Fig. Y



Fig. Z