

Installation for Ford Explorer PN's- 140656, 140659, 140658



These instructions have been written to help you with the installation of your Borla Performance Exhaust System. Please read this document completely before beginning the installation of your system.

Please compare the parts in the box with the bill of materials provided to assure that you have all the parts necessary for this installation.

To ensure this part number fits your specific model year, please visit our website for the latest model year listings at www.BORLA.com.

Thank you for purchasing a Borla Performance Cat-Back™ Exhaust System.

Borla Performance Cat-Back™ Exhaust Systems (PN-140656, 140659) are designed for the Ford Explorer, 3.5L EcoBoost Engine, 4-WD/FWD automatic transmission.

Borla Performance Cat-Back™ Exhaust System (PN-140658) is designed for the Ford Explorer, 3.5L Engine, 4-WD/FWD automatic transmission.

Borla Performance Industries recommends that an exhaust shop or professional after market parts installer perform the installation of this system. However, if you decide to perform the installation on your own it is recommended that two people are used. This installation should not be performed by one person due to the risk of injury. Ensure the installers use all under car safety precautions including eye protection.

Please take time to read and understand the following...

By installing your Borla Performance Exhaust System, you indicate that you have read this document and you agree with the terms stated below.

It is the responsibility of the purchaser to follow all installation instruction guidelines and safety procedures supplied with your Borla Performance Exhaust System.

Borla Performance Industries assumes no responsibility for damages occurring from misuse, abuse, improper installation, improper operation, lack of responsible care, or all previously stated reasons resulting from incompatibility with other manufacturer's products and/or systems.

Included with your Borla Performance Exhaust System is a warranty card. Please read it carefully before you begin any work on your vehicle. If you should have any questions regarding our warranty policy, installation, or any other matter pertaining to your new Borla Performance Exhaust System, please give us a call at the number provided on the warranty card.

Minimum Required Tool List:

TOOLS:

- 1 3/8" Drive Ratchet
- 2 3/8" Drive Extension 3"
- 3 metal-cutting saw
- 4 15mm Socket
- 5 Pry Bar

SHOP SUPPLIES:

- 1 Spray Lubricant

Borla Performance Cat-Back™ Bill of Materials

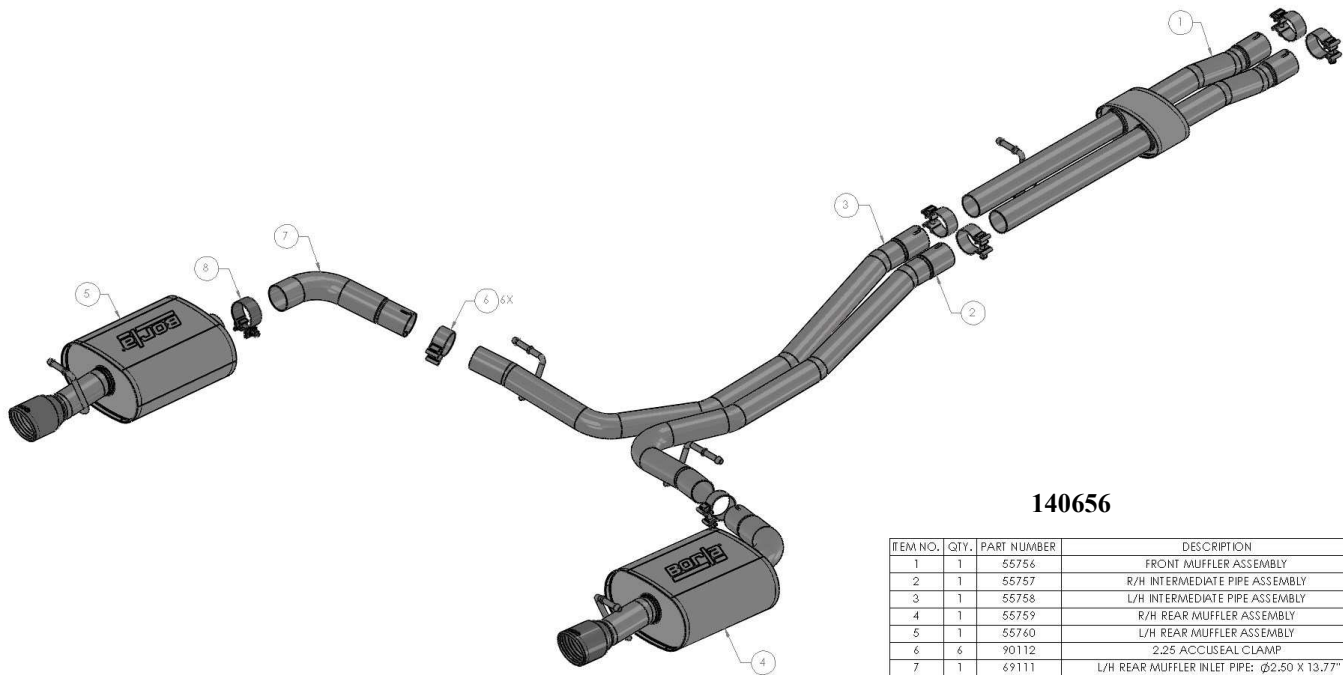

140656

ITEM NO.	QTY.	PART NUMBER	DESCRIPTION
1	1	55756	FRONT MUFFLER ASSEMBLY
2	1	55757	R/H INTERMEDIATE PIPE ASSEMBLY
3	1	55758	L/H INTERMEDIATE PIPE ASSEMBLY
4	1	55759	R/H REAR MUFFLER ASSEMBLY
5	1	55760	L/H REAR MUFFLER ASSEMBLY
6	6	90112	2.25" ACCUSEAL CLAMP
7	1	69111	L/H REAR MUFFLER INLET PIPE: Ø2.50 X 13.77"
8	1	90113	S/S ACCUSEAL CLAMP Ø2.50

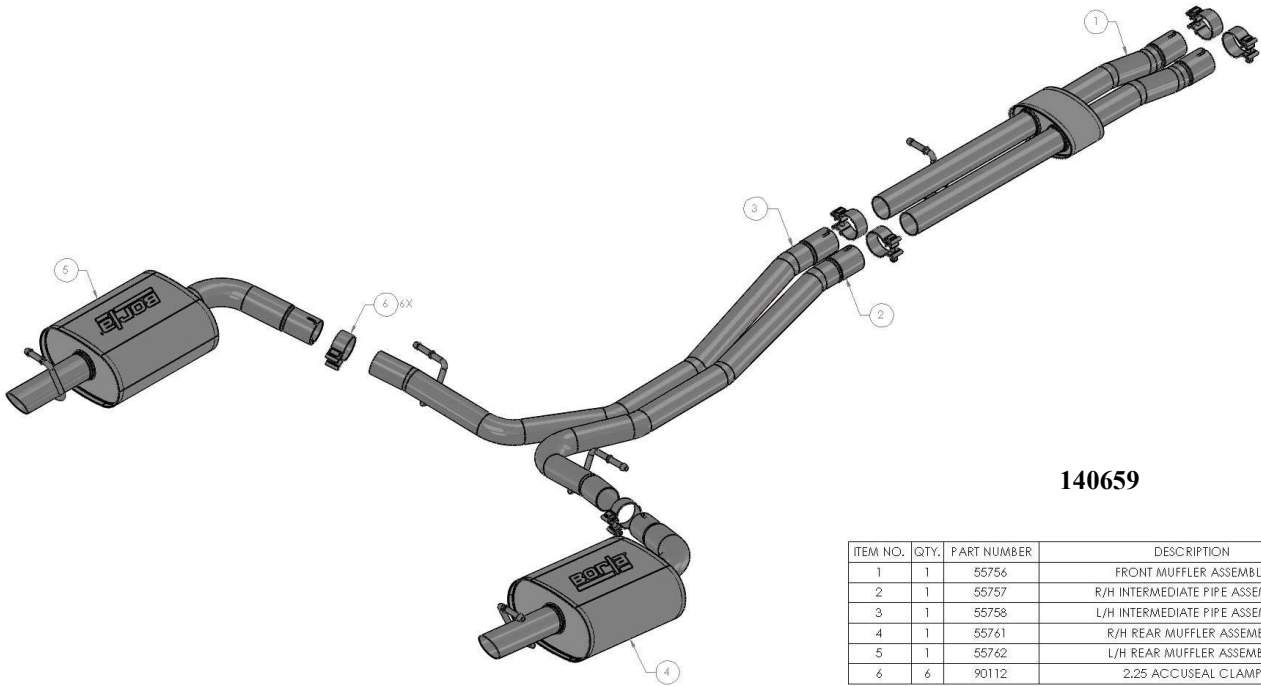

140659

ITEM NO.	QTY.	PART NUMBER	DESCRIPTION
1	1	55756	FRONT MUFFLER ASSEMBLY
2	1	55757	R/H INTERMEDIATE PIPE ASSEMBLY
3	1	55758	L/H INTERMEDIATE PIPE ASSEMBLY
4	1	55761	R/H REAR MUFFLER ASSEMBLY
5	1	55762	L/H REAR MUFFLER ASSEMBLY
6	6	90112	2.25 ACCUSEAL CLAMP

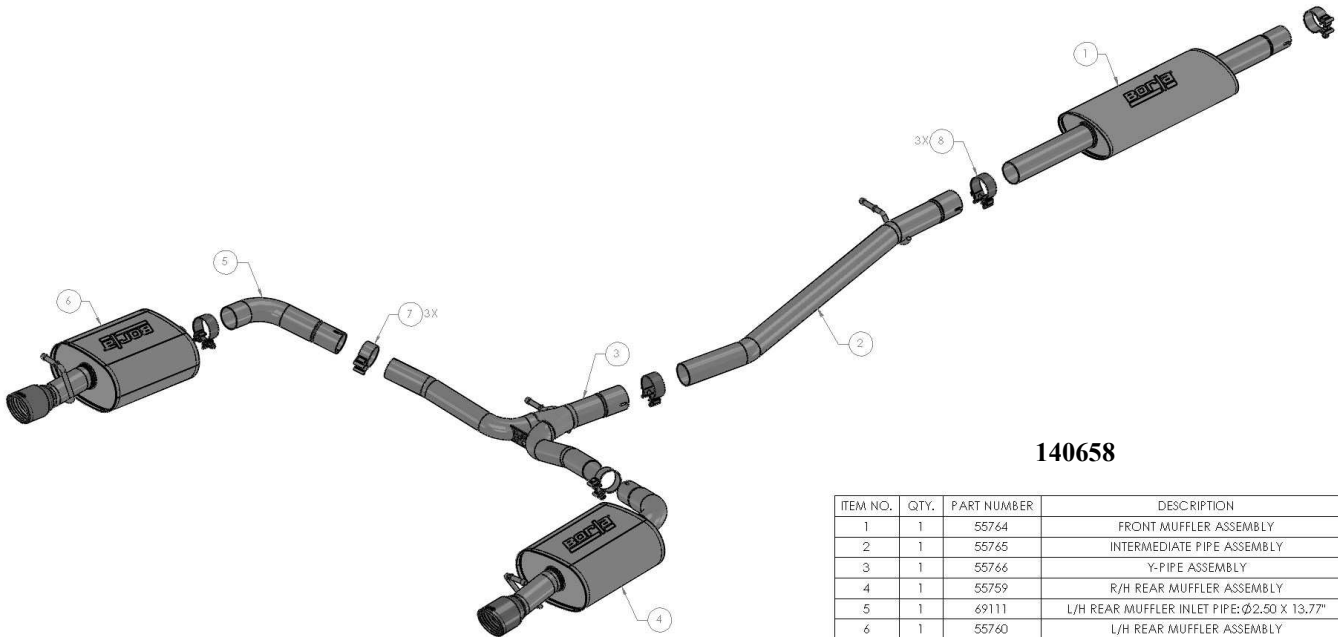

140658

ITEM NO.	QTY.	PART NUMBER	DESCRIPTION
1	1	55764	FRONT MUFFLER ASSEMBLY
2	1	55765	INTERMEDIATE PIPE ASSEMBLY
3	1	55766	Y-PIPE ASSEMBLY
4	1	55769	R/H REAR MUFFLER ASSEMBLY
5	1	69111	L/H REAR MUFFLER INLET PIPE: Ø2.50 X 13.77"
6	1	55760	L/H REAR MUFFLER ASSEMBLY
7	3	90112	2.25 ACCUSEAL CLAMP
8	3	90113	S/S ACCUSEAL CLAMP Ø2.50

Caution!!! *Never work on a hot exhaust system. Serious injury in the form of burns can result* If the vehicle has been in use and the exhaust system is hot, allow vehicle to cool for at least 1 hour. Always wear eye protection when working under any vehicle.

Note: It is our recommendation that you use a hoist or hydraulic lift to facilitate the installation of your new Borla Performance Exhaust System.

Taking all under car safety precautions, lift the vehicle using a hoist or hydraulic lift. Once this has been done, you may begin the removal of your old exhaust system from your vehicle.

Note: Before removing the original exhaust system from your vehicle, please compare the parts you have received with the bill of materials provided on the previous page to assure that you have all the parts necessary for the installation of your new Borla Performance Exhaust System.

Original Exhaust System Removal

Note: With a used vehicle, we suggest a penetrating spray lubricant to be applied liberally to all exhaust fasteners and allowing a significant period of time for the chemical to lubricate the threads before attempting to disassemble.

- A. **140656 & 140659 ONLY:** Factory exhaust tubing needs to be cut for removal. Using a metal-cutting equipped blade, carefully cut the factory inlet tubing on front muffler making sure not to damage vehicle. (See Fig. 1)
- B. **140658 ONLY:** Loosen hardware on clamp in front of Front Muffler factory exhaust.
 1. Lubricate rubber isolators, bolts and nuts.
 2. Using a muffler stand or an additional person to support factory exhaust, slide the hangers from rubber isolators on right-side and left-side on the rear mufflers. (See Figs. 2 & 3)
 3. Carefully remove the muffler section from the vehicle. (See Fig. 4)

Warning: Use extreme caution during installation. Torque all fasteners according to manufacturer's torque values and tightening sequence. **DO NOT** use air impact tools to tighten fasteners on Borla Performance Exhaust Systems. Use of such tools may result in bent flanges or gasket contact areas leading to exhaust leaks.

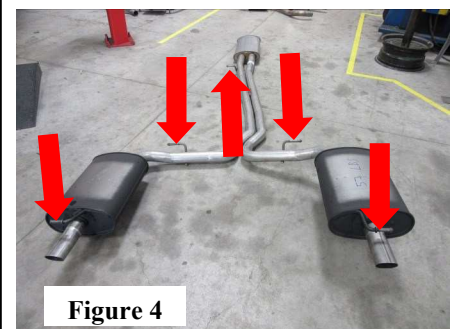
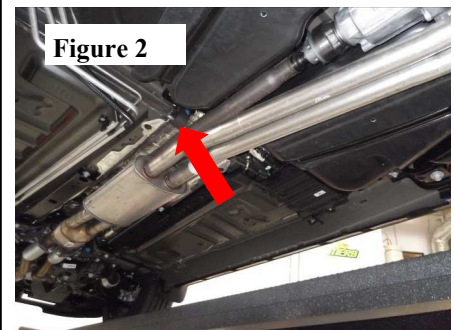
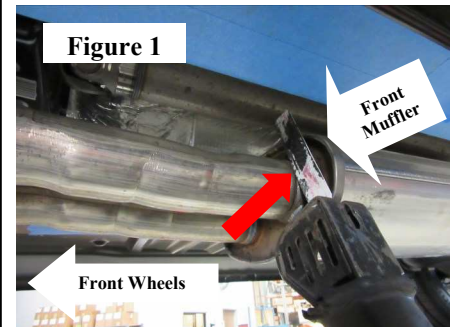

Borla Performance Exhaust System Installation

1. Insert a clamp over each expanded end of the **Front Muffler Assembly**, and insert the hanger into rubber isolator. (See Fig. 5)
2. Place a clamp over the expanded end of **R/H Intermediate Pipe Assembly** and insert inlet into right-side **Front Muffler Assembly**. Insert hangers into rubber isolator. **DO NOT TIGHTEN CLAMPS**. (See Fig. 6)
3. Place a clamp over the expanded end of **R/H Rear Muffler Assembly** and insert inlet into **R/H Intermediate Pipe Assembly**. Insert hanger into rubber isolator. **DO NOT TIGHTEN CLAMPS**. (See Fig. 7 with Round Tip option)
4. Repeat steps 2-3 for the **L/H Intermediate Pipe Assembly** and **L/H Rear Muffler Assembly**.
5. Check your exhaust system for proper clearance under the vehicle and also for tip alignment. (See Fig. 8 with Round Tip option)
6. Once position has been determined to be correct, tighten the Ac-cuseal clamps to 32-35 ft. lbs. **IMPORTANT: Make sure the clamp bolt is positioned between the pipe notches NOT over the pipe notches.**
7. Before starting your vehicle, make sure to check all wires, hoses, brake lines, body parts and tires for safe clearance from the exhaust system.
8. Start vehicle and check for any leaks. If any leaks are found, determine cause (such as loose or incorrectly positioned clamp) and repair as necessary.

Note: When you first start your vehicle after the installation of your new Borla Performance Exhaust System, there may be some smoke and fumes coming from the system. This is a protective oil based coating used in the manufacturing of mandrel bent performance exhaust tubing. This is not a problem and will disappear within a very short period of time after the exhaust has reached normal operating temperatures.

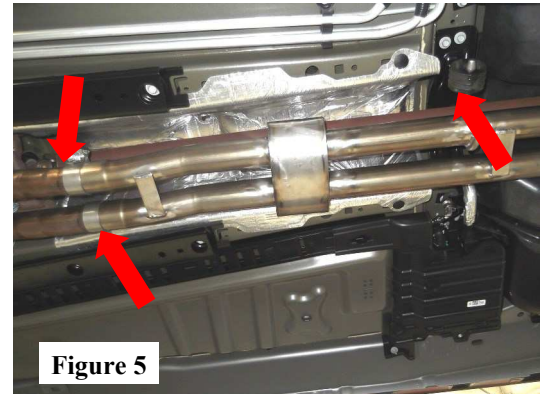
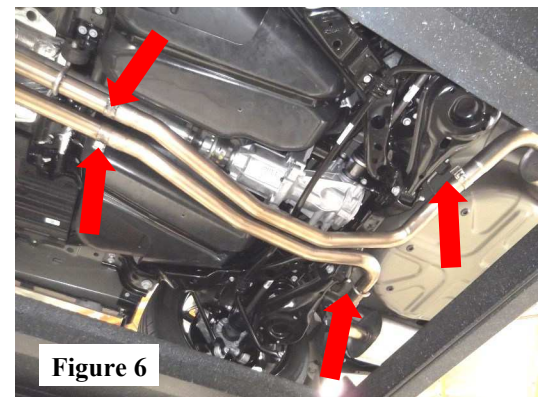
**Figure 5****Figure 6****Figure 7****Figure 8**