



BX2253

2009-12 Honda Fit

(Includes Foglights)

Installation Instructions

Please read **BOTH** these Installation Instructions and the General Instructions before attempting to install or operate this equipment.

Serial Number

- Blue Ox® towing products and accessories are intended to be installed by Blue Ox® Dealers who are familiar with our products and have the equipment necessary and knowledge to do “fit work”. When necessary Blue Ox® Dealers can be found at www.blueox.com or by contacting our Customer Care Department at (402) 385-3051.
- Many Blue Ox® baseplates are designed to use existing holes and hardware to mount the baseplate to the towed vehicle. Even though bolts are there, do not assume they are adequate for baseplate mounting. Always use hardware supplied in the hardware kit and existing hardware specified in the Baseplate Installation Instructions.

Attachment Tab Height: 13-1/2”
Attachment Tab Width: 24”

Bolt Torque Specifications

Torque in Foot-Pounds for Metric Bolts

Bolt Size	Grade 8.8	Grade 10.9
6MM	6	8
8MM	16	22
10MM	31	40
12MM	54	70
14MM	89	117

Confirm the towability and pre-towing procedures for your vehicle with the owner’s manual or contact the vehicle’s manufacturer for specific towing procedures.

Bolt Torque Specifications

Torque in Foot-Pounds for Inch Bolts

Bolt Size	Grade 5	Grade 8
1/4”	10	14
5/16”	19	29
3/8”	33	47
7/16”	54	78
1/2”	78	119
5/8”	154	230



If the front of your vehicle looks different than this, call us at (402) 385-3051.

WARNING

Failure to read and follow these instructions could result in separation of the towed vehicle from the tow bar, causing property damage, loss of towed vehicle, personal injury or death.

BX2253
2009-12 Honda Fit
(Includes Foglights)
Installation Instructions

Parts List

Ref. No.	Qty.	Part #	Description
1	1	61-6723	Weldment, BP, BX2253
2	2	102-6946	Spacer, BX2248
3	4	201-0368	3/8"-16 x 1-1/4" Hex Head Bolt, Grd. 5
4	2	201-0440	3/8"-16 x 1-1/2" Hex Bolt, Grd. 5, ZP
5	6	202-0090	3/8"-16 Hex Nyl. Ins. Lock Nut, ZP
6	2	201-0553	1/4"-20 x 1/2" Hx. Wshd, Type F Screw, ZP
7	2	201-0192	#10-32 x 1/2" Slot, Rd. Hd. Screw, ZP
8	2	203-0054	#10 Lock Washer, ZP
9	2	202-0047	#10-32 Hex Nut, ZP
10	2	101-5822	Adapter, 4 Way Connector
11	2	62-3469	Attachment, Assembly, SF/LB, 1 Hole
12	1	102-7134	Breakaway Bracket, BX2255
13	2	201-0050	1/4"-20 x 3/4" Hex Bolt Grd.5, ZP
14	2	202-0102	1/4"-20 Hex Nyl Nut, ZP
	2	226-0046	Baseplate Safety Cable, 36" Class III (Not Shown)
	2	229-0359	3/8" Quick Link, ZP (Not Shown)
	2	290-0437	Cap Plug, Black (Not Shown)

Tools Required

10MM Socket
 3/8" Nut Driver
 Phillips Screwdriver
 Tape Measure
 1" Hole Saw

12MM Socket
 Large Vice Grips
 Torque Wrench
 Drill
 Loctite® RED

9/16" Socket / Wrench
 Flat Screwdriver
 Utility Knife
 13/32" Drill Bit

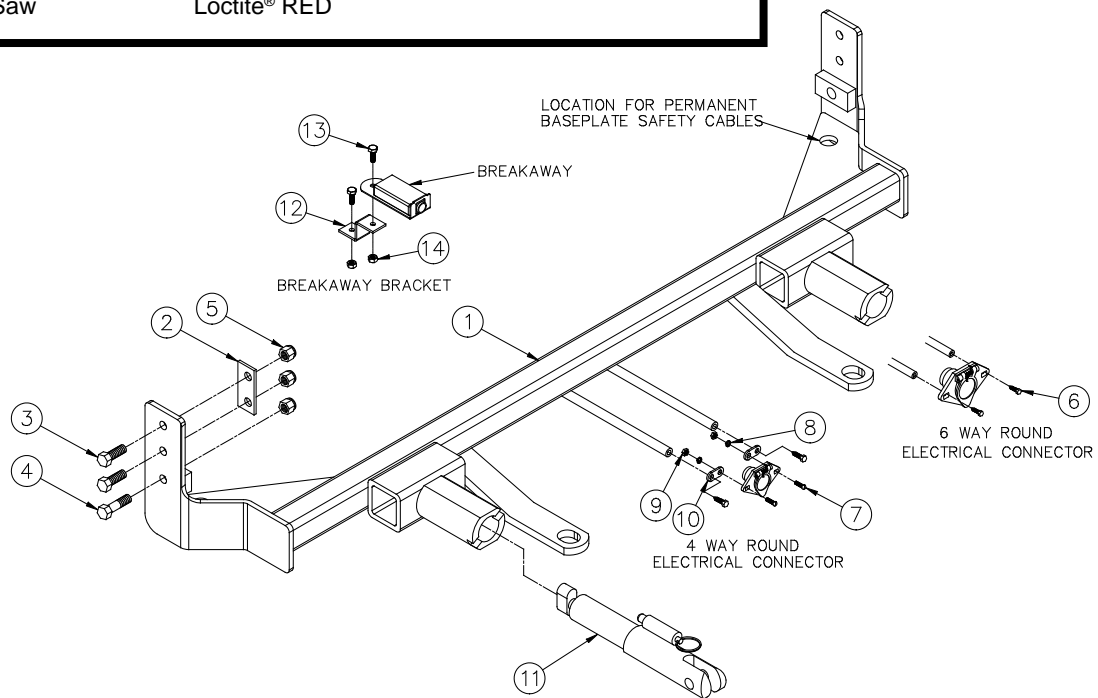

Important:

Use only genuine factory replacement parts on your baseplate. Do **NOT** substitute homemade or non-typical parts. If a bolt is lost or in need of replacement, for your safety and the preservation of your baseplate, be sure to use a replacement bolt of the same grade (In most cases it will be Grade 5, please reference the parts list above). Replacement parts may be ordered through your nearest Blue Ox® Dealer or Distributor. Failing to follow and/or altering these installation instructions in either installation or required equipment will void the manufacturer's warranty.

BX2253
2009-12 Honda Fit
(Includes Foglights)
Installation Instructions

Attachment Tabs: Due to the design of the removable tabs, the RangeFinder II tow bar can not be used. Adapters, except the BX8833 and Bx88151, can not be used with this baseplate.

Installation Notes: The fascia and metal bumper are removed for installation. Trimming of the air dam and the fascia is required. Drilling is required.

The dimensional variations between otherwise identical vehicles can be considerable. While the baseplate was designed for easy installation, it may be necessary to tailor the baseplate slightly to compensate for auto manufacturer's tolerances. These minor adjustments may include filing a hole slightly, bending electrical rods, or bending end plates.

The BX8869 Bulb and Socket Wiring Kit is recommended for this vehicle.



Possible location for the Bulb and Socket Wiring Kit (BX8869)

Handling of some cosmetic parts when installing this product may require the use of protective covers, rags, specialty tools, etc. to prevent damage.

Do not use the towed vehicle for storing luggage, equipment, etc. This may cause you to exceed the towing capacity of the tow bar, baseplate, and its accessories.

Installation Instructions

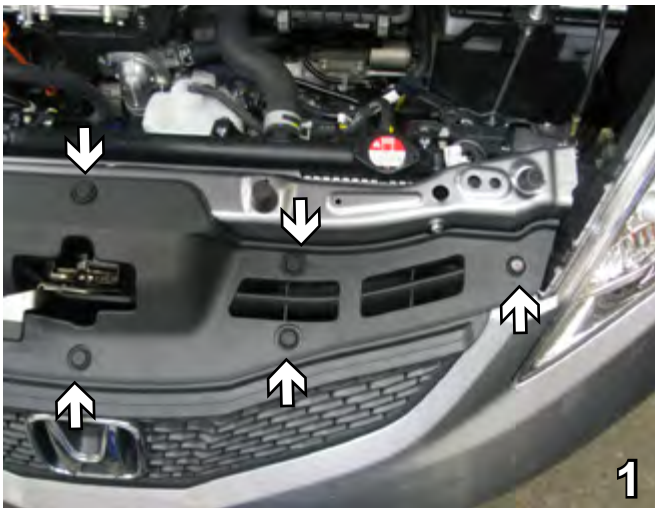

1. On top of the fascia, remove eight (8) push pins. Set push pins aside to be reinstalled later.
2. Just inside wheel well, on edge of fascia, use the Phillips screwdriver to remove one (1) screw. Do this to both sides of the vehicle. Set screws aside to be reinstalled later.

BX2253
2009-12 Honda Fit
(Includes Foglights)
Installation Instructions



3. Remove two (2) push pins from the bottom corner of the fascia. Do this to both sides of the vehicle. Set push pins aside to be reinstalled later.



4. Underneath in the center, remove three (3) push pins. Set push pins aside to be reinstalled later.



5. Using a Phillips screwdriver, remove two (2) screws holding the fascia. Do this to both sides of the vehicle. Set screws aside to be reinstalled later.

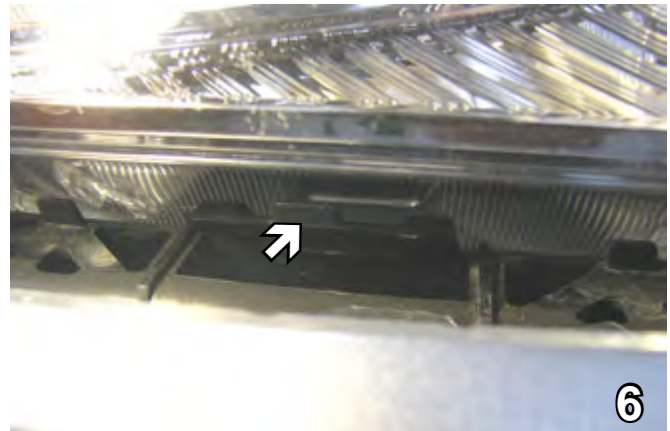

6. Use a flat screwdriver to gently pry the three tabs along the side of the vehicle. Underneath the headlight, slightly lift up the four (4) plastic tabs, one (1) at a time, as the fascia is removed. Do this to both sides of the vehicle. Carefully set the fascia aside.

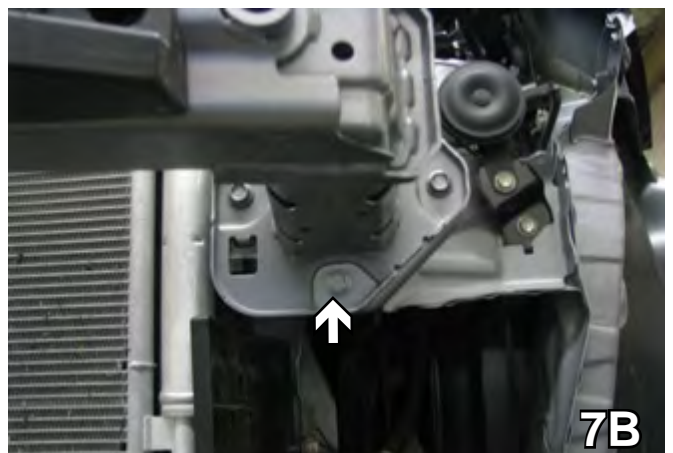
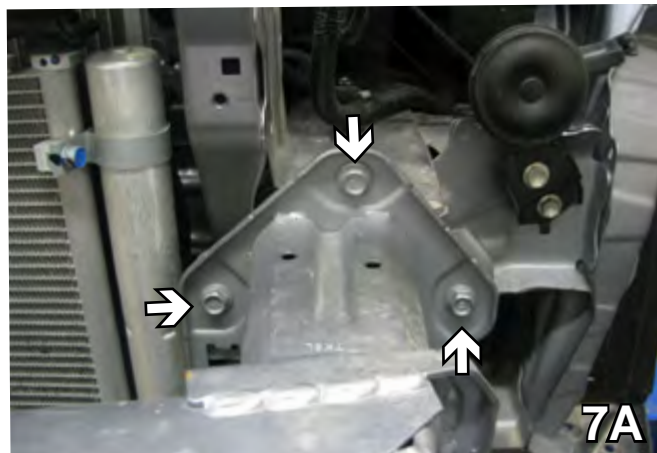

7. Using the 12MM socket, remove four (4) bolts from the metal bumper, three (3) on the top and one (1) on the bottom. Do this to both sides of the vehicle. Set bolts and metal bumper aside to be reinstalled later.

BX2253
2009-12 Honda Fit
(Includes Foglights)
Installation Instructions

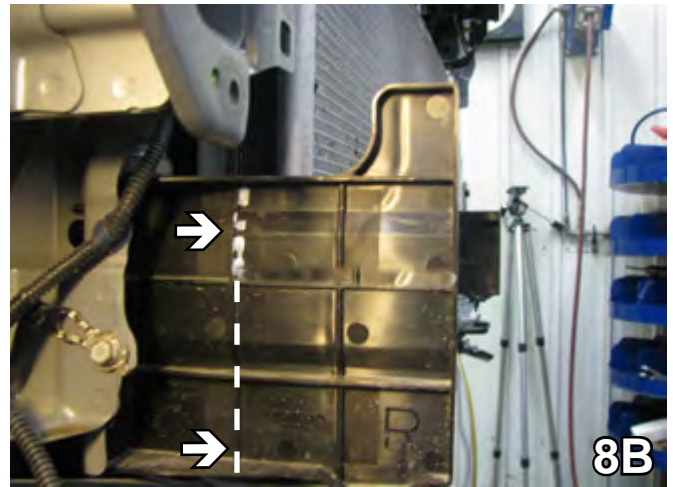
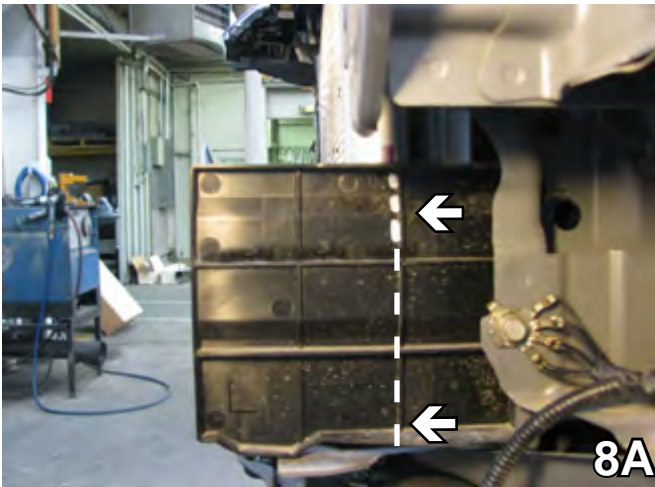

8. Using the utility knife, trim the air dam under the bumper on the driver's side as shown in 8A and the passenger side as in 8B.

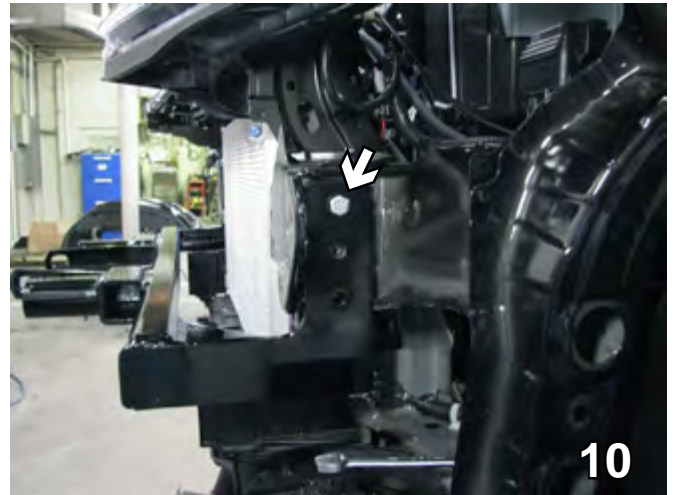

9. Using a 13/32" drill bit, drill out the top existing hole. Do this on both sides.
10. Slide the baseplate on and align with the top existing hole which has been drilled out. Fasten tight with a 1-1/4" bolt and 3/8" hex nut. Be sure the baseplate is level with the vehicle and this will effect how baseplate comes through fascia opening. Use the baseplate as a template to drill the other two holes. Do this on both sides.

When using power drills be aware of the dangers of torque and drill bit length.

BE SURE TO USE LOCTITE® RED ON ALL BOLTS BEFORE TIGHTENING. TIGHTEN ALL BOLTS ACCORDING TO THE TORQUE CHART ON THE FRONT PAGE OF THESE INSTRUCTIONS OR ON PAGE 3 OF THE BASEPLATE TOWING GENERAL INSTRUCTIONS.

BX2253
2009-12 Honda Fit
(Includes Foglights)
Installation Instructions

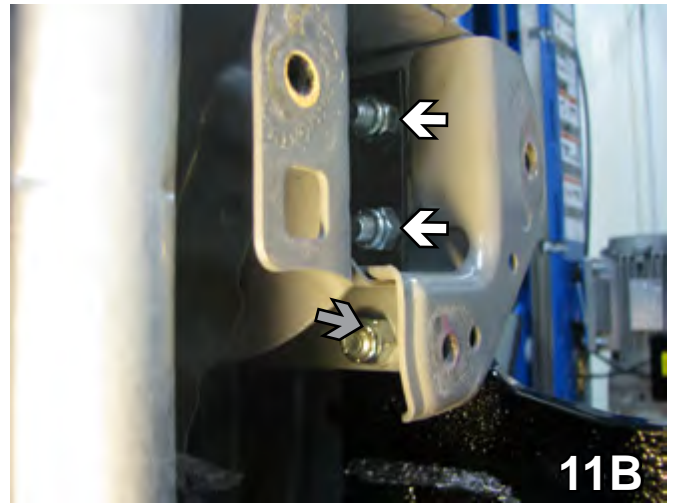
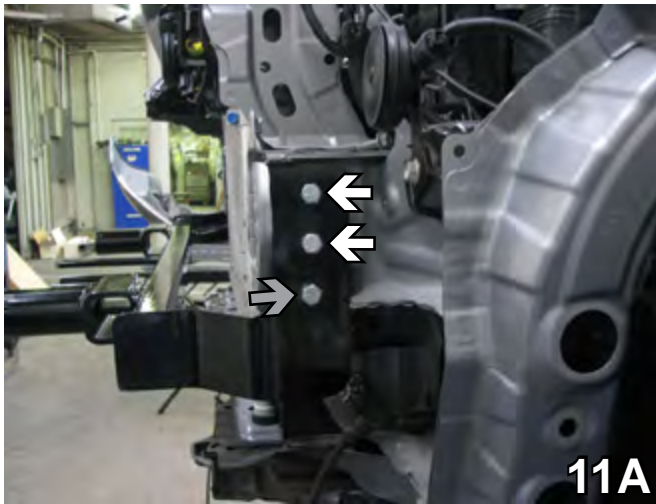

11. In the top two (2) holes, insert 1-1/4" bolts (11A white arrows). On the inside of the frame end, attach to a plate with the narrow end to the front with 3/8" lock nuts (11B white arrows). In the bottom hole, insert 1-1/2" bolts (11A gray arrow) and attach to 3/8" lock nuts underneath on the webbing (11B gray arrow). Use Loctite Red on all bolts. Do this on both sides.

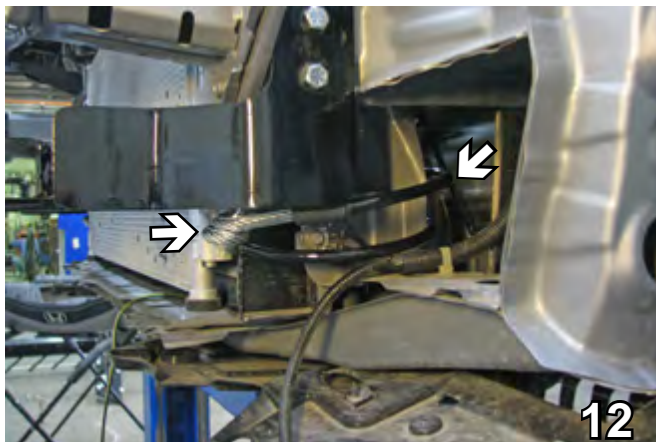

12. Attach the permanent baseplate safety cables to the provided convenience link on the baseplate. Secure the cable to a solid piece of the vehicle's frame as described in the instructions included with the permanent baseplate safety cables. Do this on both sides.
13. Reinstall the bumper, bolts, push pins and screws.

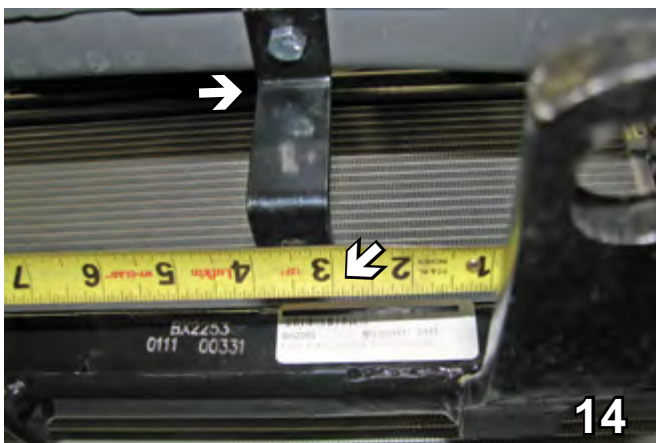

14. Attach the breakaway bracket to the bottom of the bumper 3" to the inside of the convenience link. Use a 1/4"-20 x 3/4" hex bolt with a 1/4"-20 hex nut. Attach the breakaway to the bracket with a 1/4"-20 x 3/4" hex bolt and a 1/4"-20 hex nut.

BX2253
2009-12 Honda Fit
(Includes Foglights)
Installation Instructions

2009 - 2011 Models

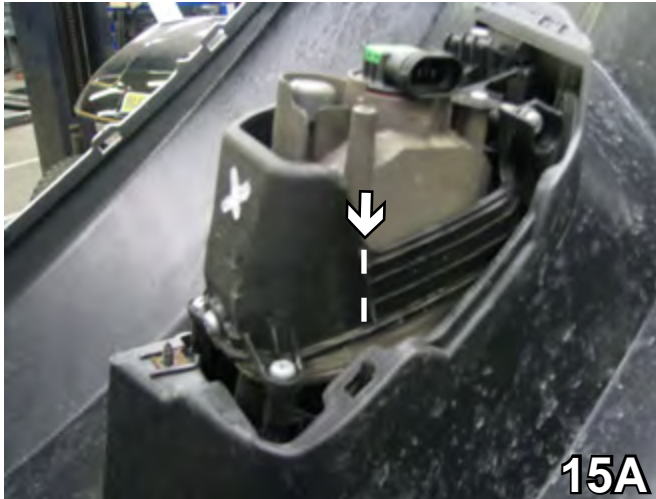

2012 Models



15. Trim foglights as shown above for your particular year of vehicle. Pictures 15A and 15C show area to be trimmed and pictures 15B and 15D show the foglights with the trimming completed.

BX2253
 2009-12 Honda Fit
 (Includes Foglights)
 Installation Instructions

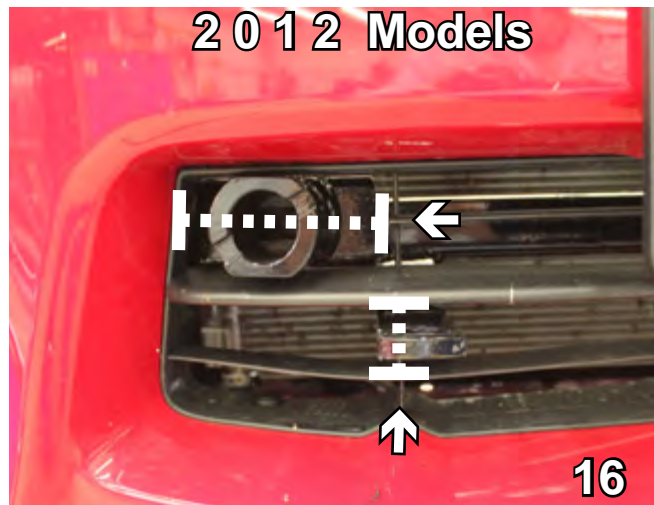
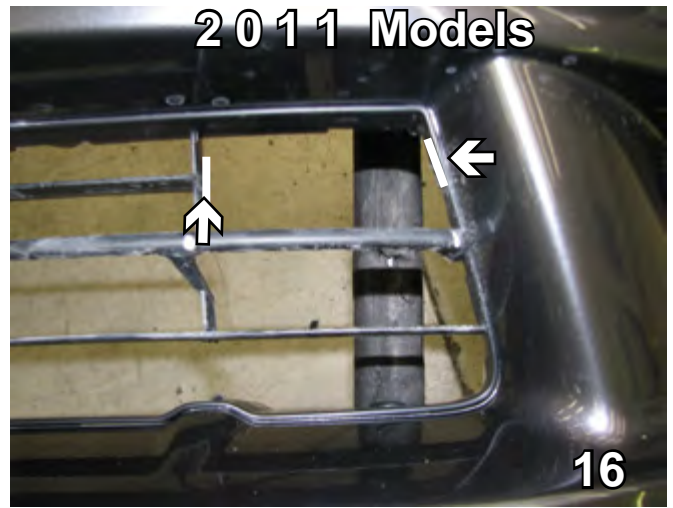
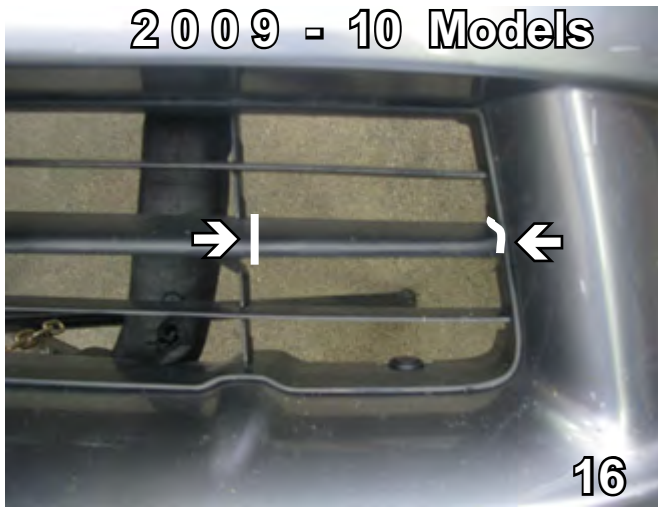

16. Hold fascia up to its original position and mark area to cut. Photos show approximate cut locations. Cut fascia rib with utility knife. Do this to both sides.



17. Reinstall the fascia.

Install the tow bar and safety cables according to the instructions provided in their packages. When demonstrating this to the customer, be sure to include all the contents and packages.

Do **NOT** substitute other devices if the tow bar pins and clips are misplaced.

Be sure that **ALL** electrical connections are plugged in properly and functioning **BEFORE** installing the fascia.

DEALER or INSTALLER:
 Be certain the user receives the instruction sheets for their products.

BX2253
2009-12 Honda Fit
(Includes Foglights)
Installation Instructions



2009 - Shown with removable tabs installed



2011-Shown without removable tabs installed



2012 - Shown with removable tabs installed

If the baseplate is in an accident, it must be replaced. DO NOT use it again! An accident can cause unseen damage and using it again could result in more damage or serious injury. DO NOT use the baseplate if it is damaged or missing parts.

CUSTOMER SERVICE COMMITMENT

Blue Ox is committed to providing you with exceptional customer care throughout your lifetime with our products. Our team is here to assist you with any questions you may have regarding the performance of your product. Simply call (402) 385-3051 and you can speak with our customer care team.

Additionally, please visit our website to see which rallies our Destination America team will be attending. For a nominal fee, our service technician will service your towing system to ensure it's in proper working condition. Also, as a commitment to our customers, should you visit our factory, you can stay at our full service Blue Ox campground at no charge along with enjoying a factory tour.

Again, thank you for being our customer and for the confidence you have shown in the performance of our products. It is because of customers like you we enjoy the success we have today.



© 2011 Blue Ox
One Mill Road, Industrial Park
Pender, Nebraska 68047
Phone: (402) 385-3051
Fax: (402) 385-3360
www.blueox.com