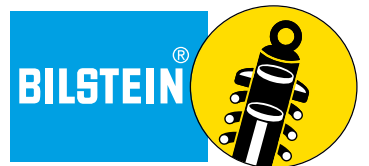


B8 8125 TECHNICAL MANUAL.



INTRODUCTION.

BILSTEIN introduced the very first monotube gas pressure shock absorber to the extremely challenging world of off-road racing and it didn't take long for racers to recognize the superior performance this new technology provided. With no emulsion and no foam cells, the BILSTEIN monotube provides consistent damping for ultimate vehicle control in even the roughest terrain.

After 40 years of evolving monotube shock technology, BILSTEIN continues to deliver race-winning products to the world of off-road racing— and the all-new BILSTEIN B8 8125 Series is no exception. Designed for the serious off-road enthusiast, the BILSTEIN B8 8125 Series provides custom coilover applications with competition-level performance.



GETTING STARTED.



Prior to getting started, please read the information below as it is important to maintaining the life and performance of your shocks. Do not attempt to disassemble or assemble your shocks without proper tools or technical knowledge.

OWNER REBUILDABLE

The B8 8125 Series are fully owner rebuildable and revalvable. Any component can be purchased through a BILSTEIN dealer or direct from BILSTEIN. Owner rebuildable shocks can also be revalved and serviced by BILSTEIN. BILSTEIN Off-Road Department can be contacted direct at 1-800-537-1085 for parts, service or technical questions.

GAS PRESSURE - USE NITROGEN ONLY!

B8 8125 Series uses nitrogen which requires regular service. Failure to service your shock will reduce the life span and damage the shock absorber.

If the suspension begins to feel soft, you may need to increase nitrogen pressure. Nitrogen can be serviced through a Schrader™ valve located on the reservoir end cap. A BILSTEIN Gas Filling Tool (*Part #193000*) is available. Please contact a BILSTEIN dealer for more details. Nitrogen bottles typically can be purchased at a welding supply store.

- B8 8125 Series are delivered with 200 PSI nitrogen pressure.
- Proper fill level range is from 180-200 PSI.

INSTALLATION

B8 8125 Series are not intended for use on any OEM applications, and will not fit directly in OEM mounting locations. Incorrect installation can lead to the failure of this product. The user is responsible for determining the suitability of these products. Below are a few tips:

- A limit strap is strongly recommended on any high-speed application where suspension oscillations to “full droop” are a common occurrence.
- The B8 8125 Series are supplied with (4) heim spacers, of which (1) must be placed on both sides of the spherical bearing (top and bottom). The purpose of these spacers is to allow the spherical bearing to articulate as the shock cycles through its travel. It is very important that the heim spacers, or any part of the mount brackets, etc., do not contact the end loop during operation. Any interference with the free movement of the bearings may result in a bent or broken piston rod.
- It is very important to cycle the suspension to “full bump” and “full droop” before operating the vehicle with this product. Failure can occur if the shock body comes in contact with the chassis, tire and wheel, or suspension of the vehicle.

COILOVER HARDWARE

B8 8125 Series are equipped with dual-rate spring hardware on most models. This consists of a bottom spring hat, a spring slider, (2) spring crossover nuts, and an upper spring seat. The spring seat and the spring crossover nuts are installed in the proper orientation.

SPRING SEAT

The upper spring seat is threaded and can be used to adjust spring preload. Rotating the spring seat clockwise will increase preload (lift), while rotating counter clockwise will decrease preload (lower). It's recommended to only adjust spring preload when the suspension is fully unloaded. This will make the operation much easier. If the spring seat cannot be rotated by hand, use a standard 3/8" center punch, placed in the holes, to improve leverage. Once the spring preload is set you can lock the spring seat into position by tightening the socket head bolt.

SPRING CROSSOVER NUTS

Positioned above the spring slider and below the upper spring seat, the crossover nuts are used to adjust the transition moment from the softer combined dual rate spring to the stiffer single rate. These nuts can be rotated clockwise and counter clockwise to adjust for the desired spring transition. Rotating the crossover nuts against each other will lock them into place.

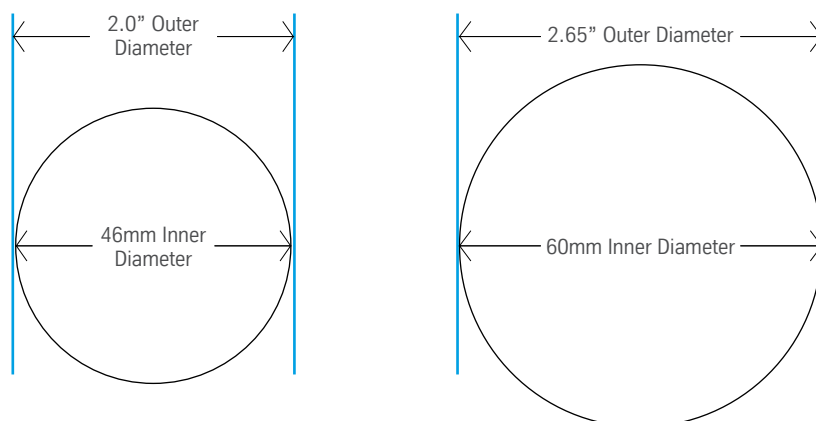
COILOVER SPRINGS

The B8 8125 Series use industry standard coilover springs. A 46mm(2.0") diameter shock absorber uses a 2.5" ID coil and a 60mm(2.65") diameter shock absorber uses a 3" ID coil. It is important that the bottom coil, on the dual rate set up, be at least as long as the shock travel (Example: A 12" travel shock should use a lower spring at a minimum length of 12"). To install the springs, first slide the upper spring into position, install the slider, install the lower spring and then install the lower spring hat. Shorter travel 5", 6", and 8" B8 8125 Series will only have a single rate hardware kit. For these models install the single spring and then install the lower spring hat.

ZINC-PLATED FINISH

B8 8125 Series feature a proprietary BILSTEIN zinc plated finish. This finish must be serviced in order to maintain its luster. Particularly in moist climates, a protective coating, such as a wax or lubricating oil should be periodically applied to prevent tarnishing. This finish is not covered under warranty.

HOW TO MEASURE YOUR SHOCK ABSORBER



WARRANTY

LIMITED 90 DAY WARRANTY

BILSTEIN warrants to the original retail purchaser that, for a period of ninety (90) days from the date of purchase, this product shall be free from defects in material and workmanship. Any implied warranty of merchantability, fitness or fitness for particular purpose, except as may be prohibited by applicable law, is likewise limited in duration to ninety (90) days from the date of original retail purchase. Some states do not allow limitations on how long an implied warranty lasts so the above limitation may not apply to you.

This warranty is non-transferable and does not cover normal wear and tear or any other loss, liability or damage resulting from improper alteration, disassembly, handling, installation, service, repair or use of this product. Should this product fail as a result of a defect in materials or workmanship within the warranty period, contact BILSTEIN's Customer Service Department by telephone at 1-800-537-1085, or in writing at thyssenkrupp BILSTEIN of America 14102 Stowe Drive, Poway, California 92064 for repair or replacement at manufacturer's option.

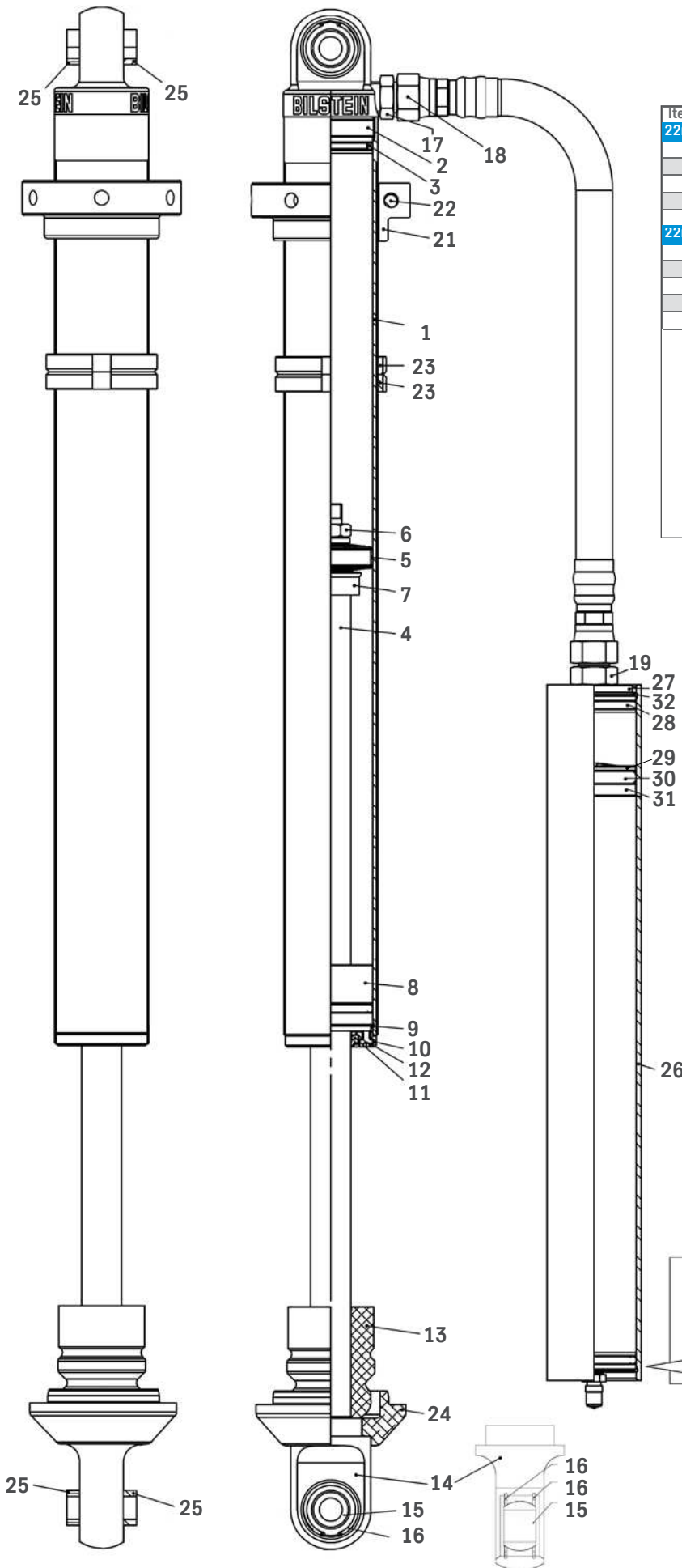
Repair or replacement as provided by this warranty is customer's sole and exclusive remedy in the event of a product failure. Manufacturer shall not be liable for any incidental, consequential or other damages resulting from the disassembly, handling, installation, service, repair or use of this product. Some states do not allow the exclusion or limitation of incidental or consequential damages, so the above limitation may not apply to you. This warranty gives you specific legal rights, and you may also have other rights which vary from state to state.



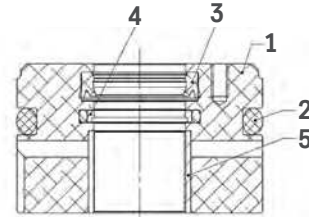


TABLE OF CONTENTS.

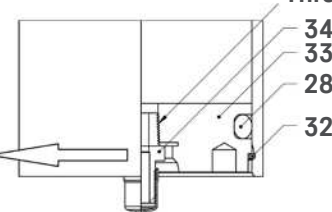
B8 8125 Components Illustration	8
Illustration.....	8
Components	9
Technical Guide.....	10
Seal Kits - 60mm 46mm	11
Piston Rod Assembly Removal.....	12
Rod Guide Reseal.....	14
Piston Wear Band Replacement	18
Rod Guide and Valving Installation	19
Draining the Oil.....	20
Reservoir Reseal	21
a. Disassembly.....	21
b. Assembly.....	25
Filling the Oil	29
Installing the Piston Rod	30
Pressurizing the Shock Absorber	32
Additional Procedures.....	33
Revalving.....	33
Heim Replacement.....	36
Rod End Removal and Replacement.....	38
Changing the Hose	39
Valving Chart.....	40
Oil Volume Chart	41
Parts List.....	42
Valving Tracking Worksheet	46



Item #	Description	Part #	QTY.
22mm x 60mm Rod Guide Assembly			
1	Rod Guide Housing	E4-FU2-Z047A00	1
2	O-Ring	1000406	1
3	Rod Seal, 22mm	194432	1
4	Seal, single step w/ O-Ring	E4-B36-364	1
5	Rod Guide Bushing 22x20mm	E4-LB1-Z015A00	1
22mm x 46mm Rod Guide Assembly			
1	Rod Guide Housing	E4-FU2-Z046A00	1
2	O-Ring	E4-D16-Z026A00	1
3	Rod Seal, 22mm	194432	1
4	Seal, single step w/ O-Ring	E4-B36-364	1
5	Rod Guide Bushing 22x20mm	E4-LB1-Z015A00	1



LOCTITE #271
Threadlocker



Item #	Description	Part # (60mm)	Part # (46mm)	QTY.
Shock Components				
1	Tube	See Table A	See Table A	1
2	End Cap	E4-LG0-Z025A00	E4-LG0-Z024A00	1
3	O-Ring	1000406	E4-D16-Z026A00	1
4	Piston Rod	See Table A	See Table A	1
5	Piston Band	E4-KR2-Z017A00	E4-KR2-X001A02	1
6	Piston Nut	E4-MU1Z015A01	E4-MU1-Z015A01	1
7	Internal Spacer	E4-RO3-Z111A03	E4-RO3-Z11A01	1
8	Rod Guide Assy.	B4-VS3-Z009A00	B4-VS3-Z008A00	1
9	Snap Ring	E4-BOA-0000130	E4-B46-26	1
10	Wiper Cap	E4-SB6-Z092A01	E4-SB6-Z091A01	1
11	Wiper	194044	194044	1
12	Screw M4X12	412CCSS	412CCSS	3
13	Jounce Bumper	E4-AP2Z075A03	E4-AP2-Z133A00	1
14	Bearing Carrier	E4-LG5-Z007A00	E4-LG5-Z007A00	1
15	Spherical Bearing	E4-GL1-Z017A00	E4-GL1-Z017A00	1
16	Retaining Ring	E4-SP1-Z014A01	E4-SP1-Z014A01	2
17	Adapter	2021-8-8S	2021-6-8S	1
18	Hose Assy.	B4-XA0-Z005A01	B4-XA0-Z005A01	1
19	Self Locking SHCS	1001025	1001025	1
20	Reservoir Assy.	B4-RV3-Z004A08	B4-RV3-Z005A03	1
21	Spring Seat	E4-FT4-Z043A00	E4-FT4-Z044A00	1
22	Self Locking SHCS	1001341	1001341	1
23	Spring Stop	E4-FT4-Z045A00	E4-FT4-Z044A00	2
24	Spring Hat	E4-FT3-Z050A00	E4-FT3-Z049A00	1
25	Heim Spacer	E4-RO4-Z016A32	E4-RO4-Z016A32	4
Reservoir Assembly: B4-RV3-Z004A08 (60mm), B4-RV3-Z005A03 (46mm)				
26	Reservoir Tube	E4-R01-Z134A03	E4-R03-Z112A00	1
27	ORB End Cap	E4-FU0-Z017A01	E4-FU0-Z020A00	1
28	O-Ring - End Cap	1000406	E4-D16-Z026A00	2
29	Div. Piston	B4-TK6-Z003A00	B4-TK3-Z003A02*	1
30	O-Ring - Div. Piston	E4-BOA-0000450		1
31	Piston Band	E4-KR2-X017A00		1
32	Snap Ring	E4-BOA-0000130	E4-B46-26	2
33	Reservoir End Cap	E4-FU0-Z017A02	B4-B0A-0000016	1
34	Schrader™ Valve Assy.	B4-XD0-Z006A01	B4-XD0-Z006A01	1

Table A

Shock Part #	Replacement Shock Tube	Replacement Piston Rod
33-225463	E4-R00-Z021A00	E4-KS2-Z065A00
33-225487	E4-R00-Z021A01	E4-KS2-Z065A01
33-225500	E4-R00-Z021A02	E4-KS2-Z065A03
33-225524	E4-R00-Z021A03	E4-KS2-Z065A05
33-225548	E4-R00-Z021A04	E4-KS2-Z065A07
33-225562	E4-R00-Z021A05	E4-KS2-Z065A09
33-225586	E4-R00-Z021A06	E4-KS2-Z065A11
33-225494	E4-R00-Z022A02	E4-KS2-Z065A03
33-225517	E4-R00-Z022A03	E4-KS2-Z065A05
33-225531	E4-R00-Z022A04	E4-KS2-Z065A07
33-225555	E4-R00-Z022A05	E4-KS2-Z065A09
33-225579	E4-R00-Z022A06	E4-KS2-Z065A03
33-225593	E4-R00-Z022A07	E4-KS2-Z065A05
33-225616	E4-R00-Z022A08	E4-KS2-Z065A07
33-225630	E4-R00-Z022A09	E4-KS2-Z065A09
33-225654	E4-R00-Z022A10	E4-KS2-Z065A11

*46mm div. piston is complete with o-ring

TECHNICAL GUIDE.



WARNING!

Please review complete manual before beginning any disassembly.



B8 8125 TOOL BOX:

- Pick Set
- 3mm Socket Head Wrench
- Ratchet with 3/4" Socket
- 7/8" Box Wrench
- Face Spanner Wrench
- Torque Wrench (inch lbs)
- Oil Containment Bucket
- 5/8" Round Pry Bar
- Hammer
- Snap Ring Pliers
- 271 Red Loctite
- White Lithium Grease
- Propane Torch
- Tabletop Vise
- Nitrogen
- Table Arbor Top Press
- Soft Jaw (Radius or Triangle Interface)
- Schrader™ Core Removal Tool
- Large Adjustable Open End Wrench

FULL SERVICE REBUILD:

A full service rebuild will restore the performance of your shock absorber. This procedure is broken down into 9 sub-steps listed below. Please review the required tools above and complete instructions prior to disassembly. It is important to perform this procedure in a clean, dry environment to keep contaminants out of the shock internals.

1. Piston Rod Assembly Removal
2. Rod Guide Reseal
3. Piston Wear Band Replacement
4. Rod Guide and Valving Installation
5. Draining the Oil
6. Reservoir Reseal:
 - a. Disassembly
 - b. Assembly
7. Filling the Oil
8. Installing the Piston Rod
9. Pressurizing the Shock Absorber

Additional Procedures:

1. Revalving
2. Heim Replacement
3. Rod End Removal and Replacement
4. Changing the Hose

SEAL KITS - 60MM | 46MM.



Before starting, you must determine if you have a 60mm or 46mm shock (refer to section: How to Measure Your Shock Absorber, page 4) and purchase the appropriate seal kit. Seal kits include all rod guide seals and reservoir components.

60mm Seal Kit: Part# B4-KT0-Z024A01

46mm Seal Kit: Part# B4-KT0-Z023A01

60mm Rod Guide Seals:



46mm Rod Guide Seals:



60mm Reservoir Components:

Reservoir End Cap O-Ring (x4):



Dividing Piston O-Ring:



Piston & Dividing Piston Wearband (x2):



46mm Reservoir Components:

Reservoir End Cap O-Ring (x4):



Dividing Piston (Complete):



Piston Wearband:



PISTON ROD ASSEMBLY REMOVAL.

STEP 1

Place shock upside down in vise and clamp on eyelet.



Use a buffering layer between the clamp and eyelet, such as a towel, to avoid scratching the anodized end cap.



STEP 3

Using a 3mm socket head wrench, remove the 3 socket head screws from the rod guide.



STEP 2

Using pick, release all gas pressure and remove Schrader™ core.



IMPORTANT!

Do not collapse the piston rod once the gas pressure is extinguished.



STEP 4

Slide black wiper cap up the piston rod, revealing the rod guide below.



STEP 5

Depress rod guide down revealing the snap ring.



Snap Ring

STEP 6

Using a pick, remove the snap ring from inside the shock body.

**STEP 7**

Carefully remove piston rod assembly from the shock body.



If the assembly cannot be pulled out of the shock body by hand, place a 5/8" round pry bar horizontally into the eyelet and use a hammer to strike the pry bar upwards.

ROD GUIDE RESEAL.



Before starting, you must determine if you have a 60mm or 46mm shock (refer to section: How to Measure Your Shock Absorber, page 4) and purchase the appropriate seal kit. Seal kits include all rod guide seals and reservoir components (shown on page 11).

60mm Seal Kit: Part# B4-KT0-Z024A01

46mm Seal Kit: Part# B4-KT0-Z023A01



60mm Rod Guide Seals



46mm Rod Guide Seals

STEP 1

Clamp rod end in vise.



STEP 2

Remove rod nut using 3/4" socket or open-end wrench.



Use a buffering layer between the clamp and eyelet, such as a towel, to avoid scratching the rod-end.

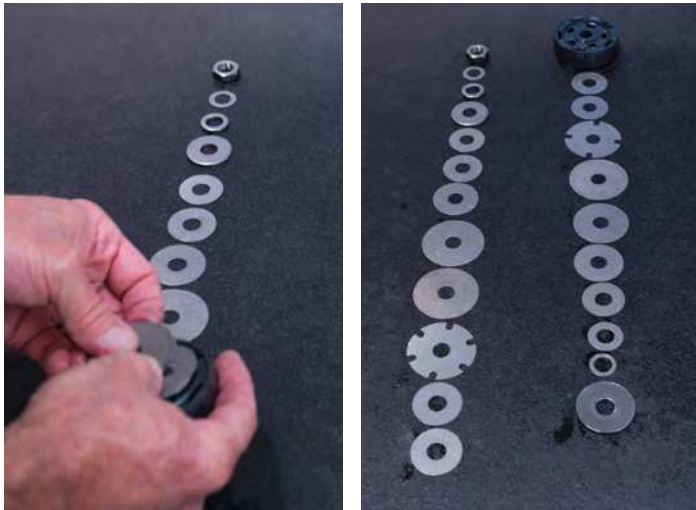
STEP 3

Remove valving discs and piston from rod.



IMPORTANT!

To maintain performance, it is imperative that the valve discs and components are removed and replaced in the precise order that they were removed. We suggest laying out the compression valve stack, piston, and rebound valve stack in order.



STEP 4

Remove rod guide from piston rod.



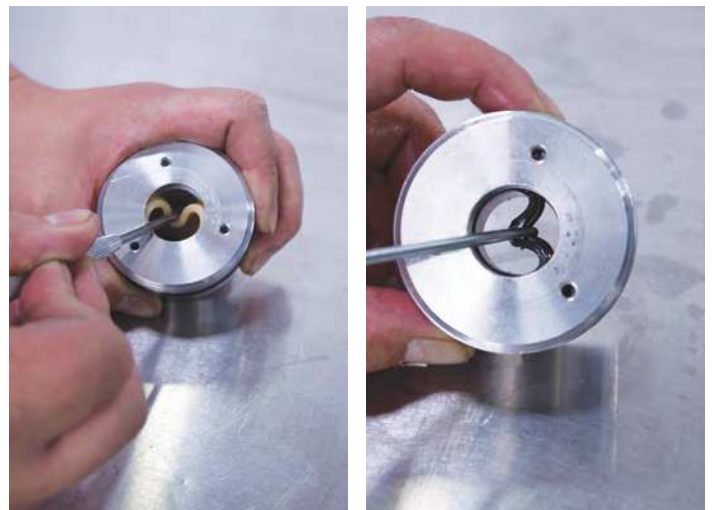
STEP 5

Remove wiper cap from piston rod.



STEP 6

Using a pick, remove all five seals from the rod guide and wiper cap.



STEP 6 - CONTINUED



STEP 7

Install o-ring (brown) in lower groove inside rod guide.



O-Ring

STEP 8

On the high pressure step seal, identify the step.



STEP 9

Making sure the smallest ID of the step faces up, bend the high pressure step seal and carefully install in same lower groove, covering the brown o-ring in step 7.



High pressure seal shown upside-down to illustrate the different steps and internal diameters(IDs).

STEP 10

Identify the location of the groove on the cup seal.



Illustrated groove will be installed inside the rod guide facing down.

STEP 11

Install cup seal with groove portion facing down.



Fold seal in the middle and carefully install in upper groove.

STEP 12

Install wiper seal in wiper cap.



STEP 13

Coat external o-ring with white lithium grease and install in outer groove of rod guide.



PISTON WEAR BAND REPLACEMENT.



Before starting, you must determine if you have a 60mm or 46mm shock (refer to section: How to Measure Your Shock Absorber, page 4) and purchase the appropriate wear band:

60mm Piston: E4-AK1-Z050A00

Wear Band: E4-KR2-X017A00

46mm Piston: E4-B46-205NDT

Wear Band: E4-KR2-X001A02

STEP 1

Remove old wear band using a pick.



STEP 2

Install new wear band.



ROD GUIDE AND VALVING INSTALLATION.

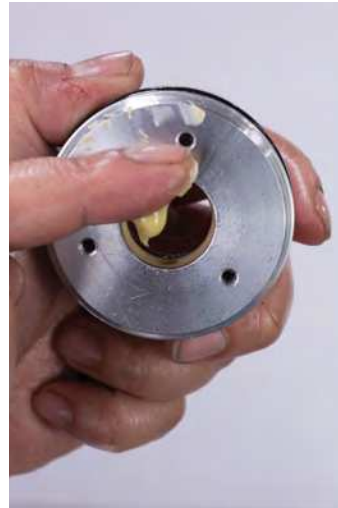
STEP 1

Install wiper cap on piston rod.



STEP 2

Lightly lubricate the inside of the rod guide with white lithium grease and install the rod guide on the piston rod.



STEP 3

Install valving discs and piston on the piston tennon in the order that it was removed in step 3 of section: Rod Guide Reseal, page 15.



STEP 4

Place a dab of 271 red Loctite on rod nut and install. Torque to 250 inch pounds.



DRAINING THE OIL.

STEP 1

Remove the shock body from the vise and drain oil into oil safe container.



Please obey all environmental regulations when disposing of oil.



Raise reservoir higher than the shock body to drain all the oil contents from both the reservoir and shock body.

RESERVOIR RESEAL - DISASSEMBLY.



WARNING!

Must release gas pressure and complete section Piston Rod Assembly - Removal, page 12-13, before continuing.

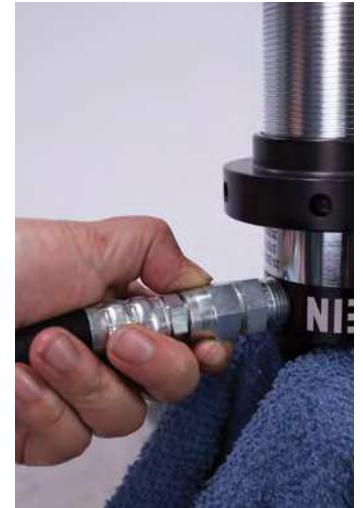
STEP 1

Place shock body upside down in vise and clamp on eyelet.



STEP 2

Remove reservoir hose from shock body using a 7/8" open-end wrench. Once the nut is loose, continue to unscrew by hand.



Use a buffering layer between the clamp and eyelet, such as a towel, to avoid scratching the anodized end cap.

STEP 3

Lightly clamp reservoir tube in vise using buffering layer to prevent surface damage. Remove reservoir hose from end cap using (2) 7/8" wrenches.



STEP 4

Depress end cap into reservoir body by hand or lightly tap with rubber mallet to reveal inner snap ring.



STEP 5

Remove inner snap ring using pick.



STEP 6

Remove cap.



Screw hose onto the fitting, hand tighten, and pull up.

STEP 7

Turn reservoir upside-down in vise and depress Schrader™ end cap revealing inner snap ring.



If the Schrader™ end cap will not move when depressing by hand, use a rubber mallet and lightly tap to depress.

STEP 8

Remove inner snap ring using pick.



STEP 9

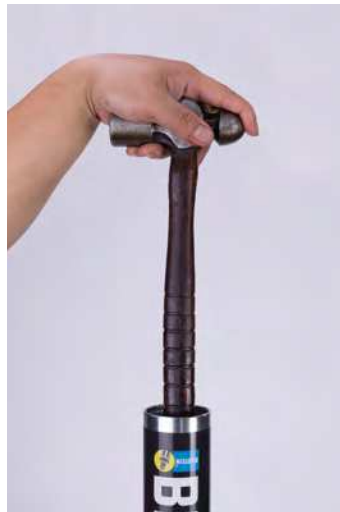
Turn reservoir right-side up and lightly clamp in vise. Using the rubber mallet handle, begin tapping the dividing piston down. This will remove the Schrader™ valve end cap and the dividing piston from the reservoir.



If the rubber mallet handle is not long enough, use a piece of PVC pipe that is the correct length.

IMPORTANT!

As you tap the parts down, make sure to catch the Schrader™ valve end cap and the dividing piston from the opposite end of the reservoir so they do not fall onto the ground.

**STEP 10**

Remove o-ring from Schrader™ end cap using pick.

**STEP 11**

60mm - Remove o-ring from dividing piston using pick.
46mm - New dividing piston comes complete. Discard and replace with new part. *Continue to Step 13.*



STEP 12

Remove wear band from dividing piston.



STEP 13

Remove o-ring from reservoir end cap using pick.



RESERVOIR RESEAL - ASSEMBLY.



Before starting, you must determine if you have a 60mm or 46mm shock (refer to section: How to Measure Your Shock Absorber, page 4) and purchase the necessary components. All seals and components are included in the seal kits shown on page 11, or can be purchased separately using part numbers below.

60mm Seals:

Reservoir End Cap O-Ring (x4):



Dividing Piston O-Ring:



Piston & Dividing Piston Wearband (x2):



46mm Seals:

Reservoir End Cap O-Ring (x4):



Dividing Piston (Complete):



Piston Wearband:



STEP 1

46mm & 60mm - Install new o-ring on Schrader™ end cap. Use white lithium grease on o-ring to aid in installation.



STEP 2

46mm & 60mm - Install new o-ring, on reservoir end cap. Use white lithium grease on o-ring to aid in installation. Continue on to step 3 (60mm) or step 5 (46mm).



STEP 3

60mm - Install new wear band on dividing piston.



STEP 4

60mm - Install new o-ring on dividing piston. Use white lithium grease on o-ring to aid in installation.



STEP 5

46mm & 60mm - Install dividing piston in shock with the wear band towards the nitrogen chamber (facing down).

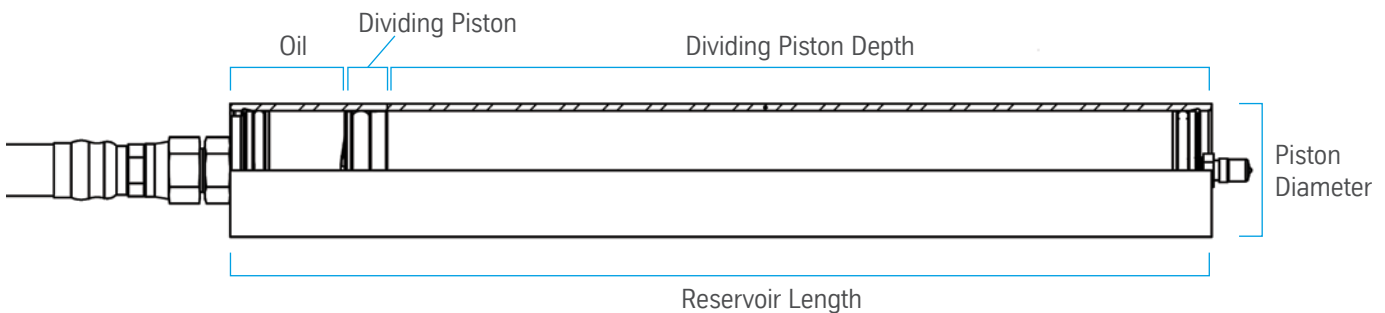


STEP 6

Position the dividing piston inside the nitrogen chamber according to the chart below. This step is critical to ensure the nitrogen chamber has the proper volume.

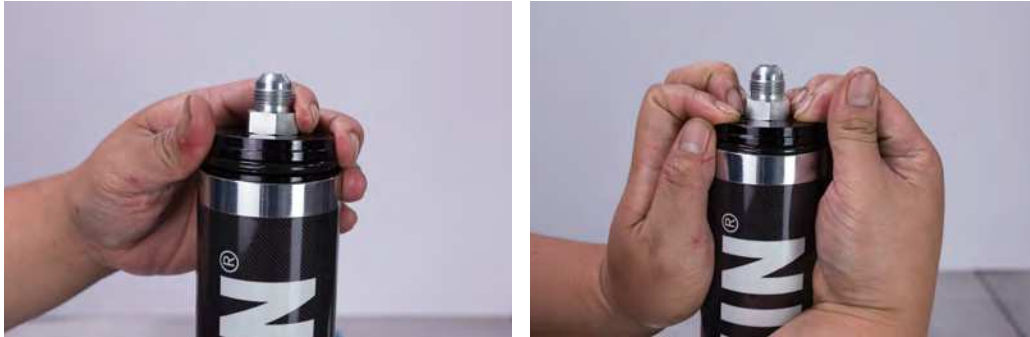


Piston Diameter	Reservoir Length	Dividing Piston Depth
46mm	254mm	193mm
46mm	381mm	320mm
60mm	305mm	220mm



STEP 7

Install reservoir end cap in reservoir tube and depress downwards so it is right below the inner snap ring groove.

**STEP 8**

Install inner snap ring and confirm it is seated properly inside snap ring groove.

**STEP 9**

Install hose on reservoir end cap and hand tighten.

**STEP 10**

Grasping the hose, pull end cap towards snap ring. Inspect assembly to assure the snap ring is properly seated.



STEP 11

Tighten hose using two 7/8" box wrenches.



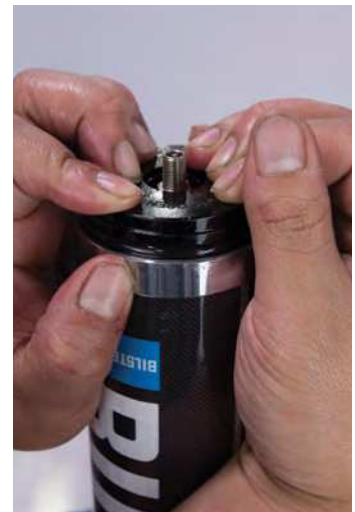
STEP 12

Flip the reservoir upside-down in vise and install Schrader™ end cap so that it is positioned right below the inner snap ring.



IMPORTANT!

Make sure the Schrader™ core is removed.



STEP 13

Install inner snap ring and confirm it is seated properly inside snap ring groove.



FILLING THE OIL.

STEP 1

Placing shock body upside down in vise, attach reservoir hose and tighten using a 7/8" box wrench.



Use a buffering layer between the clamp and eyelet, such as a towel, to avoid scratching the anodized end cap.

STEP 2

Fill oil into open end of the shock body. Use the proper oil volume by referencing the chart on page 41.



STEP 3

Loosen vise and lean shock at an approximate 10 degree angle and retighten vise. Allow several minutes for the air bubbles to surface and dissipate. When the air has purged from the oil, there should be an approximate 45-60mm gap between the oil and the end of the shock body. Once the oil has stabilized, move onto the next section (Installing the Piston Rod).



INSTALLING THE PISTON ROD.

STEP 1

Coat the o-ring on the rod guide with white lithium grease and with the piston rod fully extended, carefully push piston and rod guide into the shock body. It is OK if oil purges out the side vent of the rod guide.



Rod guide vent



STEP 2

Install internal snap ring and confirm it is seated properly inside snap ring groove.



STEP 3

Pull up on rod guide to properly seat against the snap ring.



STEP 4

Slide down wiper cap and align the 3 holes.

**STEP 5**

Using a dab of 271 red Loctite, install the 3 screws and tighten with 3mm socket head wrench.



PRESSURIZING THE SHOCK ABSORBER.

STEP 1

Install Schrader™ Core.



STEP 2

Pressurize with nitrogen to desired level.



IMPORTANT!

B8 8125 Series are delivered with 200 PSI nitrogen pressure. Proper fill level range is from 180-200 PSI.

REVALVING.

STEP 1

Remove piston rod assembly from shock body and fasten rod end in vise. (Refer to the section: Piston Rod Assembly Removal, page 12)



STEP 2

Remove 3/4" rod nut using an open end wrench.



Use a buffering layer between the clamp and rod end, such as a towel, to avoid scratching the rod end.

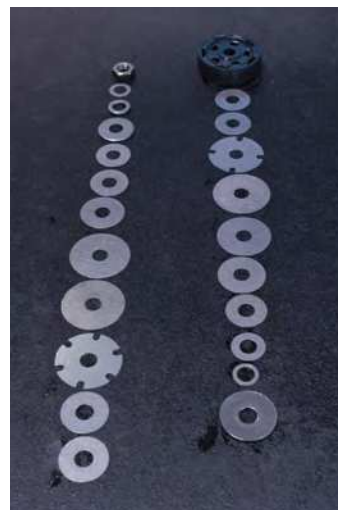
STEP 3

Carefully lay out valving on a clean surface in the order it was removed.



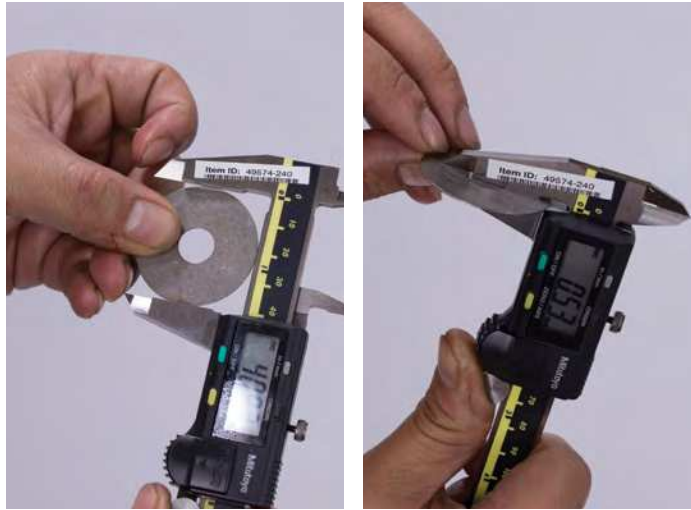
IMPORTANT!

To maintain performance, it is imperative that the components are removed and replaced in the precise order that they were removed. Additionally, take note of piston direction for correct installation.



STEP 4

Determine which valve plates need to be changed and exchange plates in the layout.



It's always a good practice to measure each shim to assure proper valving. In addition, utilizing a valving worksheet will help keep track of changes. See page 46 for a usable valving worksheet.

STEP 5

Clean piston rod tennon with a clean dry towel.

**STEP 6**

Reinstall valve plates on piston rod tennon in the order that they were removed.



Refer to section Valving Chart, page 40, for valving chart and diagram.

STEP 7

Place a dab of 271 red Loctite on piston rod nut.

**STEP 8**

Install piston rod nut and torque to 250 inch pounds.

**STEP 9**

Carefully reassemble piston rod assembly in shock body.



HEIM REPLACEMENT.

STEP 1

Using snap ring pliers, remove snap ring from both sides on the rod end.



STEP 2

Using table press, remove heim joint.



Two sockets may be used on either side of the rod end to remove heim joint using a table press. The lower socket must be large enough for the heim to drop into.

STEP 3

Reinstall snap ring on one side of the rod end.



STEP 4

Install new heim in eyelet.



STEP 5

Reinstall second snap ring.



ROD END REMOVAL & REPLACEMENT.

STEP 1

Place piston rod in a hydraulic press using a clean radius or triangle aluminum soft jaw.



STEP 2

Using torch, heat up the rod end where it meets the piston rod. This will loosen the red Loctite and allow for the rod end to spin easier.



It is ok for the shock to be fully assembled, with the exception of springs/seats, when replacing the rod end.

STEP 3

Using an adjustable open end wrench (or similar) rotate the eyelet counter clockwise and remove.



For better leverage, use an open end wrench with a long handle.

STEP 4

To reinstall new rod end, first place a dab of 271 red Loctite in the rod end thread.

STEP 5

Screw new rod end on to piston rod and tighten using an adjustable open end wrench.

CHANGING THE HOSE.



WARNING!

Release gas pressure and complete section Piston Rod Assembly - Removal, page 12-13, before continuing.

STEP 1

Remove piston rod assembly from shock body.
(Refer to the section: Piston Rod Assembly Removal, page 12)

STEP 3

Remove reservoir hose from shock body using 7/8" box wrench.



STEP 5

Replace new hose on reservoir.

STEP 7

Install piston rod into shock body
(Refer to the section: Installing the Piston Rod, page 30)

STEP 2

Drain shock oil.
(Refer to the section: Draining the Oil, page 20)

STEP 4

Remove hose from reservoir end cap using (2) 7/8" box wrenches.



STEP 6

Fill shock with oil.
(Refer to the section: Filling the Oil, page 29)

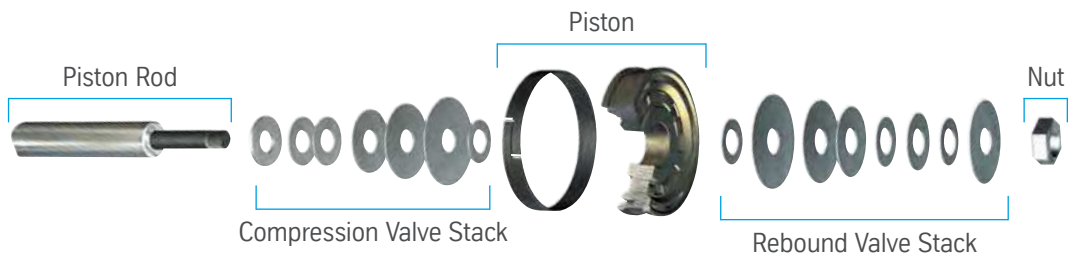
STEP 8

Charge shock with desired nitrogen pressure.
(Refer to the section: Pressurizing the Shock Absorber, page 32)

VALVING CHART.

46mm Valve Stacks						
Rebound						
Rebound / Compression	360/80	275/78	255/100	180/75	170/60	150/50
Brake	20X3.0	20X3.0	20X3.0	20X3.0	20X3.0	20x3.0
Support#4	19X50	18X50	19x50	20X50	20X50	20X50
Support#3	22X40	22X50	22X50	22X25	22X35	22X30
Support#2	28X40	28X40	28X40	28X25	28x40	28x30
Support#1	32X40	32X35	32X30	32X25	32X25	32X25
Cover Disc	37.4X40	37.4X35	37.4X35	37.4X25	37.4X25	37.4X25
Bypass	18X10	18X10	18X10	18x15	18x20	18x10
Piston	U37T PISTON	U37T PISTON	U37T PISTON	U37T PISTON	U37T PISTON	U37T PISTON
Bypass	18X15	18X15	18X10	18X20	18X20	18X10
Cover Disc	37.4X30	37.4X30	37.4X35	37.4X30	37.4X25	35.8x25
Support#1	32X30	32X25	32X30	32X30	32X20	32X20
Support#2	28X30	28X20	28X30	28X30	28X25	28X25
Support#3	22X50	22X50	22X30	22X50	22X35	22X35
Support#4	17X50	17X50	19x50	19X50	18x50	18x50
Support#5	17X50	17X50	19x50	19X50	18x50	18x50
Brake	B46-22	B46-22	B46-22	B46-22	B46-22	B46-22
Compression						

60mm Valve Stacks					
Rebound					
Rebound / Compression	370/110	308/82	275/78	255/70	170/60
Brake	32.5 x 2.5	32.5 x 2.5	32.5 x 2.5	32.5 x 2.5	32.5 x 2.5
Support#4	30x.50	28x.50	28x.50	28x.50	28x.50
Support#3	32x.50	32x.50	32x.35	32x.35	32x.30
Support#2	36x.50	36x.40	36x.35	36x.35	36x.30
Support#1	46.8x.35	42x.40	42x.35	42x.35	42x.30
Cover Disc	46.8x.35	46.8x.40	46.8x.40	46.8x.35	46.8x.30
Bypass	A06 Bleed	A06 Bleed	A06 Bleed	A01 Bleed	A11 Bleed
Preload	32x.35	32x.35	32x.35	32x.35	32x.35
Preload	32x.40	32x.40	32x.40	32x.40	32x.40
Piston	60mm Digressive	60mm Digressive	60mm Digressive	60mm Digressive	60mm Digressive
Preload	32x.40	32x.40	32x.40	32x.40	32x.40
Preload	32x.35	32x.35	32x.35	32x.35	32x.35
Bypass	A04 Bleed	A04 Bleed	A04 Bleed	A07 Bleed	A07 Bleed
Cover Disc	46.8x.35	46.8x.35	46.8x.30	46.8x.30	46.8x.30
Support#1	42x.35	42x.30	42x30	42x30	42x.30
Support#2	36x.35	36x.30	36x.30	36x.30	36x.25
Support#3	30x.35	28x.30	28x.30	28x.30	28x.25
Support#4	24x.35	22x.30	22x.30	22x.30	22x.25
Support#5	18x.50	17x.50	16x.50	15x.50	15x.50
Support#6		17x.50	16x.50	15x.50	15x.50
Brake	37.5x3	37.5x3	37.5x3	37.5x3	37.5x3
Compression					



OIL VOLUME CHART.

Part #	Description	Oil Volume (mL (CC))
B8 8125 - 46mm (2.0") Oil Volumes		
33-225463	46mm Coilover W/ Reservoir, 5" Stroke	374
33-225487	46mm Coilover W/ Reservoir, 6" Stroke	417
33-225500	46mm Coilover W/ Reservoir, 8" Stroke	501
33-225524	46mm Coilover W/ Reservoir, 10" Stroke	586
33-225548	46mm Coilover W/ Reservoir, 12" Stroke	684
33-225562	46mm Coilover W/ Reservoir, 14" Stroke	768
33-225586	46mm Coilover W/ Reservoir, 16" Stroke	852
B8 8125 - 60mm (2.65") Oil Volumes		
33-225456	60mm Coilover W/ Reservoir, 5" Short Body	628
33-225470	60mm Coilover W/ Reservoir, 6" Short Body	700
33-225494	60mm Coilover W/ Reservoir, 8" Short Body	843
33-225517	60mm Coilover W/ Reservoir, 10" Short Body	1023
33-225531	60mm Coilover W/ Reservoir, 12" Short Body	1159
33-225555	60mm Coilover W/ Reservoir, 14" Short Body	1339
33-225593	60mm Coilover W/ Reservoir, 10" Standard Body	1076
33-225616	60mm Coilover W/ Reservoir, 12" Standard Body	1212
33-225630	60mm Coilover W/ Reservoir, 14" Standard Body	1427
33-225654	60mm Coilover W/ Reservoir, 16" Standard Body	1571

PARTS LIST.

Part #	Description	MSRP
Bodies		
E4-R00-Z021A00	Body: 46mm(2.0") Coilover, 8.35" Long, 5" Travel	\$ 95.00
E4-R00-Z021A01	Body: 46mm(2.0") Coilover, 9.35" Long, 6" Travel	\$ 95.00
E4-R00-Z021A02	Body: 46mm(2.0") Coilover, 11.35" Long, 8" Travel	\$ 95.00
E4-R00-Z021A03	Body: 46mm(2.0") Coilover, 13.35" Long, 10" Travel	\$ 95.00
E4-R00-Z021A04	Body: 46mm(2.0") Coilover, 15.85" Long, 12" Travel	\$ 95.00
E4-R00-Z021A05	Body: 46mm(2.0") Coilover, 17.85" Long, 14" Travel	\$ 95.00
E4-R00-Z021A06	Body: 46mm(2.0") Coilover, 19.85" Long, 16" Travel	\$ 95.00
E4-R00-Z022A02	Body: 60mm(2.65") Coilover, 11.80" Long, 8" Travel SB	\$ 110.00
E4-R00-Z022A03	Body: 60mm(2.65") Coilover, 14.30" Long, 10" Travel SB	\$ 110.00
E4-R00-Z022A04	Body: 60mm(2.65") Coilover, 16.30" Long, 12" Travel SB	\$ 110.00
E4-R00-Z022A05	Body: 60mm(2.65") Coilover, 18.80" Long, 14" Travel SB	\$ 110.00
E4-R00-Z022A06	Body: 60mm(2.65") Coilover, 13.30" Long, 8" Travel	\$ 110.00
E4-R00-Z022A07	Body: 60mm(2.65") Coilover, 15.30" Long, 10" Travel	\$ 110.00
E4-R00-Z022A08	Body: 60mm(2.65") Coilover, 17.30" Long, 12" Travel	\$ 110.00
E4-R00-Z022A09	Body: 60mm(2.65") Coilover, 20.30" Long, 14" Travel	\$ 110.00
E4-R00-Z022A10	Body: 60mm(2.65") Coilover, 22.30" Long, 16" Travel	\$ 110.00
Body Caps		
E4-LG0-Z024A00	Body Cap: 46mm(2.0") 1/8-27 NPT Schrader Valve Port	\$ 72.00
E4-LG0-Z024A01	Body Cap: 46mm(2.0") 1/2-14 NPT Reservoir Hose Port	\$ 72.00
E4-LG0-Z025A00	Body Cap: 60mm(2.65") 1/2-14 NPT Reservoir Hose Port	\$ 75.00
Shafts		
E4-KS2-Z065A00	Shaft: .866 DIA. 5" Travel 6.75" Chrome Length	\$ 50.00
E4-KS2-Z065A01	Shaft: .866 DIA. 6" Travel 7.75" Chrome Length	\$ 50.00
E4-KS2-Z065A03	Shaft: .866 DIA. 8" Travel 9.75" Chrome Length	\$ 50.00
E4-KS2-Z065A05	Shaft: .866 DIA. 10" Travel 11.75" Chrome Length	\$ 60.00
E4-KS2-Z065A07	Shaft: .866 DIA. 12" Travel 14.20" Chrome Length	\$ 60.00
E4-KS2-Z065A09	Shaft: .866 DIA. 14" Travel 16.20" Chrome Length	\$ 75.00
E4-KS2-Z065A11	Shaft: .866 DIA. 16" Travel 18.20" Chrome Length	\$ 80.00
Rod Ends		
E4-LG5-Z007A00	Rod End: Standard 2.75" Overall Length	\$ 21.00
E4-LG5-Z007A01	Rod End: Standard +1	\$ 21.00
E4-LG5-Z007A02	Rod End: Standard +2	\$ 24.00
E4-LG5-Z007A03	Rod End: Standard +3	\$ 31.00
E4-LG5-Z007A04	Rod End: Standard +4	\$ 35.00
E4-LG5-Z007A05	Rod End: Standard +5	\$ 39.00
Heims and Heim Spacers		
E4-GL1-Z017A00	(-10) Heim: .625 ID, 1.187 O.D. COM 10TKH PTFE Lined	\$ 45.00
E4-R04-Z016A32	(-10) Heim Spacer: 5/8" TO 1/2" Bolt, 1.50" Tab Width	\$ 5.00
E4-SP1-Z014A01	Retaining Ring: Heim 1.1875	\$ 1.00
Damping Pistons		
E4-B46-Z0SNDT	Piston: 46mm(2.0") Working Piston-Linear	\$ 47.50
E4-AK1-Z050A00	Piston: 60mm(2.65") Working Piston-Digressive	\$ 40.00
Reservoirs and Components		
B4-RV3-Z004A08	Reservoir: Assembly, 60mm(2.65") X 12.00" (Complete)	\$ 145.00
E4-R01-Z134A03	Reservoir Tube: 60mm(2.65") X 12.00"	\$ 50.00
E4-FU0-Z017A02	End Cap: Reservoir, Schrader Port, 60mm(2.65")	\$ 20.00
E4-FU0-Z017A01	End Cap: Reservoir w/ -8 ORB Port, 60mm(2.65")	\$ 20.00
B4-FU0-Z003A00	End Cap: Reservoir w/ Schrader (Complete), 60mm(2.65")	\$ 25.00
B4-FU0-Z002A01	End Cap: Reservoir w/ -8 Fitting (Complete), 60mm(2.65")	\$ 30.00
E4-KR2-X017A00	Wear Band: Reservoir Piston (IFP), 60mm(2.65")	\$ 15.00
B4-TK6-Z003A00	Piston: Internal Floating, 60mm(2.65")	\$ 20.00
B4-RV3-Z005A03	Reservoir: Assembly, 46mm(2.0") x 381mm	\$ 125.00
E4-R03-Z112A00	Reservoir Tube: 46mm(2.0") x 381mm, Zinc Plated	\$ 45.00
E4-FU0-Z020A00	End Cap: Reservoir -8 ORB 46mm(2.0")	\$ 20.00
B4-TK3-Z003A02	Dividing Piston: plastic (F), 46mm(2.0")	\$ 11.00
B4-BOA-0000016	End Cap: ASSY., Schrader (complete), 46mm(2.0")	\$ 26.00
E4-B46-26	Snap Ring: internal, 46mm(2.0")	\$ 0.61
E4-FU0-Z013A01	End Cap: Reservoir 1/8" NPT, 46mm(2.0")	\$ 20.00
E4-DI6-Z026A00	O-Ring: 39.70/3.53, 46mm(2.0")	\$ 1.35
B4-XD0-Z006A01	Valve: 1/8-27 Schrader	\$ 3.45

Part #	Description	MSRP
Reservoirs and Components <i>continued...</i>		
25250129	Cap: Schrader Valve	\$ 1.65
1001025	Adapter: O-Ring Port to -8 Male JIC	\$ 4.50
2021-8-8S	Adapter: 1/2" Pipe to -8 Male JIC	\$ 3.50
Wear Bands		
E4-KR2-X001A02	Wear Band: 46mm(2.0") Working Piston	\$ 2.00
E4-KR2-X017A00	Wear Band: 60mm(2.65") Working Piston	\$ 8.00
Reservoir Hose and Fittings		
B4-XA0-Z005A01	Hose Assembly: -8 JIC ST X JIC ST 12" Long	\$ 30.00
4411-8S	Hose Fitting: Straight	\$ 18.00
190297-8S	Hose Fitting: 45 Degree	\$ 30.00
190296-8S	Hose Fitting: 90 Degree	\$ 30.00
1000600	Hose: Black -8 (sold per mm)	\$ 0.03
Rod Guide Wiper Caps		
E4-SB6-Z091A01	Wiper Cap: 46mm(2.0") .866 (22mm) DIA. Shaft	\$ 15.00
B4-SB2-Z016A00	Wiper Cap: 46mm(2.0") .866 (22mm) DIA. Shaft (Complete w/ Seal)	\$ 20.00
E4-SB6-Z092A01	Wiper Cap: 60mm(2.65") .866 (22mm) DIA. Shaft	\$ 18.00
B4-SB2-Z017A00	Wiper Cap: 60mm(2.65") .866 (22mm) DIA. Shaft (Complete w/ Seal)	\$ 23.00
412CCSS	Screw: M4X12 Socket Head Cap	\$ 1.00
Rod Guides		
E4-FU2-Z046A00	Rod Guide: 46mm(2.0") .866" (22mm) DIA. Shaft	\$ 30.00
E4-FU2-Z047A00	Rod Guide: 60mm(2.65") .866 (22mm) DIA. Shaft	\$ 35.00
B4-VS3-Z008A00	Rod Guide: 46mm(2.0") .866 (22mm) DIA. Shaft Complete w/ Seals and O-Ring	\$ 65.00
B4-VS3-Z009A00	Rod Guide: 60mm(2.65") .866 (22mm) DIA Shaft Complete w/ Seals and O-Ring	\$ 75.00
E4-LB1-Z015A00	Bearing: DU, .866 DIA.(22mm) Shaft	\$ 2.00
O-Rings and Seals		
B4-KT0-Z023A01	Seal Kit: 46mm(2.0") C/O and Smooth Body	\$ 32.40
B4-KT0-Z024A01	Seal Kit: 60mm(2.65") C/O and Smooth Body	\$ 32.40
194432	Shaft Seal: .866" (22mm) DIA. Shaft, Urethane	\$ 4.00
E4-B36-364	Shaft Seal: .866" (22mm) DIA. Shaft, STEP w/ O-Ring	\$ 6.00
194044	Wiper: .866" (22mm) DIA. Shaft, Urethane	\$ 4.00
E4-BOA-0000450	O-Ring: 60mm(2.65") Viton, Reservoir Floating Piston (IFP)	\$ 5.00
E4-DI6-Z026A00	O-Ring: 46mm(2.0") Rod Guide	\$ 1.35
1000406	O-Ring: 60mm(2.65") Rod Guide and Reservoir End Cap	\$ 1.00
Spring Hardware		
E4-FT3-Z049A00	Hat: 46mm(2.0") Lower Spring Retainer, 2.50" ID Spring	\$ 30.00
E4-FT3-Z050A00	Hat: 60mm(2.65") Lower Spring Retainer, 3.00" ID Spring	\$ 45.00
E4-FT4-Z042A00	Seat: 46mm(2.0") Threaded Upper Preload 2.50" ID Spring	\$ 30.00
E4-FT4-Z043A00	Seat: 46mm(2.65") Threaded Upper Preload 3.00" ID Spring	\$ 35.00
E4-FT4-Z044A00	Stop Ring 46mm (2.0") Shock	\$ 12.00
E4-FT4-Z045A00	Stop Ring 60mm (2.65") Shock	\$ 12.00
E4-RO1-Z151A00	Slider: 46mm(2.0") Shock, 2.5" ID Spring	\$ 25.00
E4-RO1-Z152A00	Slider: 60mm(2.65") Shock, 3.0" ID Spring	\$ 30.00
Miscellaneous Hardware		
E4-MU1-Z015A00	Nut: 12 X 1.00mm Piston	\$ 1.00
E4-B46-26	Retaining Ring: 46mm(2.0") Internal	\$ 0.61
E4-BOA-0000130	Retaining Ring: 60mm(2.65") Internal	\$ 1.00
5264051	Hose CLAMP: #56 STAINLESS	\$ 2.00
9244B	Mount: Urethane, Reservoir	\$ 5.00
E4-RO3-Z111A01	Internal Spacer: .400 Long	\$ 6.00
E4-AP2-Z133A00	Bump Stop: Shaft 46mm(2.0") Shock	\$ 6.50
E4-AP2-Z075A03	Bump Stop: Shaft 60mm(2.65") Shock	\$ 6.50
Oil		
194131	Oil: Gallon BILSTEIN High Temp Race	\$ 33.00
Reservoir Mount Kit		
B4-KT1-Z315A00	Reservoir Mount Kit: 46mm(2.0")	\$ 10.00
B4-KT1-Z292ZA00	Reservoir Mount Kit: 60mm(2.65")	\$ 10.00
Reservoir Sticker		
E4-WM1-Z233A00	Reservoir Sticker: 46mm(2.0")	\$ 4.50
E4-WM1-Z233A01	Reservoir Sticker: 60mm(2.65")	\$ 4.50
Valving Kit		
B4-BOA-0001224	Valve Disc Kit: 46mm/60mm/70mm	\$ 295.00

Part #	Description	MSRP
Valve Discs		
E4-FE1-Z009A76	Disc, 12 ID, 15.5/50	\$ 1.45
E4-FE1-Z009A02	Disc, 12 ID, 15/50	\$ 1.45
E4-FE1-Z009A73	Disc, 12 ID, 16.5/50	\$ 1.45
E4-FE1-Z009A43	Disc, 12 ID, 16/50	\$ 1.45
E4-FE1-Z009A72	Disc, 12 ID, 17.5/50	\$ 1.45
E4-FE1-Z009A44	Disc, 12 ID, 17/50	\$ 1.45
E4-FE1-Z009A74	Disc, 12 ID, 18.5/50	\$ 1.45
E4-FE1-Z009A00	Disc, 12 ID, 18/10	\$ 1.45
E4-FE1-Z009A01	Disc, 12 ID, 18/15	\$ 1.45
E4-FE1-Z009A06	Disc, 12 ID, 18/20	\$ 1.45
E4-FE1-Z009A97	Disc, 12 ID, 18/25	\$ 1.45
E4-FE1-Z009A10	Disc, 12 ID, 18/30	\$ 1.45
E4-FE1-Z009A08	Disc, 12 ID, 18/35	\$ 1.45
E4-FE1-Z009A09	Disc, 12 ID, 18/40	\$ 1.45
E4-FE1-Z009A07	Disc, 12 ID, 18/45	\$ 1.45
E4-FE1-Z009A46	Disc, 12 ID, 18/50	\$ 1.45
E4-FE1-Z009B41	Disc, 12 ID, 19.5/50	\$ 1.45
E4-FE1-Z009A49	Disc, 12 ID, 19/50	\$ 1.45
E4-FE1-Z009A04	Disc, 12 ID, 20/10	\$ 1.45
E4-FE1-Z009A05	Disc, 12 ID, 20/15	\$ 1.45
E4-FE1-Z009A03	Disc, 12 ID, 20/20	\$ 1.45
E4-FE1-Z009A39	Disc, 12 ID, 20/25	\$ 1.45
E4-FE1-Z009A50	Disc, 12 ID, 20/30	\$ 1.45
E4-FE1-Z009A40	Disc, 12 ID, 20/35	\$ 1.45
E4-FE1-Z009A32	Disc, 12 ID, 20/40	\$ 1.45
E4-FE1-Z009A51	Disc, 12 ID, 20/45	\$ 1.45
E4-FE1-Z009A34	Disc, 12 ID, 20/50	\$ 1.45
E4-FE1-Z009A98	Disc, 12 ID, 20/60	\$ 1.45
E4-FE1-Z009A82	Disc, 12 ID, 22/25	\$ 1.45
E4-FE1-Z009A11	Disc, 12 ID, 22/30	\$ 1.45
E4-FE1-Z009A38	Disc, 12 ID, 22/35	\$ 1.45
E4-FE1-Z009A47	Disc, 12 ID, 22/50	\$ 1.45
E4-FE1-Z009A52	Disc, 12 ID, 24/15	\$ 1.45
E4-FE1-Z009A53	Disc, 12 ID, 24/20	\$ 1.45
E4-FE1-Z009A54	Disc, 12 ID, 24/25	\$ 1.45
E4-FE1-Z009A41	Disc, 12 ID, 24/30	\$ 1.45
E4-FE1-Z009A55	Disc, 12 ID, 24/35	\$ 1.45
E4-FE1-Z009A33	Disc, 12 ID, 24/40	\$ 1.45
E4-FE1-Z009A56	Disc, 12 ID, 24/45	\$ 1.45
E4-FE1-Z009A35	Disc, 12 ID, 24/50	\$ 1.45
E4-FE1-Z009A15	Disc, 12 ID, 24/60	\$ 1.45
E4-FE1-Z009A17	Disc, 12 ID, 26/35	\$ 1.45
E4-FE1-Z009A36	Disc, 12 ID, 26/50	\$ 1.45
E4-FE1-Z009A18	Disc, 12 ID, 28/10	\$ 1.45
E4-FE1-Z009B00	Disc, 12 ID, 28/20	\$ 1.45
E4-FE1-Z009A19	Disc, 12 ID, 28/25	\$ 1.45
E4-FE1-Z009A20	Disc, 12 ID, 28/30	\$ 1.45
E4-FE1-Z009A21	Disc, 12 ID, 28/35	\$ 1.45
E4-FE1-Z009A22	Disc, 12 ID, 28/40	\$ 1.45
E4-FE1-Z009A85	Disc, 12 ID, 28/45	\$ 1.45
E4-FE1-Z009A23	Disc, 12 ID, 28/50	\$ 1.45
E4-FE1-Z009A25	Disc, 12 ID, 28/60	\$ 1.45
E4-FE1-Z009A42	Disc, 12 ID, 30/25	\$ 1.45
E4-FE1-Z009A86	Disc, 12 ID, 30/30	\$ 1.45
E4-FE1-Z009A57	Disc, 12 ID, 30/35	\$ 1.45
E4-FE1-Z009A87	Disc, 12 ID, 30/45	\$ 1.45
E4-FE1-Z009A30	Disc, 12 ID, 30/50	\$ 1.45
E4-FE1-Z009A48	Disc, 12 ID, 32/20	\$ 1.45
E4-FE1-Z009A28	Disc, 12 ID, 32/25	\$ 1.45
E4-FE1-Z009A31	Disc, 12 ID, 32/30	\$ 1.45

Part #	Description	MSRP
Valve Discs <i>continued...</i>		
E4-FE1-Z009A29	Disc, 12 ID, 32/35	\$ 1.45
E4-FE1-Z009A45	Disc, 12 ID, 32/40	\$ 1.45
E4-FE1-Z009A90	Disc, 12 ID, 32/45	\$ 1.45
E4-FE1-Z009A27	Disc, 12 ID, 32/50	\$ 1.45
E4-FE1-Z009A24	Disc, 12 ID, 35.8/35	\$ 1.45
E4-FE1-Z009B14	Disc, 12 ID, 35.8/40	\$ 1.45
E4-FE1-Z009B20	Disc, 12 ID, 35.8/45	\$ 1.45
E4-FE1-Z009A94	Disc, 12 ID, 35/25	\$ 1.45
E4-FE1-Z009A58	Disc, 12 ID, 35/30	\$ 1.45
E4-FE1-Z009A59	Disc, 12 ID, 35/35	\$ 1.45
E4-FE1-Z009A92	Disc, 12 ID, 35/45	\$ 1.45
E4-FE1-Z009A95	Disc, 12 ID, 35/60	\$ 1.45
E4-FE1-Z009B01	Disc, 12 ID, 36.4/25	\$ 1.45
E4-FE1-Z009B02	Disc, 12 ID, 36.4/35	\$ 1.45
E4-FE1-Z009A60	Disc, 12 ID, 36/20	\$ 1.45
E4-FE1-Z009A61	Disc, 12 ID, 36/25	\$ 1.45
E4-FE1-Z009A63	Disc, 12 ID, 36/30	\$ 1.45
E4-FE1-Z009A64	Disc, 12 ID, 36/35	\$ 1.45
E4-FE1-Z009A65	Disc, 12 ID, 36/40	\$ 1.45
E4-FE1-Z009A66	Disc, 12 ID, 36/45	\$ 1.45
E4-FE1-Z009A67	Disc, 12 ID, 36/50	\$ 1.45
E4-FE1-Z009A68	Disc, 12 ID, 36/60	\$ 1.45
E4-FE1-Z009A75	Disc, 12 ID, 36/70	\$ 1.45
E4-FE1-Z009A69	Disc, 12 ID, 36/80	\$ 1.45
E4-FE1-Z009B05	Disc, 12 ID, 37.4/25	\$ 1.45
E4-FE1-Z009B06	Disc, 12 ID, 37.4/30	\$ 1.45
E4-FE1-Z009B11	Disc, 12 ID, 37.4/35	\$ 1.45
E4-FE1-Z009B24	Disc, 12 ID, 37.4/40	\$ 1.45
E4-FE1-Z009B10	Disc, 12 ID, 37.4/45	\$ 1.45
E4-FE1-Z009A78	Disc, 12 ID, 40/80	\$ 1.45
E4-FE1-Z009B60	Disc, 12 ID, 42/25	\$ 1.45
E4-FE1-Z009B61	Disc, 12 ID, 42/35	\$ 1.45
E4-FE1-Z009B62	Disc, 12 ID, 42/40	\$ 1.45
E4-FE1-Z009B63	Disc, 12 ID, 42/45	\$ 1.45
E4-FE1-Z009B64	Disc, 12 ID, 42/50	\$ 1.45
E4-FE1-Z009B66	Disc, 12 ID, 44/25	\$ 1.45
E4-FE1-Z009B67	Disc, 12 ID, 44/35	\$ 1.45
E4-FE1-Z009B70	Disc, 12 ID, 44/45	\$ 1.45
E4-FE1-Z009B71	Disc, 12 ID, 44/50	\$ 1.45
E4-FE1-Z009B72	Disc, 12 ID, 44/60	\$ 1.45
E4-FE1-Z009B73	Disc, 12 ID, 46.8/25	\$ 1.45
E4-FE1-Z009B95	Disc, 12 ID, 46.8/30	\$ 1.45
E4-FE1-Z009B74	Disc, 12 ID, 46.8/35	\$ 1.45
E4-FE1-Z009B75	Disc, 12 ID, 46.8/40	\$ 1.45
E4-FE1-Z009B76	Disc, 12 ID, 46.8/45	\$ 1.45
E4-FE1-Z009B77	Disc, 12 ID, 46.8/50	\$ 1.45
E4-FE1-Z009B78	Disc, 12 ID, 46.8/60	\$ 1.45
Bypass Discs		
E4-FE2-Z164A00	Bypass Disc, 46.8 X 0.15, A = 1.5 Bypass	\$ 1.45
E4-FE2-Z164A03	Bypass Disc, 46.8 X 0.15, A = 3.0 Bypass	\$ 1.45
E4-FE2-Z164A06	Bypass Disc, 46.8 X 0.15, A = 4.5 Bypass	\$ 1.45
E4-FE2-Z164A09	Bypass Disc, 46.8 X 0.15, A = 6.0 Bypass	\$ 1.45
E4-FE2-Z164A01	Bypass Disc, 46.8 X 0.20, A = 2.0 Bypass	\$ 1.45
E4-FE2-Z164A04	Bypass Disc, 46.8 X 0.20, A = 4.0 Bypass	\$ 1.45
E4-FE2-Z164A07	Bypass Disc, 46.8 X 0.20, A = 6.0 Bypass	\$ 1.45
E4-FE2-Z164A10	Bypass Disc, 46.8 X 0.20, A = 8.0 Bypass	\$ 1.45
E4-FE2-Z164A11	Bypass Disc, 46.8 X 0.25, A = 10.0 Bypass	\$ 1.45
E4-FE2-Z164A02	Bypass Disc, 46.8 X 0.25, A = 2.5 Bypass	\$ 1.45
E4-FE2-Z164A05	Bypass Disc, 46.8 X 0.25, A = 5.0 Bypass	\$ 1.45
E4-FE2-Z164A08	Bypass Disc, 46.8 X 0.25, A = 7.5 Bypass	\$ 1.45

VALVING TRACKING WORKSHEET.

46mm Valve Stacks						
Rebound						
Rebound / Compression						
Brake						
Support#6						
Support#5						
Support#4						
Support#3						
Support#2						
Support#1						
Cover Disc						
Bypass						
Piston						
Bypass						
Cover Disc						
Support#1						
Support#2						
Support#3						
Support#4						
Support#5						
Support#6						
Brake						
Compression						

60mm Valve Stacks						
Rebound						
Rebound / Compression						
Brake						
Support#6						
Support#5						
Support#4						
Support#3						
Support#2						
Support#1						
Cover Disc						
Bypass						
Preload						
Preload						
Piston						
Preload						
Preload						
Bypass						
Cover Disc						
Support#1						
Support#2						
Support#3						
Support#4						
Support#5						
Support#6						
Brake						
Compression						

BILSTEIN Off-Road Racing Department

14102 Stowe Drive | Poway, CA 92064

(800) 537-1085



thyssenkrupp Bilstein of America

marketing@bilsteinUS.com

www.bilsteinUS.com

Printed in the USA

©2015

4.2016 / Subject to technical modifications. Misprints and errors excepted.