



INSTALLATION GUIDE: AWE EXHAUST FOR THE 3RD GEN TOYOTA TACOMA

For up-to-date fitment information, please visit the product page on [AWE-Tuning.com](https://www.awe-tuning.com).

THIS GUIDE IS INTENDED FOR THE FOLLOWING PART NUMBERS:

3015-33826 AWE 0FG Exhaust with BashGuard for 3rd Gen Tacoma - Dual Diamond Black Tips

3015-32826 AWE 0FG Exhaust with BashGuard for 3rd Gen Tacoma - Dual Chrome Silver Tips

Welcome to the AWE family, and congratulations on your purchase of the AWE Exhaust System for the 3rd Gen Toyota Tacoma

Exquisite build quality and craftsmanship, coupled with industry leading performance, distinguish this exhaust system from all others.

*For up to the minute fitment information, be sure to visit the AWE website. As always, AWE Performance Specialists are standing by for any questions, [right here](#).

PARTS LIST (OFG DUAL SIDE EXIT EXHAUST)



Inspect **ALL** parts prior to disassembly of vehicle; If damaged or **MISSING**, please contact the place of purchase immediately.

Symbol	Part Number	Description	QTY
	E78	Toyota Tacoma 3rd Gen Inlet Driver	1
	E79	Toyota Tacoma 3rd Gen Inlet Passenger	1
	E80	Toyota Tacoma 3rd Gen H Pipe	1
	E81	Toyota Tacoma 3rd Gen Mid Muffler Section	1
	E82	Toyota Tacoma 3rd Gen HR1 Section	2
	E83	Toyota Tacoma 3rd Gen Overaxle Tube Driver	1
	E84	Toyota Tacoma 3rd Gen Overaxle Tube Passenger	1
	E85	Toyota Tacoma 3rd Gen Twin Tailpipe Section	1
	E86	Toyota Tacoma 3rd Gen LWB Adapter Driver/Passenger	2
	E87	Toyota Tacoma 3rd Gen Bash Guard	2
A >>	180250	AWE Band Clamp: 2.5"	12
B >>	3910-41010	Hardware Kit for Integrated Clamp Style Exhaust Tips - Quad	1
C >>	95735A661	Steel Flanged Hex Head Screw, M10 x 1.25mm Thread, 60mm	2
D >>	180014	Chrome Silver Tip	2
	180015	Diamond Black Tip	2

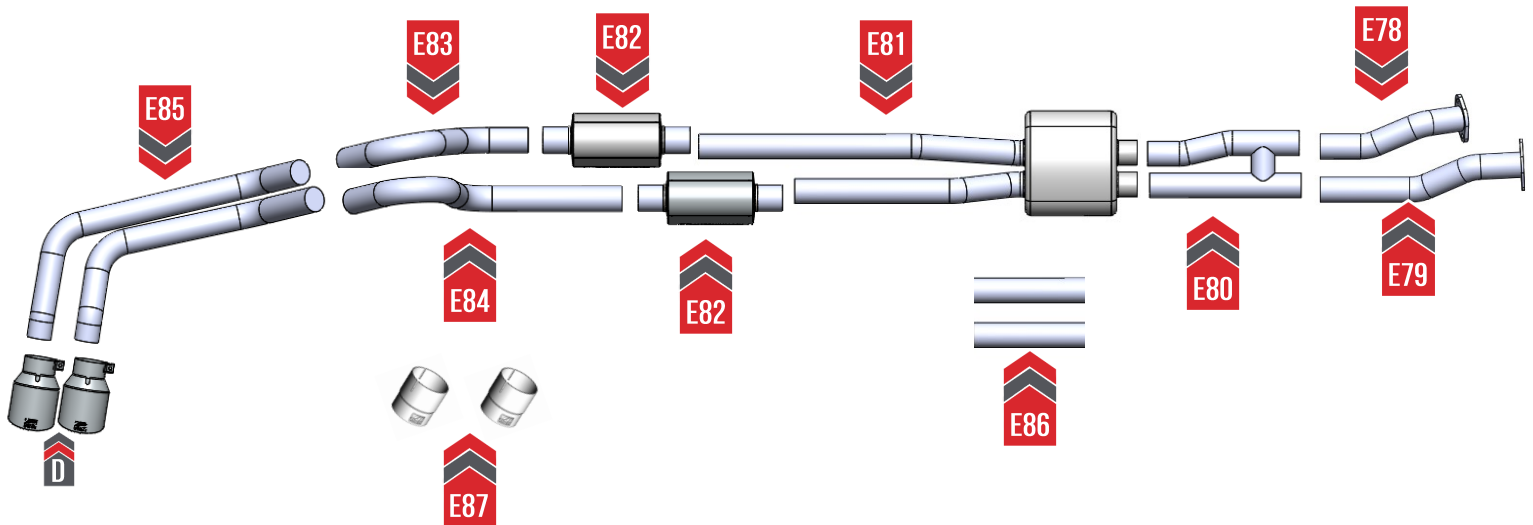



NOTE: Always refer to the manufacturer's service manual for precise torque specifications on all OEM fasteners.



CAUTION: The exhaust may be **VERY HOT** — allow adequate time for the system to cool down before disassembly. Severe burns and injury will occur if skin comes into contact with a hot exhaust system.

STEP 1



Soak all bolts, and rubber hangers in penetrating oil before starting any work.

1. To begin, remove the OE hardware located at **(A)** and **(B)**. The hardware removed from point **(B)** will be re-used.
2. Remove the OE hanger bar from the rubber hanger shown at **(C)**.
3. Remove the OE hardware located at **(D)**. This will allow you to remove the OE y-pipe. Set the OE gaskets aside as they will be re-used.
4. Lastly, remove the hanger bars from the four OE rubber hangers, shown at **(E)**, to remove the OE muffler and tailpipe from the cavity.

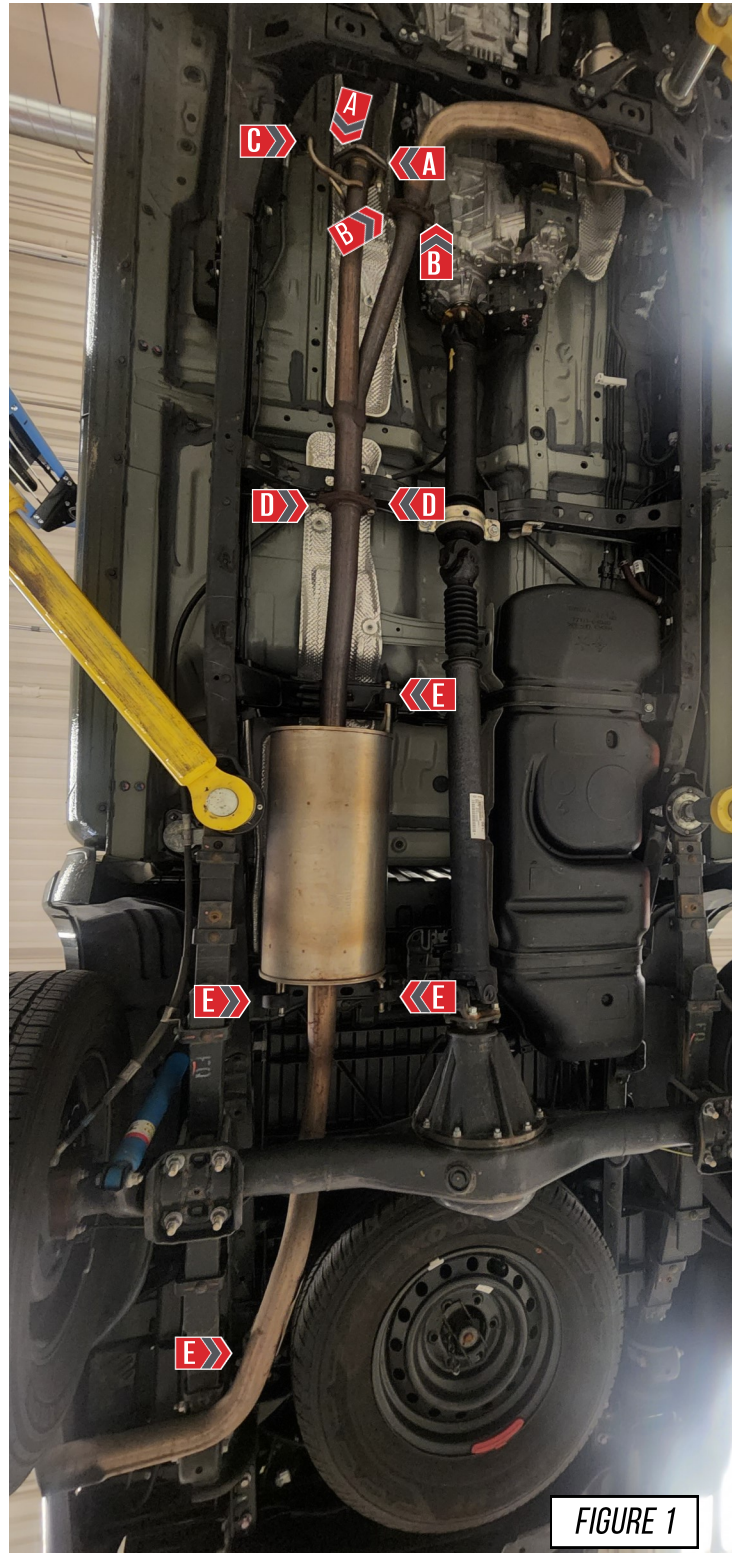

FIGURE 1

STEP 2

After removal of the Y-pipe, reinstall the OE crush gasket (A) and the OE donut gasket (B) shown in **Figure 2**.



Note: If either OE gasket is in poor condition contact the dealer for a replacement.

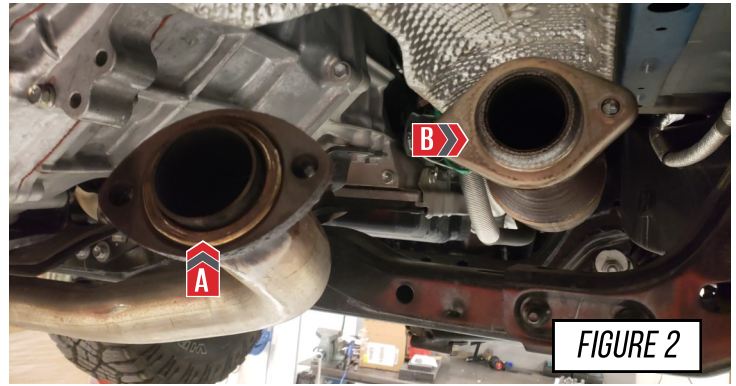

STEP 3

Install your AWE driver side inlet tube (E78) re-using the OE hardware, as shown in **Figure 3**.

Carefully tighten down the 2 bolts evenly, leaving the tube just snug for now.

Note: Uneven pressure on each side can cause the gasket to leak.

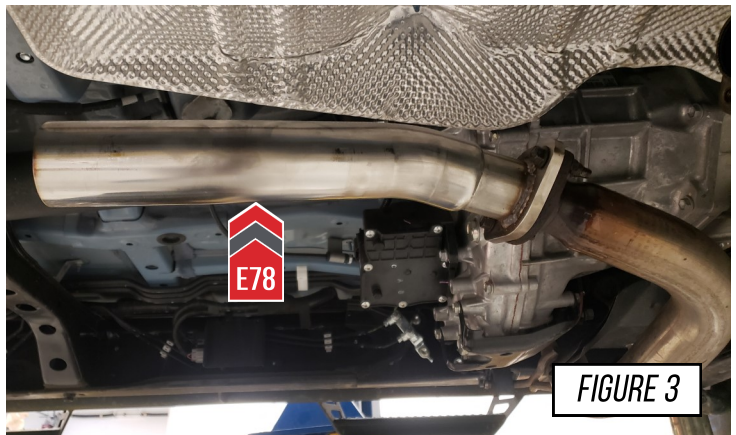

STEP 4

Install your AWE passenger side inlet tube (E79) using the provided hardware, as shown in **Figure 4**. Slide the hanger bar into the OE rubber hanger before installing the provided flange bolts.

Carefully tighten down the 2 bolts evenly, leaving the tube just snug for now.

Note: The OE springs will not be re-used.

Note: Uneven pressure on each side can cause the gasket to break.

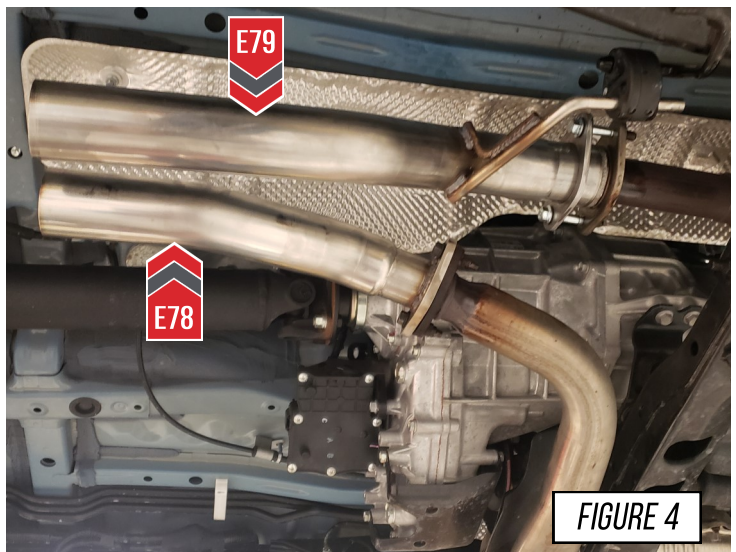

STEP 5

The orientation of the H-pipe is very important for install. The wider end will be at the front of the vehicle and the flat side will sit closer to the passenger side frame rail.



STEP 6

To install the AWE H-pipe slide two provided clamps over each front side outlet of the H-pipe. Bottom out the slip fits on the front pipes and set the H-pipe so it sits level in the vehicle. Once the H-pipe is sitting level, snug the clamps on the slip fit, but do not fully tighten at this time.

With the H-pipe in place and the clamps snug, go back and fully tighten the driver side (A) and passenger side (B) front pipe flanges.

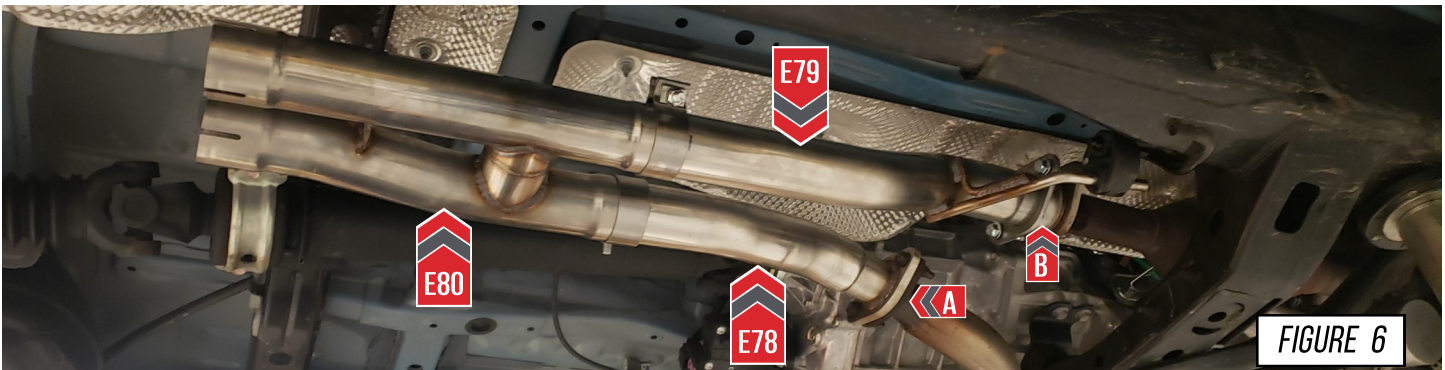

STEP 7



STEP 7 IS FOR LONG WHEEL BASE VEHICLES ONLY



Install your AWE Long Wheel Base Adapters (E86) on to the AWE H-pipe (E80), as shown in **Figure 7**. Slide two of the provided clamps onto the slip fits and bottom out the adapters in the rear side of the H-pipe. Fully tighten the clamps down on the slip fit joint.

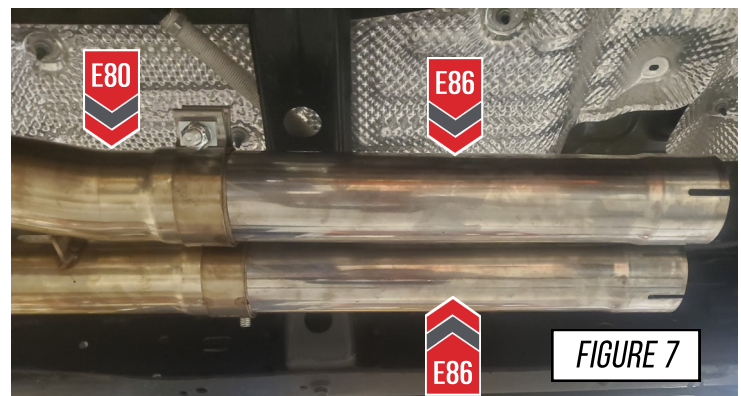

STEP 8

Install your AWE mid muffler section (**E81**), as shown in **Figure 8**. Slide a provided clamp over the expanded rear side of the H-pipes. Bottom out the mid muffler section in the slip fits and snug the clamps over the slip fits, but do not fully tighten at this time.

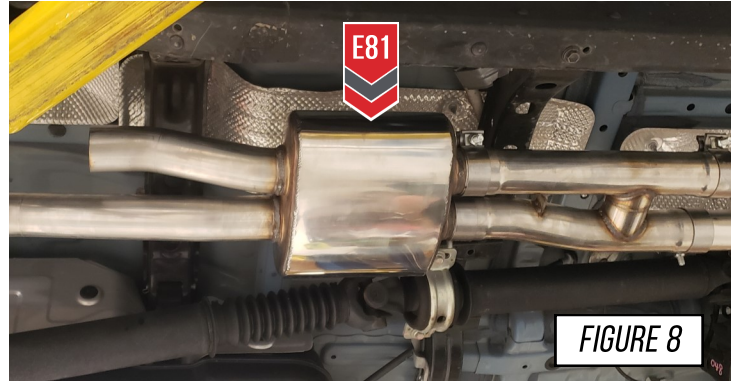

STEP 9

Install your passenger side AWE HR1 section (**E82**), as shown in **Figure 9**. Slide a provided clamp over the expanded end of the HR1 section, position the can straight up and down in the cavity, and snug the clamp down on the slip fit.

Note: When installing your HR1 cans, ensure the drain hole is positioned to the rear of the vehicle and pointing down, as shown at **(A)** in **Figure 9**.

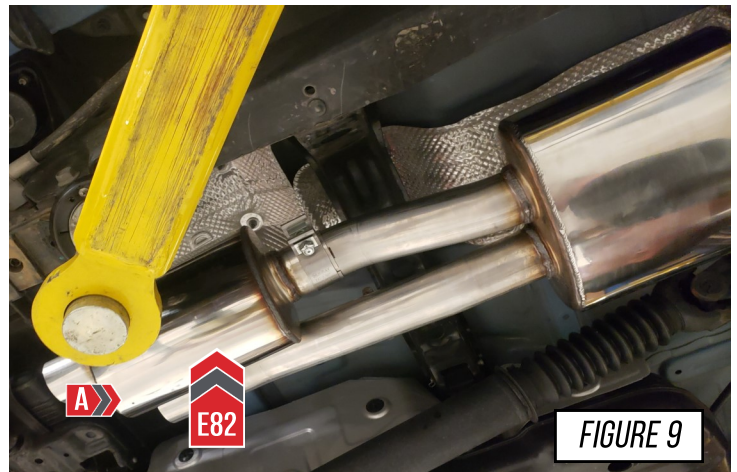

STEP 10

Install your driver side AWE HR1 section (**E82**), as shown in **Figure 10**. Slide a provided clamp over the expanded end of the HR1 section, position the can straight up and down in the cavity, and snug the clamp down on the slip fit.

Note: When installing your HR1 cans ensure the drain hole is positioned to the rear of the vehicle and pointing down, as shown at **(A)** in **Figure 10**.



STEP 11

When you finish installing your HR mufflers, ensure that the drain holes are pointed down and to the rear of the vehicle, as shown in **Figure 11**. Verify that the faces of the mufflers are not touching each other.

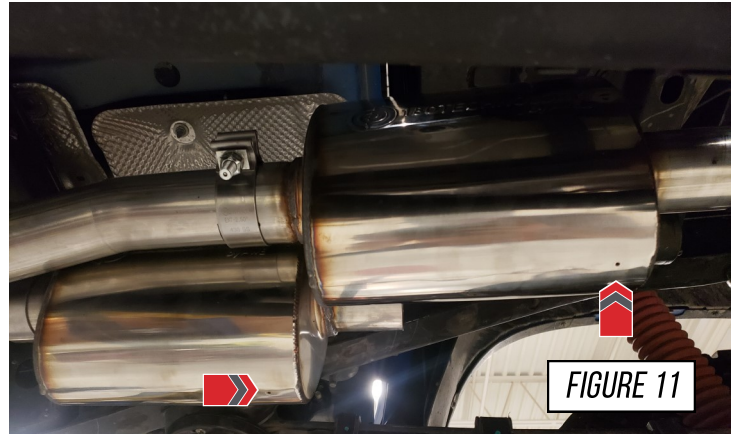

STEP 12

Install your AWE driver side overaxle tube (**E83**), as shown in **Figure 12**. Slide a provided clamp over the slip fit. Insert the hanger bar into the OE rubber hanger, as shown at **(A)**. Bottom out the slip fit on the HR muffler outlet and snug the clamp to hold the tube in place, but do not fully tighten it at this time.



STEP 13

Install your AWE passenger side overaxle tube (**E84**), as shown in **Figure 13**. Slide a provided clamp over the slip fit. Insert the hanger bar into the OE rubber hanger, as shown at **(A)**. Bottom out the slip fit on the HR muffler outlet and snug the clamp to hold the tube in place, but do not fully tighten it at this time.

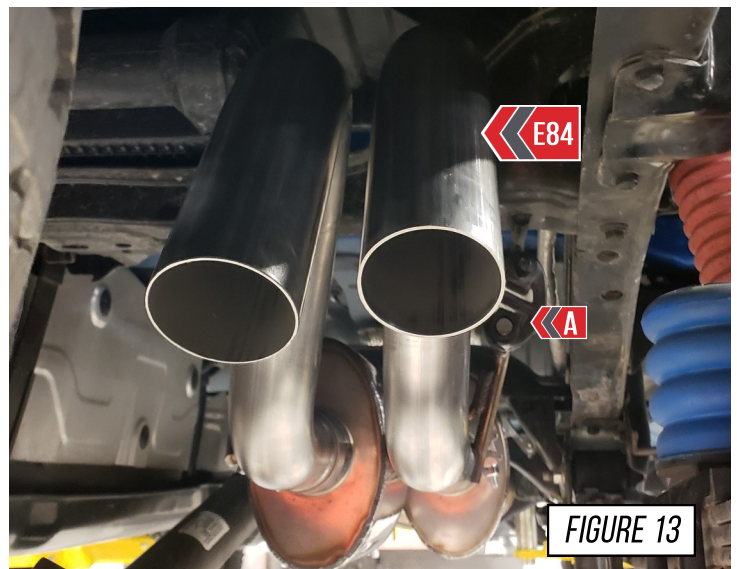

STEP 14

It is crucial to install each section and exhaust band clamps correctly to prevent loose joints, exhaust leaks and rattles.

Arrow A shows the expanded pipe and the preinstalled exhaust clamp being brought up to the corresponding pipe.

Arrow B shows the overlapping pipe installed correctly over the corresponding pipe.

Arrow C shows the exhaust band clamp being brought to the edge of the expanded pipe.



NOTES:

- **Do not** fully torque any exhaust clamp until the entire exhaust has been installed and adjusted.
- Torque specification is a **minimum** of 60 ft/lbs

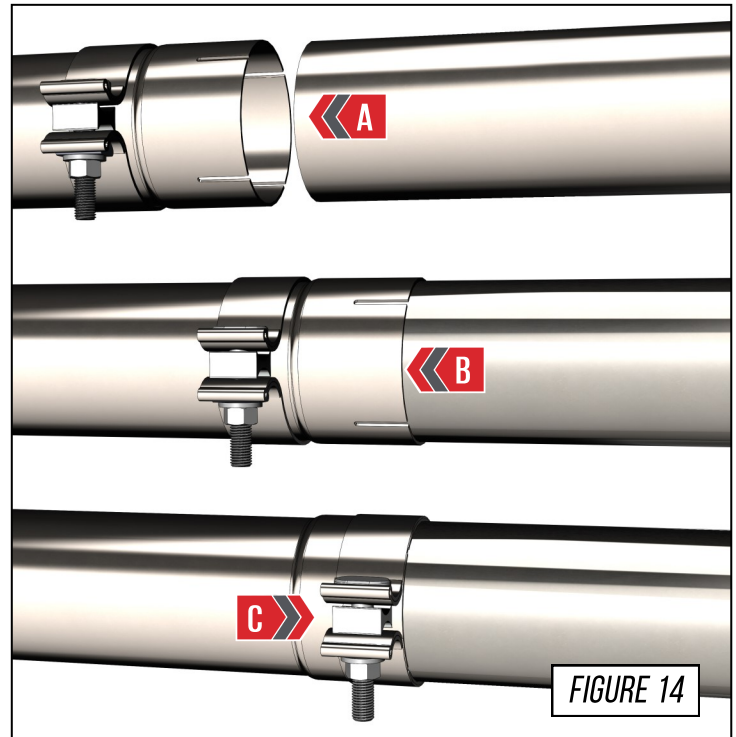

STEP 15



IF YOU DO NOT WISH TO INSTALL THE BASH GUARDS SKIP TO STEP 16.



If you wish to install your AWE Bash Guards, begin by bottoming out the slip fits on the over axle tube and tightening the clamps.

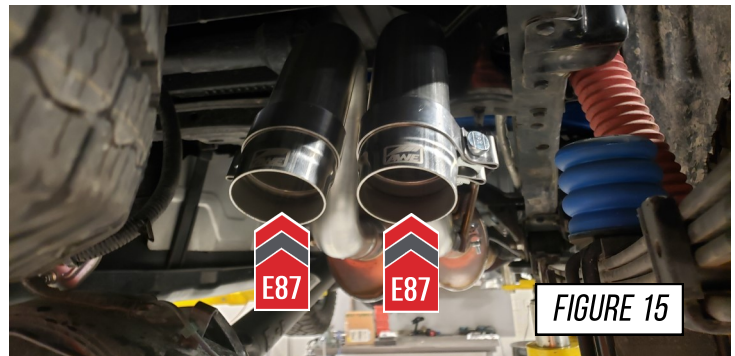

STEP 16

To install your AWE twin tailpipe section (**E85**), slide the hanger bar into the OE hanger, as shown at (**A**). Next slide a provided clamp over the slip fit and bottom out the slip fits on the AWE overaxle tubes (**E83** and **E84**). Snug the clamps at this time but do not fully tighten.



STEP 17

Install your AWE tips using the provided hardware. In this step it will be very helpful to have a friend help to set the tips in place for final adjustments. Most of the adjustments will be made on the AWE twin tailpipe section (**E85**). Once you have the tips positioned to your liking, tighten down the tip hardware.



FIGURE 17

STEP 18

To install the exhaust tips with integrated clamps, first, attach the exhaust tip in the proper orientation onto the exhaust outlet tube.

Insert one of the carriage bolts from the hardware kit (**3910-41010**) through the tab on the exhaust tip and thread on one of the corresponding nuts.

Using anti-seize on the bolt threads will help installation and prevent breakage of hardware.

 If exhaust system only has 2 exhaust tips while the integrated clamp kit has enough hardware for our 4 tip exhaust systems. You will have 2 sets of hardware left over that will not be used.

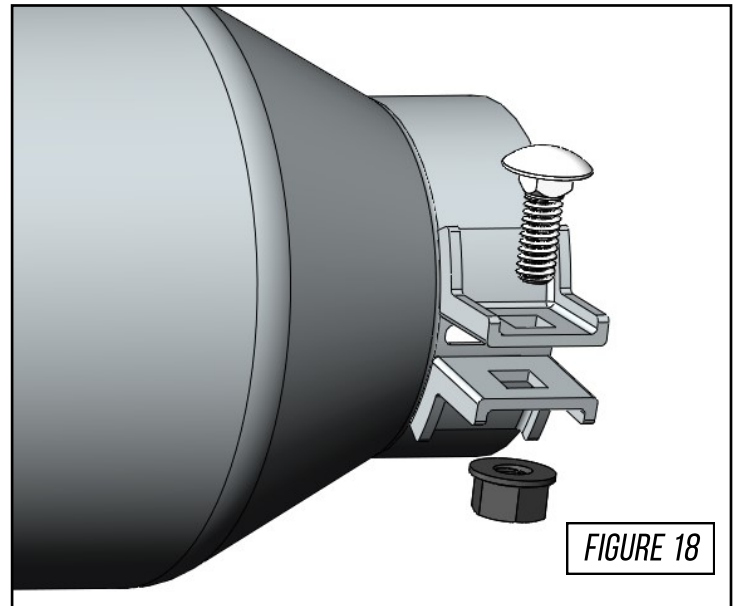

FIGURE 18

STEP 19

Make your final adjustments to the tips and ensure they are in a position you like. Once your desired positioning is achieved, work from the front of the car to the back, tightening all the clamps fully and ensuring there is proper clearance from the frame rails and suspension components.

It is recommended to drive the car to allow the exhaust to heat cycle after all clamps and tips are fully tightened.



At this point the exhaust will be **very hot**, allow to cool before work continues.

Check the tips for correct alignment, adjust as needed.



Don't forget to see the next page for any troubleshooting needs!



FIGURE 19

TROUBLESHOOTING

Issue	Solution
Exhaust is not fitting correctly	Most fitment issues are due to improperly adjusted exhaust. This includes tip fitments and rattling due to chassis contact. Check out our fitment guide for more installation tips.
Incorrect or missing parts	Double check the parts list for your system and compare them with what you received. Fill out our contact form, found below and let us know what parts you need.

CARE

Once installed properly, your AWE exhaust will provide years of trouble-free performance.

The exhaust volume and sound will settle with usage; 800-1000 miles is required to break-in new exhaust systems.

Also, please note that the rear **180Technology**® resonator has a small drain hole to allow condensation to escape. Water drops from this area are normal.

Periodic cleaning of exhaust tips is necessary to maintain proper finish, especially in areas prone to road salt and caustic deicing solutions. Use a mild soap and water solution or car wax to clean the finish. Avoid using abrasive polishes, as they can scratch the finish.

Any questions or comments,
please do not hesitate to contact us:

AWE
215-658-1670
[CONTACT FORM](#)

WARRANTY

Up-to-date warranty information is found [HERE](#).