



## Ventvisor® Deflector

**For proper installation and best possible fit, please read all instructions BEFORE you begin.  
For technical assistance or to obtain missing parts, please call Customer Relations at 1-800-241-7219.**

### Important Safety Information



- CAUTION - Before driving, ensure that the vent visor is properly secured to vehicle.
- Do not use automatic "brush-style" car washes.
- Do not use cleaning solvents of any kind.
- Periodically check all components for tightness.

### Contents - 2 Piece Set **NOTE:** Actual product may vary from illustration.



Front Driver Side Visor



Front Passenger Side Visor



Alcohol Pad x2

### Contents - 4 Piece Set



Front Driver Side Visor



Front Passenger Side Visor



Rear Driver Side Visor



Rear Passenger Side Visor



Alcohol Pad x4

### Tools Required



Car Wash Supplies



Clean Towel

### Preparation Before Painting / Installation

- A trial fit is recommended to ensure proper positioning and fit.
- Check fit of parts before painting as we will not accept the return of modified or painted parts.
- Wash and dry your vehicle to remove any debris and/or dirt from the installation area.

### Installation Steps **NOTE:** Actual application may vary slightly from illustrations.



Clean the window channel with an alcohol pad.

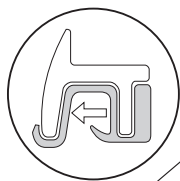

1

Remove tape liner from front flange. Peel back 2" of tape line from each end of top flange.

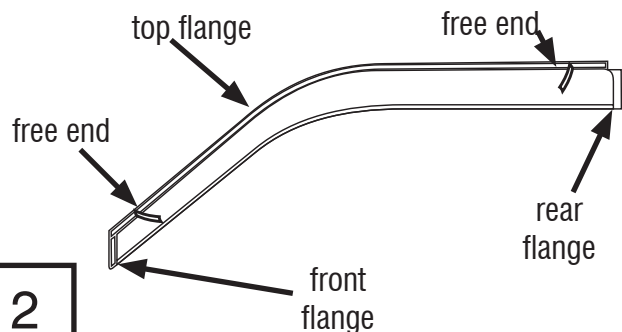

2

## Installation Steps

**NOTE:** Actual application may vary slightly from illustrations.

Insert visor into window channel, rear flange first. Rear flange inserts between the trim and the exterior surface. The front & top flange slides into the window channel.

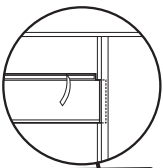

3

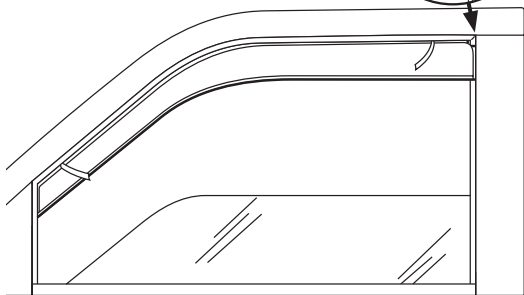

Remove tape liner by pulling on free ends. Raise window slowly and leave up for 24 hours to secure visor to window channel.

4

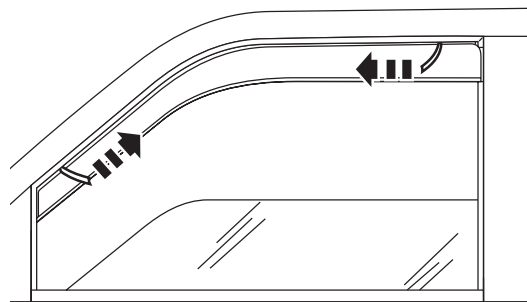

## 4 Piece Set

Install the rear visor using the same preparation and installation methods as front visor. Note that the top & rear flanges slide into the window channel, and the front flange fits between the rubber & window frame.

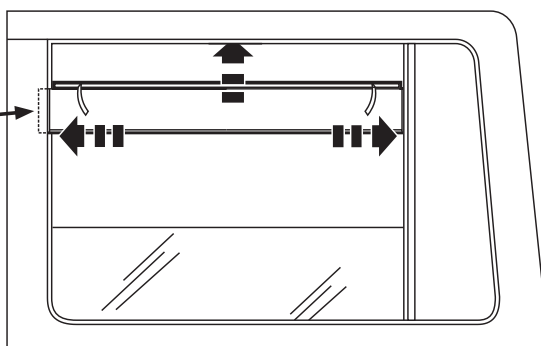
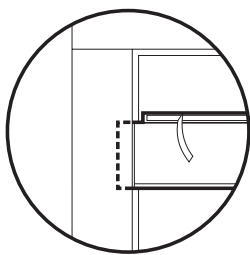

5

Repeat **steps 1 thru 5** for remaining visors

## Care and Cleaning

- Wash only with mild soap & dry with a clean cloth.

## Congratulations!

You have purchased one of the many quality Auto Ventshade™ branded products offered by Lund International, Inc. We take the utmost pride in our products and want you to enjoy years of satisfaction from your investment. We have made every effort to ensure that your product is top quality in terms of fit, durability, finish and ease of installation.



**AUTO VENTSHADE™**

Lund International, Ventshade Accessories Division

655 Raco Drive, Lawrenceville, GA 30045

800-241-7219 • Fax 770-339-5839 • Visit us at [lundinternational.com](http://lundinternational.com)



© 2005 Lund International, Inc. All rights reserved.  
Auto Ventshade™, the Auto Ventshade™ logo and the AVS™ logo are trademarks of Lund International, Inc.





## Ventvisor® Deflector

Pour obtenir une installation correcte et le meilleur ajustement possible, lire toutes les instructions AVANT de commencer.  
 Pour toute assistance technique ou obtention de pièces manquantes, appeler le service des relations avec la clientèle au 1-800-241-7219.

### Informations importantes concernant la sécurité



- ATTENTION – Avant de conduire, s'assurer que la visière est solidement assujettie sur le véhicule.
- Ne pas utiliser les stations de lavage de voitures à brosses.
- Ne pas utiliser de solvants.
- Vérifier régulièrement le serrage des composants.

### Contenu - Ensemble 2 pièces

**NOTE:** Le produit réel peut changer de l'illustration.

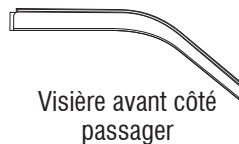

Tampons à l'alcool (2)

### Contenu - Ensemble 4 pièces

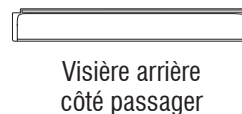
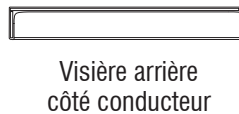

Tampons à l'alcool (4)

### Outils nécessaires



Fournitures pour lavage de voiture



Serviette propre

### Préparation pour la peinture/l'installation

- Il est recommandé de procéder à un essai pour s'assurer que le positionnement et l'ajustement sont corrects.
- Vérifier l'ajustement des pièces avant peinture, car nous n'acceptons pas le retour de pièces modifiées ou peintes.
- Laver les glissières de glaces de la portière du véhicule pour éliminer toute poussière et tous débris.
- Sécher les glissières avec une serviette propre.

### Étapes d'installation

**REMARQUE :** La méthode d'application peut être légèrement différente de celle représentée par les illustrations.



Nettoyer la glissière de glace avec un tampon à l'alcool.

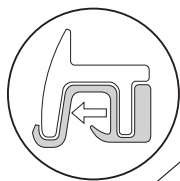

1

Retirer la protection d'adhésif du rebord avant. Décoller 5 cm (2 po) de protection d'adhésif à chaque extrémité du rebord supérieur.

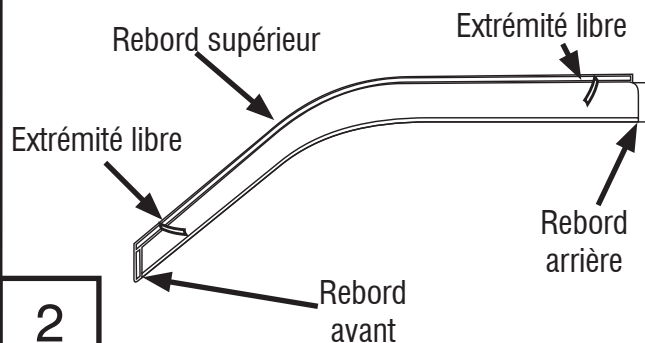

2

## Étapes d'installation

REMARQUE : La méthode d'application peut être légèrement différente de celle représentée par les illustrations.

Insérer le rebord arrière de la visière dans la glissière de glace en premier. Le rebord arrière s'insère entre la garniture de glace et la surface extérieure. Les rebords avant et supérieur s'engagent dans la glissière de glace.

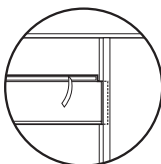

3

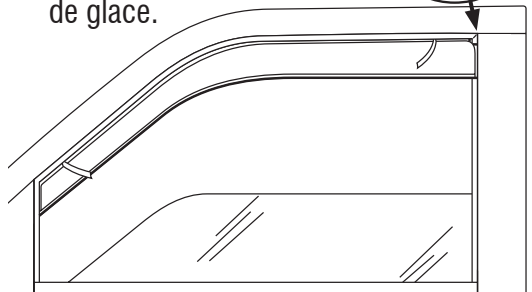

Retirer la protection d'adhésif en tirant sur ses extrémités libres. Relever lentement la glace et la laisser remontée pendant 24 heures afin de permettre à la visière de bien adhérer à la glissière de glace.

4

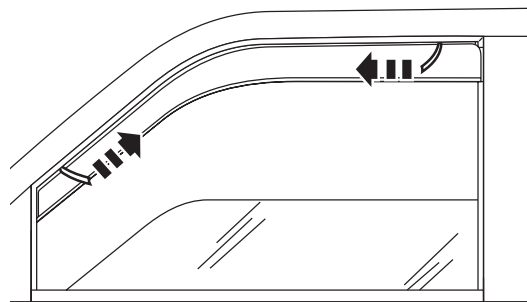

## Ensemble 4 pièces

Installer la visière arrière en utilisant la même méthode de préparation et d'installation que pour la visière avant. Noter que les rebords supérieur et arrière s'engagent en glissant dans la glissière de la glace, et que le rebord avant s'insère entre le caoutchouc et le cadre de glace.

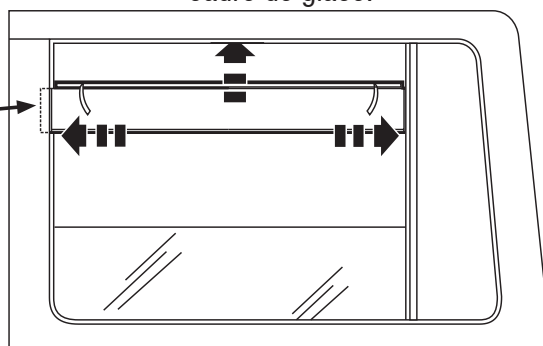
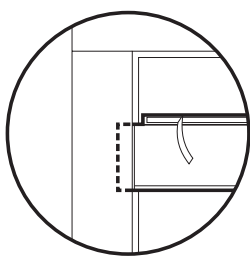

5

Reépéter les étapes 1 à 5 pour les visières restantes

## Entretien et nettoyage

- Laver exclusivement avec de l'eau savonneuse et sécher avec un chiffon propre.

## Félicitations !

Vous avez acheté l'un des nombreux produits de qualité Auto Ventshade™ fabriqués par Lund International, Inc. Nous sommes extrêmement fiers de nos produits et souhaitons que vous tiriez des années de satisfaction de votre investissement. Nous avons pris toutes les mesures nécessaires pour assurer que ce produit est d'une qualité supérieure en ce qui concerne l'ajustement, la durabilité, la finition et la facilité d'installation.



AUTO VENTSHADE™

Lund International, Ventshade Accessories Division

655 Raco Drive, Lawrenceville, GA 30045, USA

800-241-7219 • Fax 770-339-5839 • Visitez notre site [lundinternational.com](http://lundinternational.com)



© 2005 Lund International, Inc. Tous droits réservés.  
Auto Ventshade™, le logo Auto Ventshade™ et le logo AVS™ sont des marques déposées de Lund International, Inc.





## Ventvisor® Deflector

Para una instalación adecuada y el mejor ajuste posible, lea todas las instrucciones ANTES de comenzar. Si desea recibir asistencia técnica u obtener piezas faltantes, llame al Servicio al cliente al 1-800-241-7219.

### Información importante de seguridad



- PRECAUCIÓN - Antes de conducir, asegúrese de que la visera esté correctamente anclada al vehículo.
- No utilice servicios automáticos de limpieza de vehículos que utilizan cepillos.
- No utilice limpiadores al solvente de ningún tipo.
- Compruebe periódicamente que todos los componentes estén ajustados.

### Contenido - Juego de dos piezas

NOTA: El producto real puede variar de la ilustración.



Paños esterilizados x 2

### Contenido - Juego de cuatro piezas

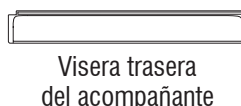
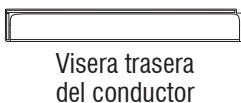

Paños esterilizados x 4

### Herramientas necesarias



Equipo de limpieza de vehículos



Toalla limpia

### Preparación antes de pintar o instalar

- Se recomienda realizar un ajuste de prueba para asegurar el posicionamiento y ajuste correctos.
- Compruebe que las piezas se ajusten correctamente antes de pintarlas, ya que no aceptaremos la devolución de piezas modificadas o pintadas.
- Lave los canales de la ventanilla del vehículo para quitar los desechos y la suciedad.
- Seque los canales de la ventanilla con una toalla limpia.

### Pasos de instalación

AVISO: La colocación real puede variar con respecto a las ilustraciones.

Alcohol Pad

Limpie el canal de la ventanilla con un paño esterilizado.

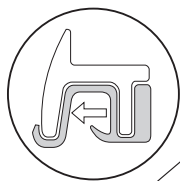

1

Quite la cinta protectora del reborde frontal. Retire 2 pulgs. (5 cm) de cinta protectora de cada uno de los extremos del reborde superior.

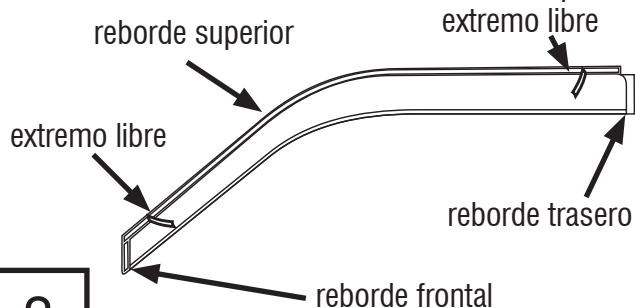

2

## Pasos de instalación

**AVISO:** La colocación real puede variar con respecto a las ilustraciones.

Inserte la visera en el canal de la ventanilla comenzando con el reborde trasero. El reborde trasero se introduce entre la banda lateral y la superficie exterior. El reborde superior frontal se desliza por el canal de la ventanilla.

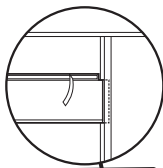

3

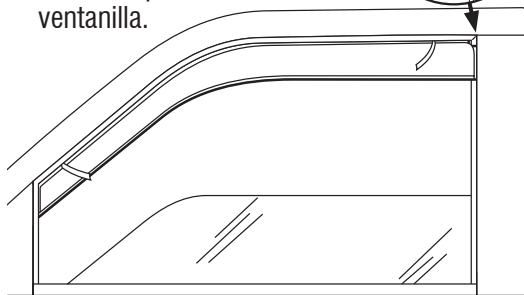

Retire la cinta protectora tirando de los extremos libres. Levante la ventanilla lentamente y déjela en esa posición por 24 horas para que la visera se fije en el canal de la ventanilla.

4

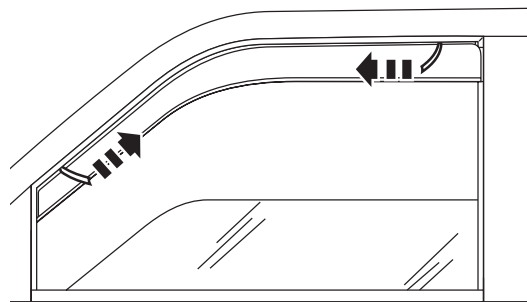

## Juego de cuatro piezas

Instale la visera trasera con los mismos métodos de preparación e instalación que utilizó para la visera frontal. Tenga en cuenta que los rebordes superior y trasero se adhieren al canal de la ventanilla y el reborde frontal se inserta entre la goma y el marco de la ventanilla.



5

Repita **los pasos 1 a 5** para las viseras restantes

## Cuidado y limpieza

- Limpie solamente con agua jabonosa tibia y seque con un paño limpio.

## Felicidades

Usted ha comprado uno de los tantos artículos de calidad de Auto Ventshade™ ofrecidos por Lund International, Inc. Nuestros productos son nuestro mayor orgullo. Deseamos que disfrute de años de satisfacción con su inversión. Hemos realizado todos los esfuerzos para asegurarnos de que su producto sea de la mejor calidad en cuanto a ajuste, durabilidad, acabado y facilidad de instalación.



AUTO VENTSHADE™

Lund International, Ventshade Accessories Division

655 Raco Drive, Lawrenceville, GA 30045

800-241-7219 • Fax 770-339-5839 • Visite nuestro sitio Web: [lundinternational.com](http://lundinternational.com)



™ Auto Ventshade™, el logo de Auto Ventshade™ y el logo de AVS™ son marcas comerciales de Lund International, Inc.

