

GOLF R / S3 CATBACK EXHAUST

#TL100112



INSTALLATION
INSTRUCTIONS



Notes:

These instructions were written for a North American specification Mk7 Golf R. Other vehicles, like the S3, are similar.

When disassembling the car, be sure to keep all fasteners so they can be reused. It is recommend that you get some kind of compartmented tray to organize the fasteners, such as a fishing tackle box or several large ice cube trays. Fasteners that are not reused for reinstallation are noted in the instructions. All directions used in this manual (right, left, front, etc.) are based on if you were sitting in the drivers seat of the car.

These instructions assume that you have basic mechanical skills and several varieties of basic hand tools in order to install the kit. If you have any questions about the install, feel free to contact your APR representative.



WWW.GOAPR.COM

4800 US HWY 280 West Opelika Alabama 36801

TL100112



1) Securely lift vehicle. If a vehicle lift is not used, secure the vehicle with jack stands.

APR

2) Remove the four 13mm nuts holding the brace at the back of the center tunnel, and remove the brace from the car.

This car is equipped with an APR downpipe. Loosen the four 13mm nuts holding the two sleeve clamps on both ends of the sleeved reducer.

If the car has a stock downpipe, loosen the two 13mm nuts on the stock sleeve clamp between the stock downpipe and the stock catback.

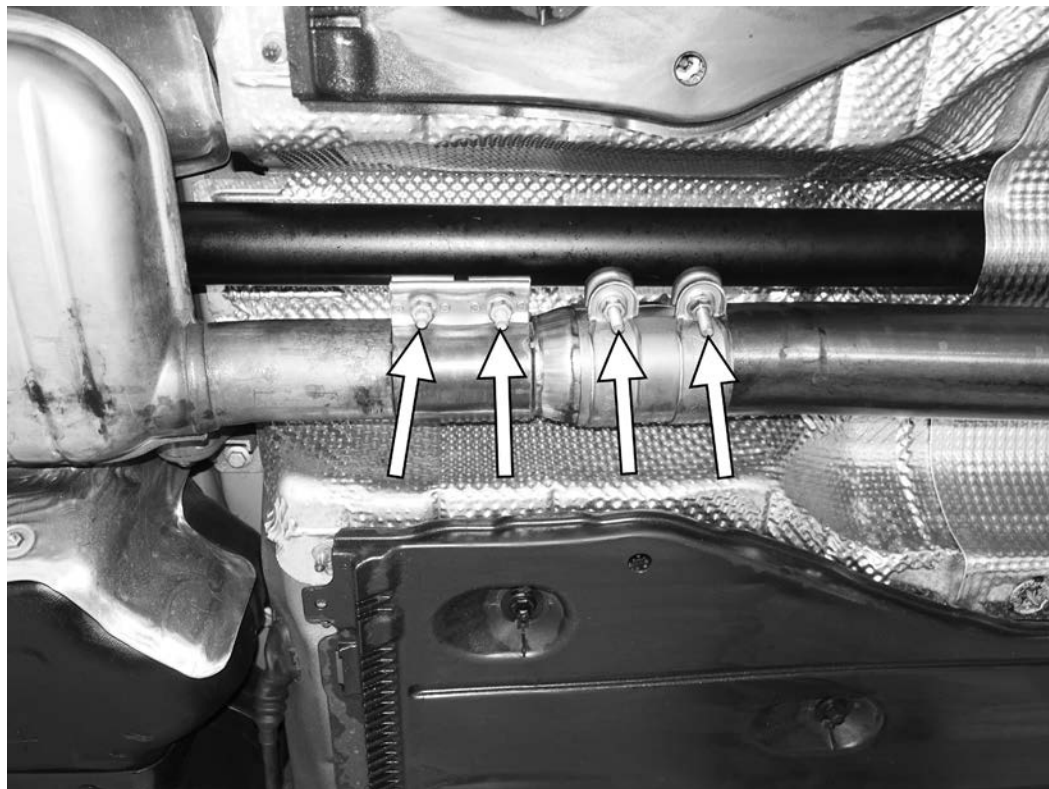

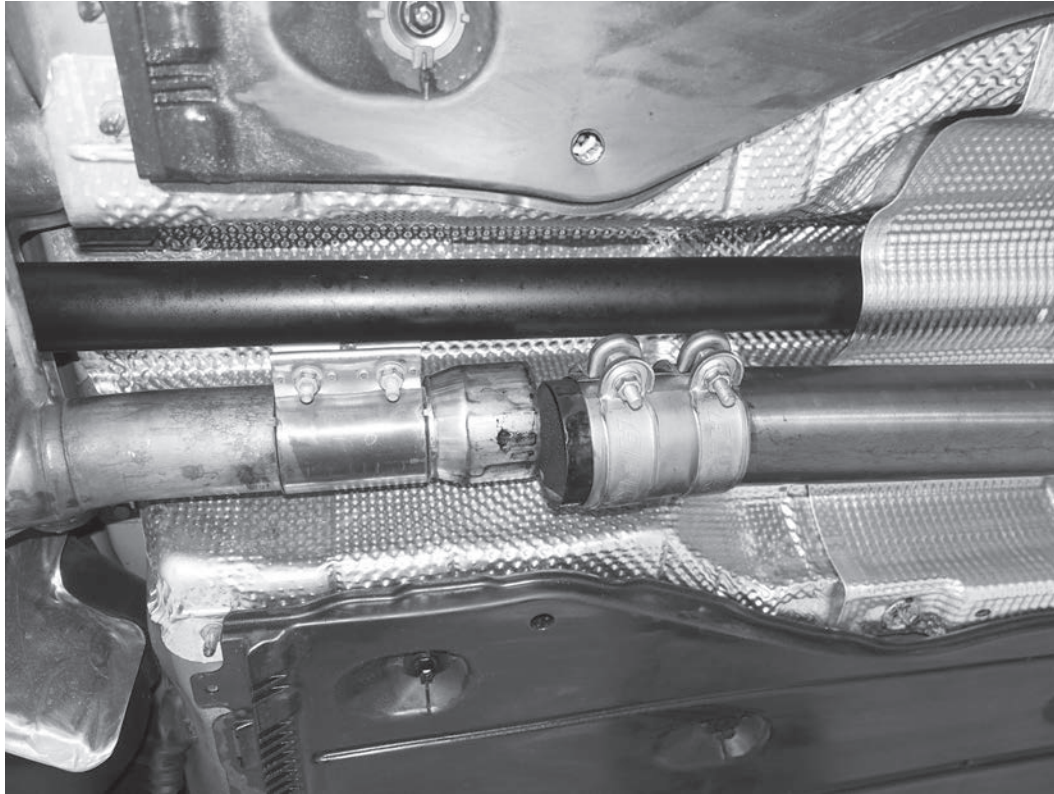

3) Slide the sleeve clamp(s) forward or back off the exhaust pipe to separate the downpipe from the rest of the exhaust.

APR

4) Locate the two factory exhaust flap motors, just in front of and inside the rear bumper, one on each side of the car. Disconnect the electrical connector from the flap motors. To do so, slide the grey tab away from the connection, and then press down on the grey tab to unlock the connector from the motor.

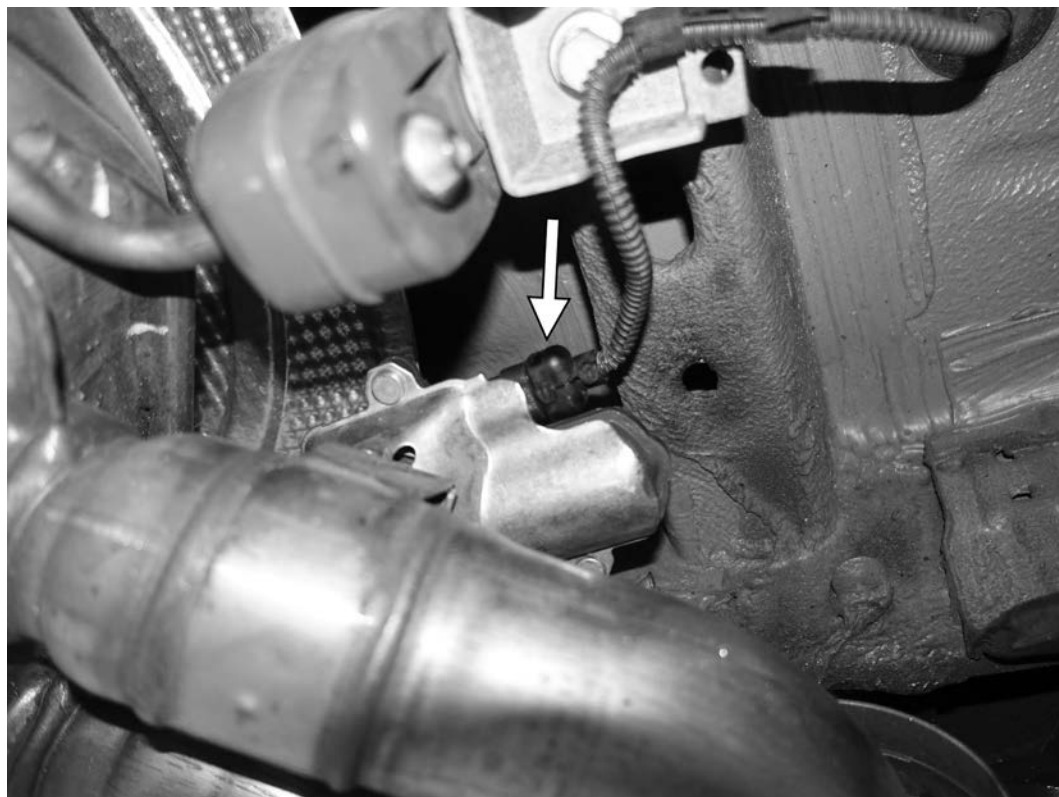

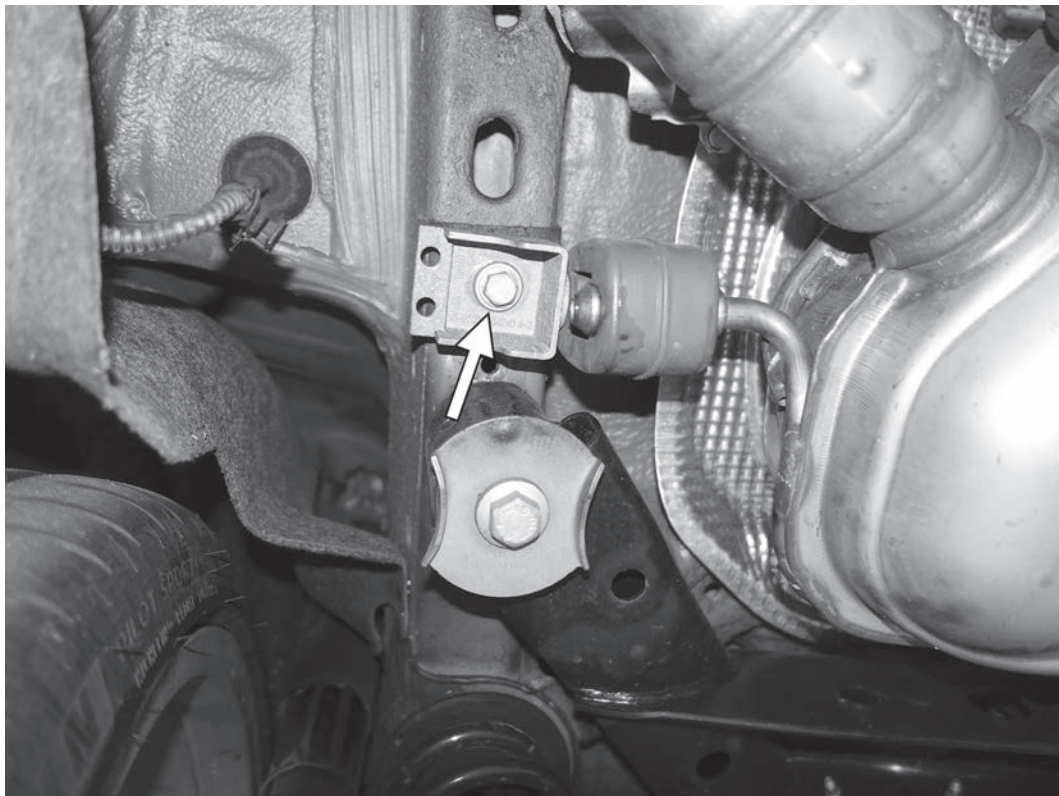

5) Loosen but do not remove the two 13mm bolts on both sides of the rear muffler hanger mounting brackets.

6) Using a pry bar or exhaust hanger removal tool, separate the rubber hanger from the stock catback near the front right of the front muffler, just behind the center tunnel of the car. Leave the rubber hanger attached to the car.



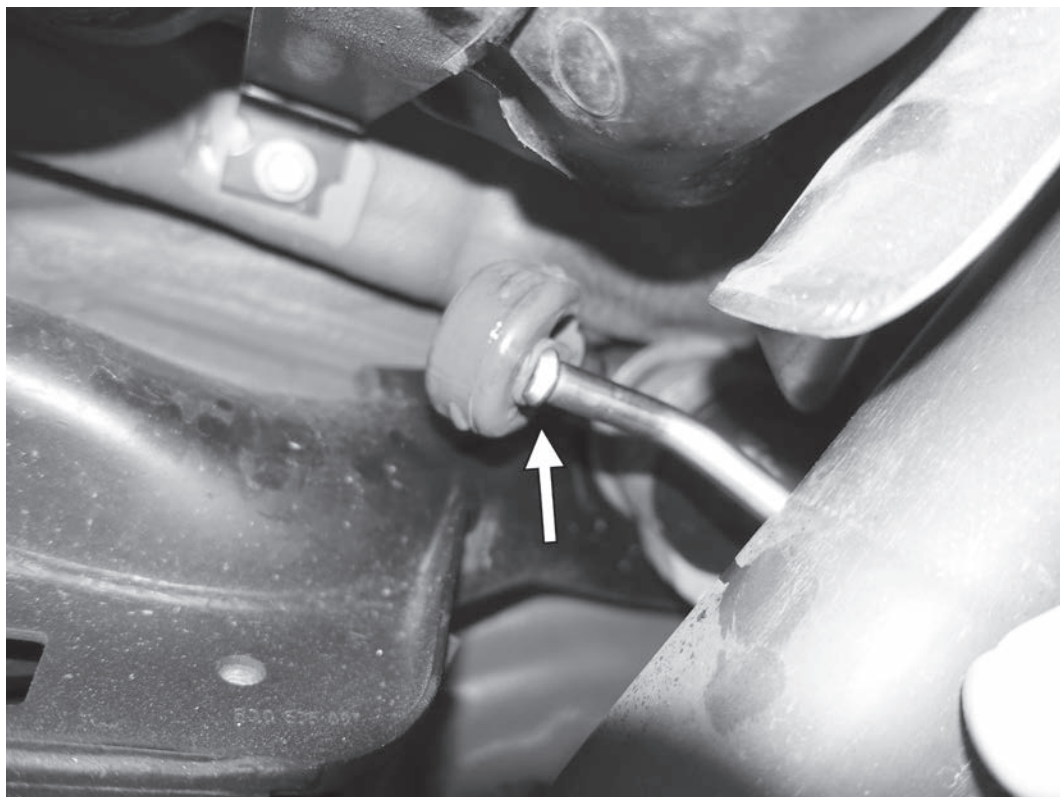

7) With an assistant to support the exhaust, use a pry bar or exhaust hanger removal tool to separate rubber hanger from the left side of the stock catback, just in front of the subframe. Leave the rubber hanger attached to the car.

8) With an assistant holding the stock exhaust, remove the two previously loosened 13mm bolts on both sides of the rear muffler hanger mounting brackets. Carefully lower the exhaust and place on the ground away from the car.





9) If installing a valveless exhaust system on a car with exhaust valves, install the two supplied dummy plugs onto the harnesses for the two flap motors. Use the supplied cable ties to secure the harnesses out of the way. Once complete, skip to step 17 of this manual.

10) On the right rear of the stock cat-back, remove the three 8mm nuts holding the flap motor to the stock exhaust and remove the flap motor. Look into the far right exhaust tip with a mirror and a flashlight, and note the orientation of the exhaust flap. The stock exhaust flap inside the exhaust tube should be open.



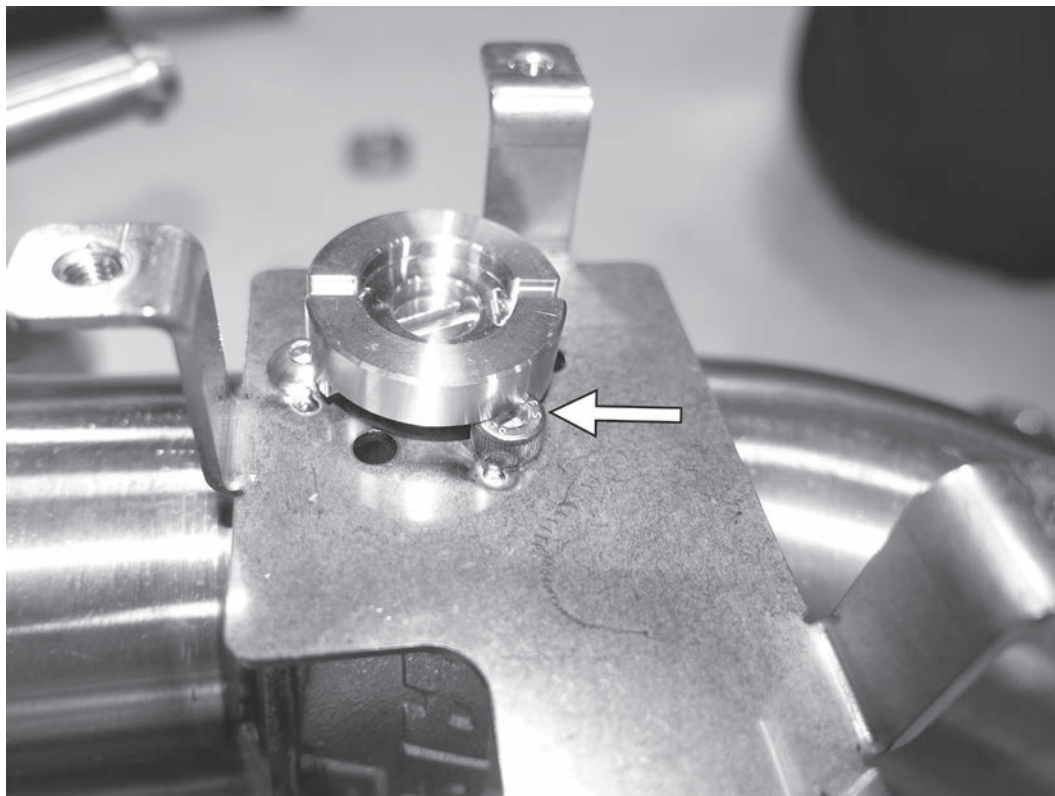

11) On the right side of the APR rear muffler install the supplied spacer on the right motor flap bracket. With the APR exhaust flap open, the slots on the top of the spacer should be in line with the exhaust flap. The slot on the bottom of the spacer should have clearance on the one bolt with the raised head that holds the bracket to the APR rear muffler.

12) Install the stock exhaust flap motor onto the APR spacer, making sure the motor is roughly oriented correctly on the APR bracket AND that the slots from the spring on the bottom of the flap motor sit in the slots of the APR spacer. It may be necessary to put the spring slots in the APR spacer first and then rotate the flap motor slightly to get the flap motor holes to orient with the APR bracket.

Note that the factory spring may sometimes fall off the flap motor, simply place the spring back on the flap motor as shown before assembly.





13) Secure the exhaust flap motor to the APR bracket with the three supplied washers and 5mm allen screws. Torque the three screws to 3Nm (26 lb-in).

APR

14) On the left rear of the stock cat-back, remove the three 8mm nuts holding the flap motor to the stock exhaust and remove the flap motor. Look into the far left exhaust tip with a mirror and a flashlight, and note the orientation of the exhaust flap. The stock exhaust flap inside the exhaust tube should be open.



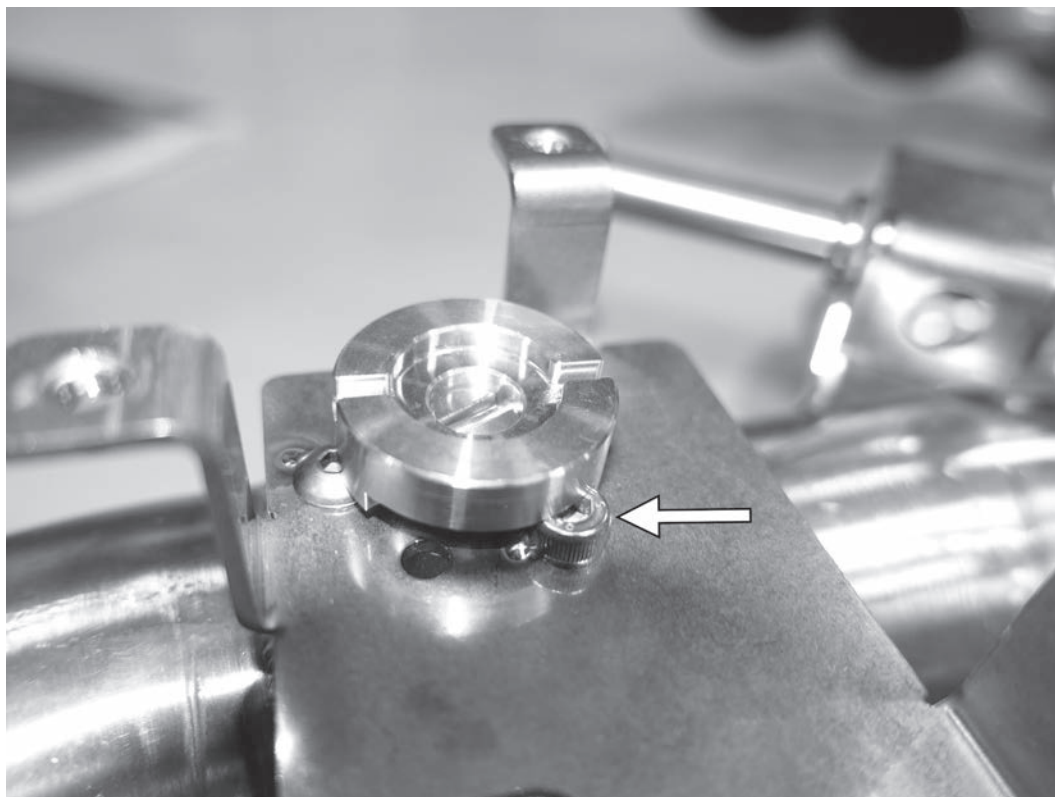

15) On the left side of the APR rear muffler install the supplied spacer on the right motor flap bracket. With the APR exhaust flap open, the slots on the top of the spacer should be in line with the exhaust flap. The slot on the bottom of the spacer should have clearance on the one bolt with the raised head that holds the bracket to the APR rear muffler.

APR

16) Install the left stock exhaust flap motor onto the APR spacer, making sure the motor is roughly oriented correctly on the APR bracket AND that the slots from the spring on the bottom of the flap motor sit in the slots of the APR spacer. Then, secure the exhaust flap motor to the APR bracket with the three supplied washers and 5mm allen screws. Torque the three screws to 3Nm (26 lb-in).

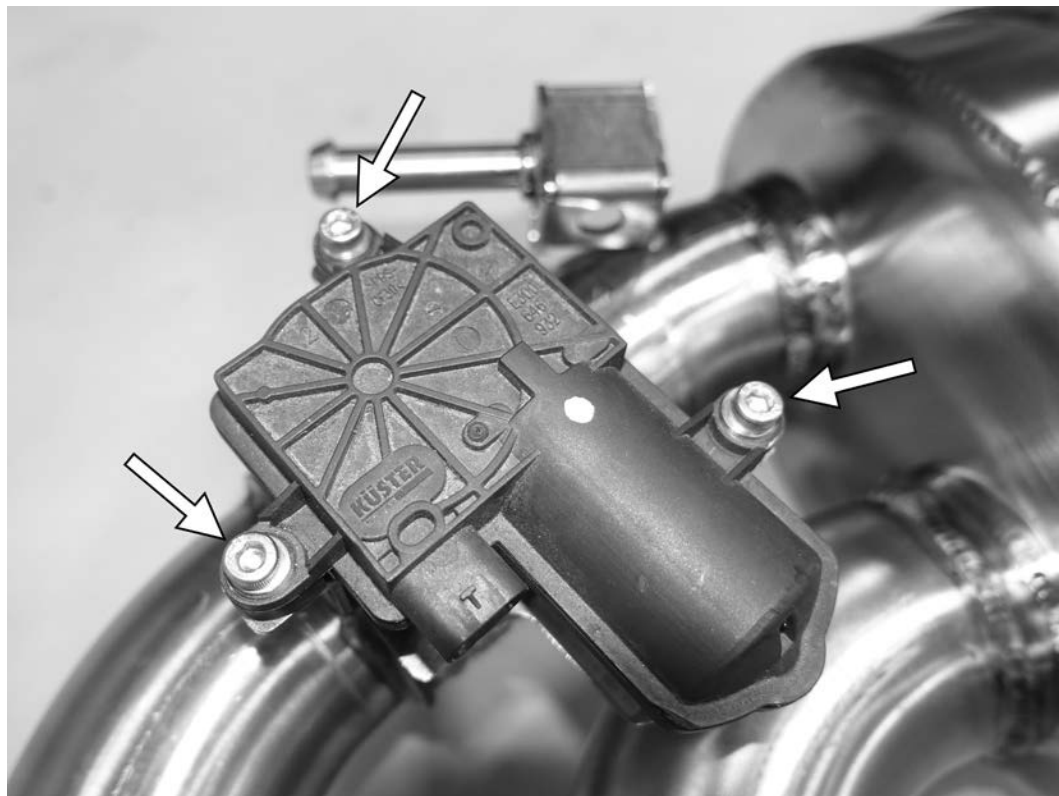

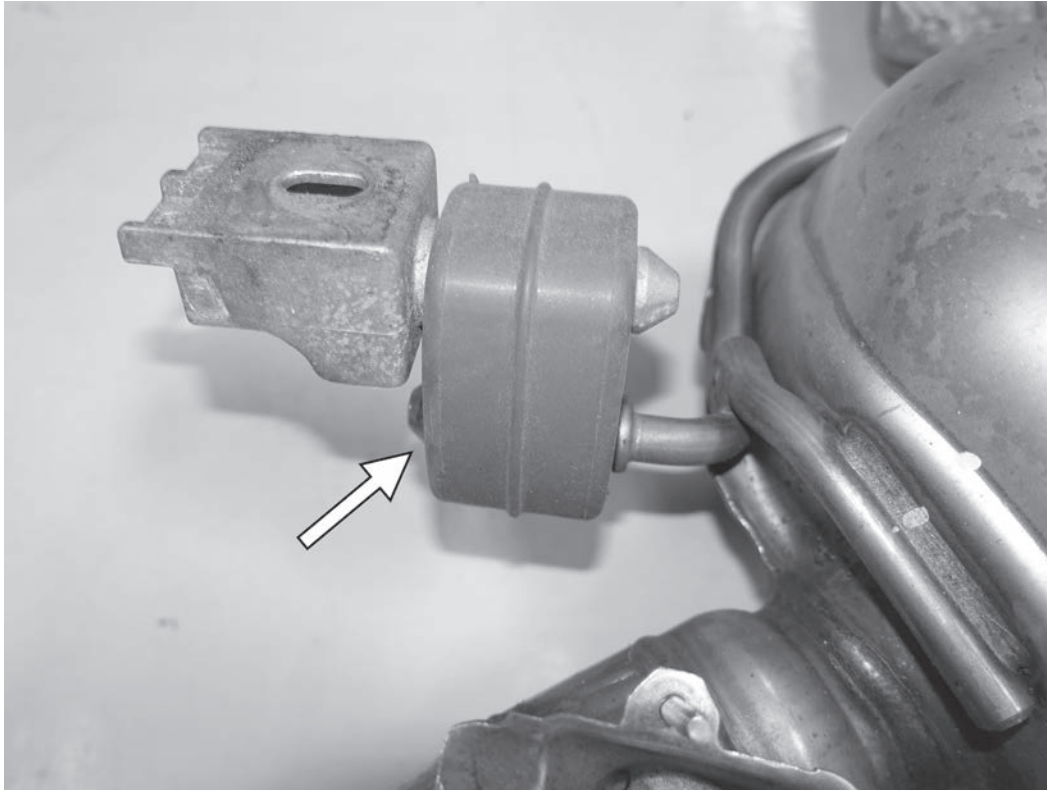

17) With a pry bar or exhaust hanger removal tool, separate the left rubber exhaust hanger with the mounting bracket from the rear muffler of the stock catback. Also separate the right hanger assembly from the stock catback. Some spray lubricant may help with removing these rubber hangers.

18) Install the exhaust hanger assemblies onto both sides the APR exhaust in the same orientation. Spray lubricant will help with installing the rubber hangers.

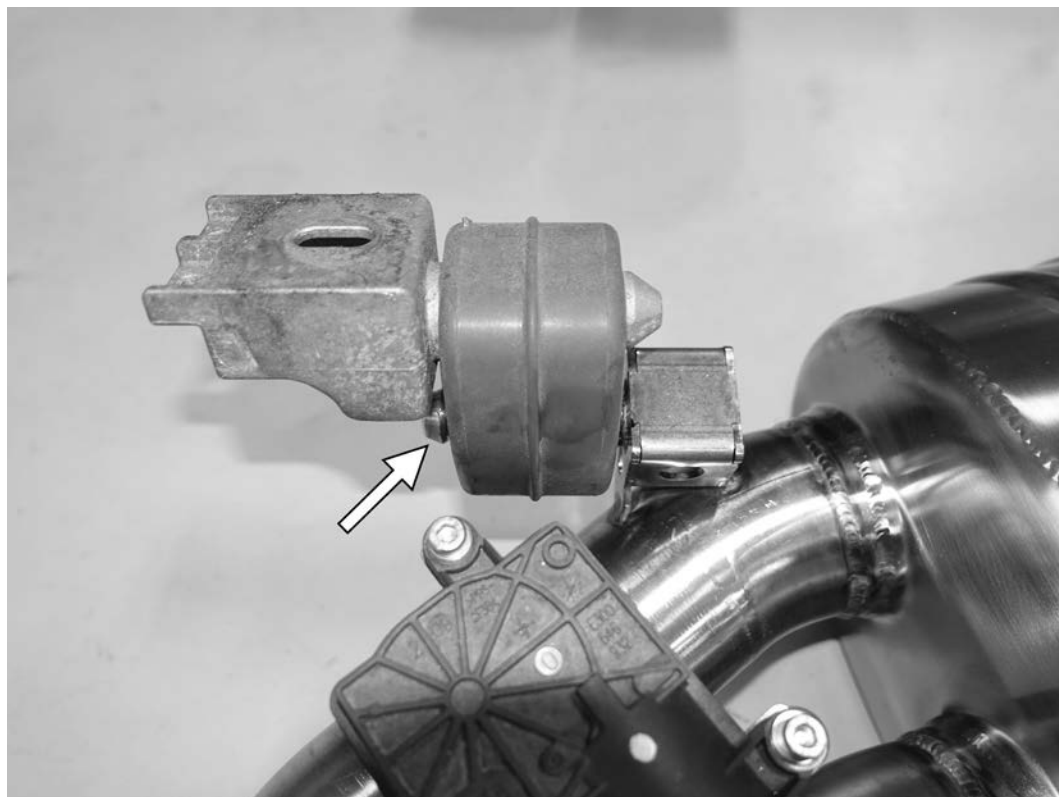

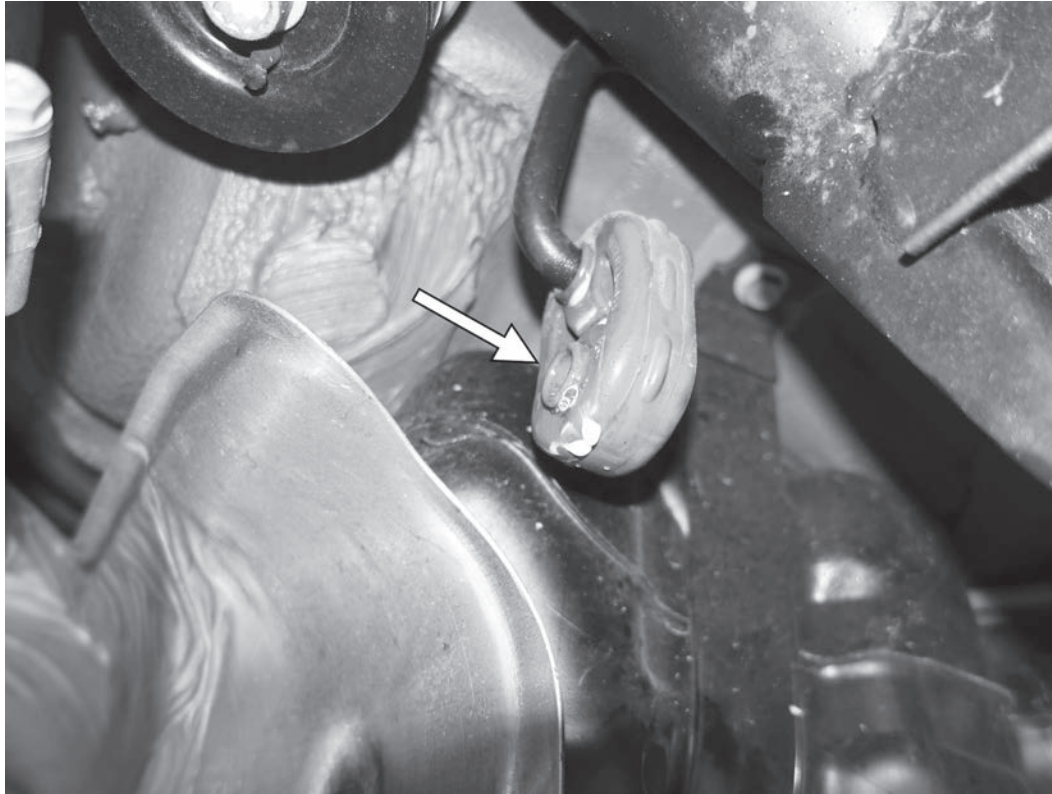

19) Put spray lubricant on the two rubber hangers for the center exhaust pipe that should still be installed in the car.

20) With an assistant, raise the APR rear muffler assembly up into the car. Reinstall but do not tighten the two 13mm bolts to the rear muffler hanger mounting brackets.

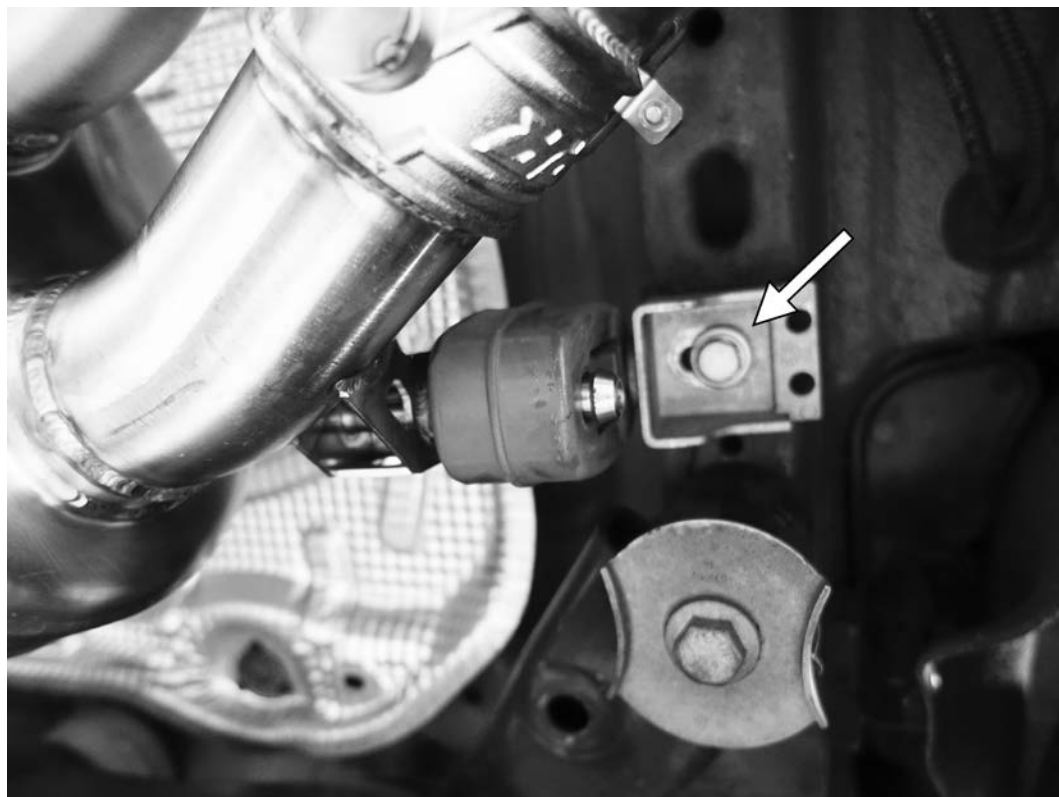

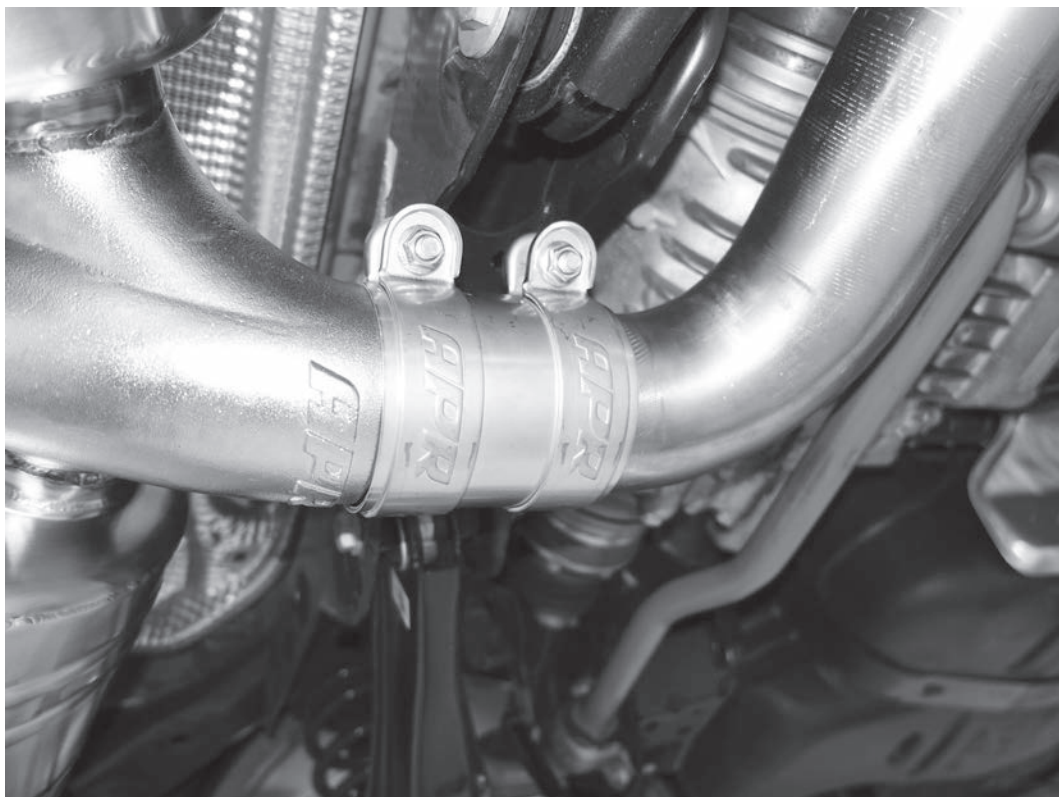

21) Loosely place a sleeve clamp onto the inlet of the APR rear muffler assembly, and then slide the rear of the APR center pipe into the other end of the sleeve clamp.

APR

22) Put the post from the APR center pipe into the factory rubber hanger on the left side of the car, just in front of the rear subframe.



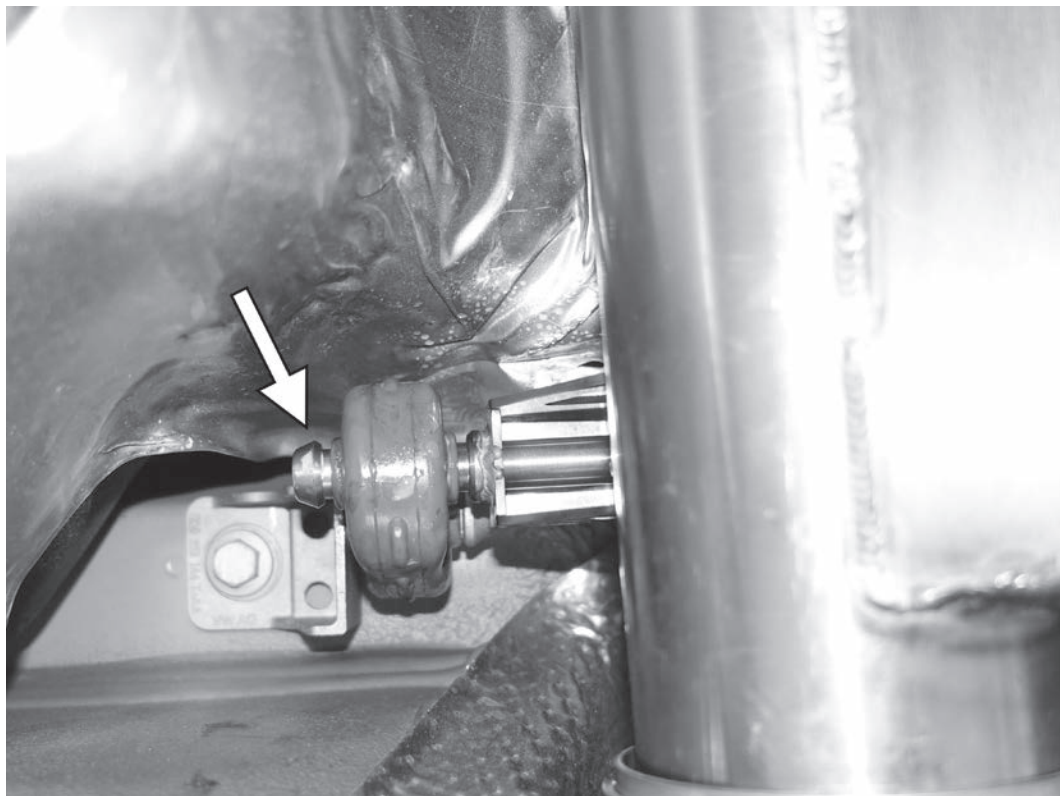

23) Install the post from the front of the APR center pipe into the rubber factory hanger on the right side, just behind the center tunnel of the car.

APR

24) With two sleeve clamps, install the short, supplied piece of pipe between the APR downpipe and the APR catback. Adjust the exhaust system for fitment, and then tighten the four 13mm nuts on the sleeve clamps to 25Nm (18 lb-ft).

If you are using the stock downpipe, use the supplied APR reducer to connect between the stock downpipe and the APR catback exhaust.



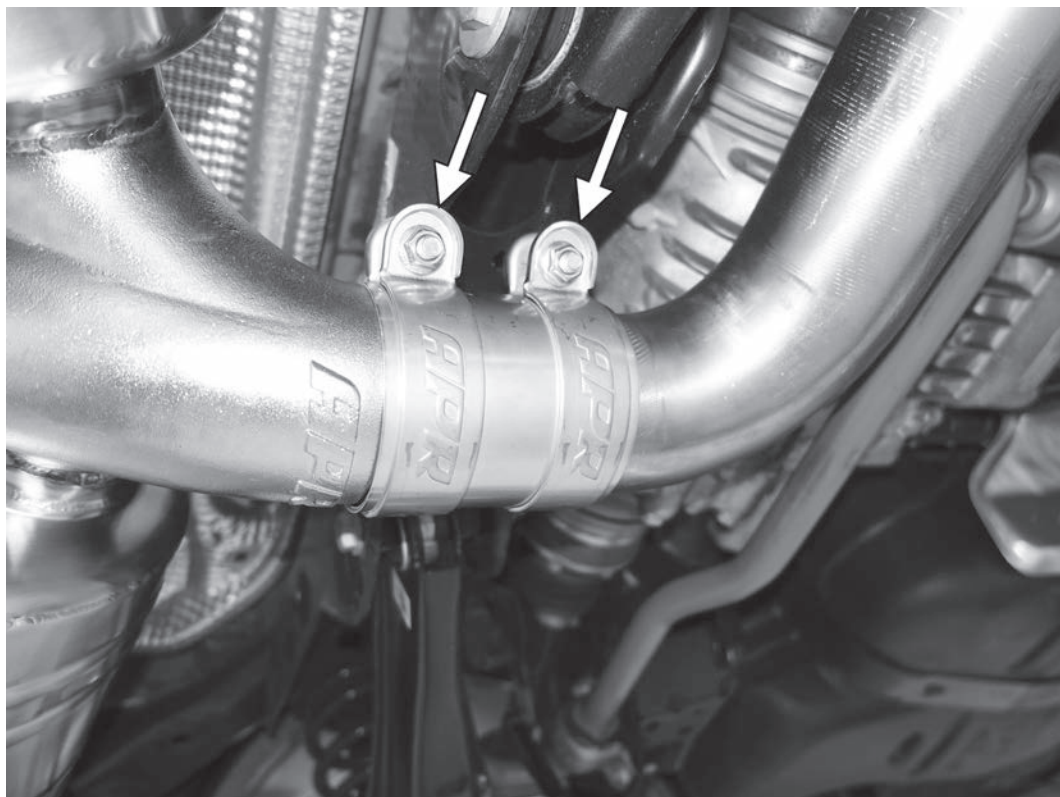

25) Adjust the angle of the rear muffler to the center pipe, and then tighten the sleeve clamps to 25Nm (18 lb-ft).

26) With the rear 13mm bolts on the rear muffler hanger mounting brackets loose, adjust the rear muffler so the outlets are centered in the rear valence. Tighten the 13mm bolts to 20Nm (15 lb-ft).

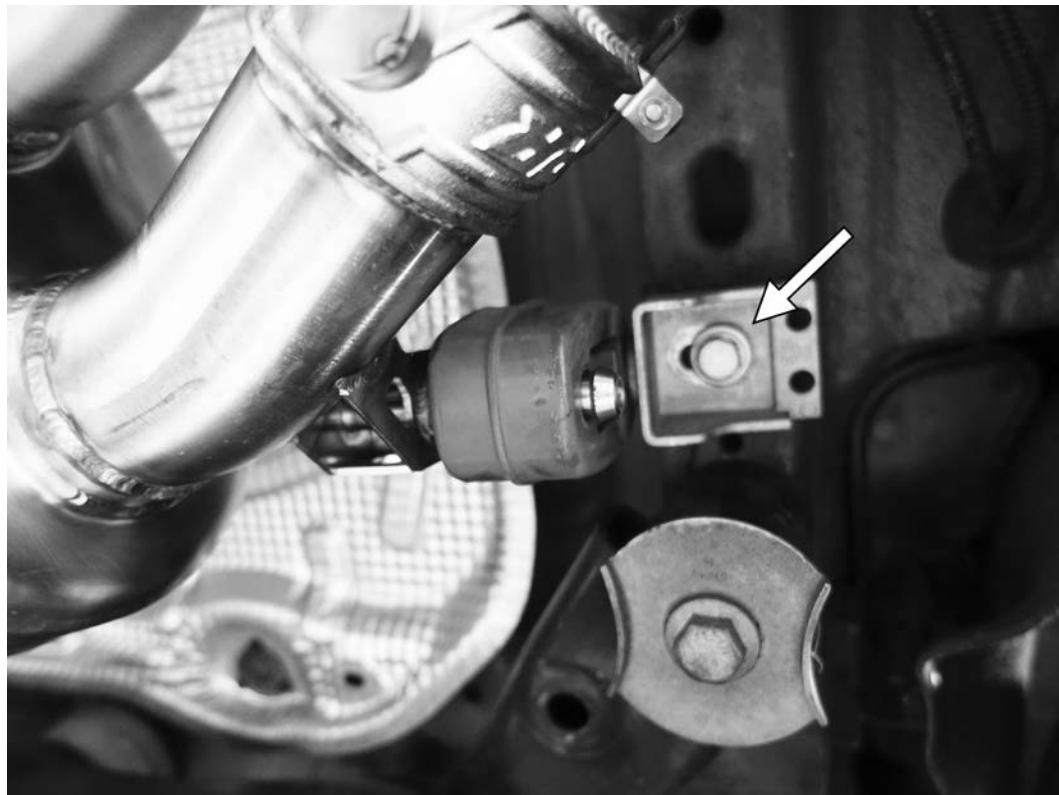

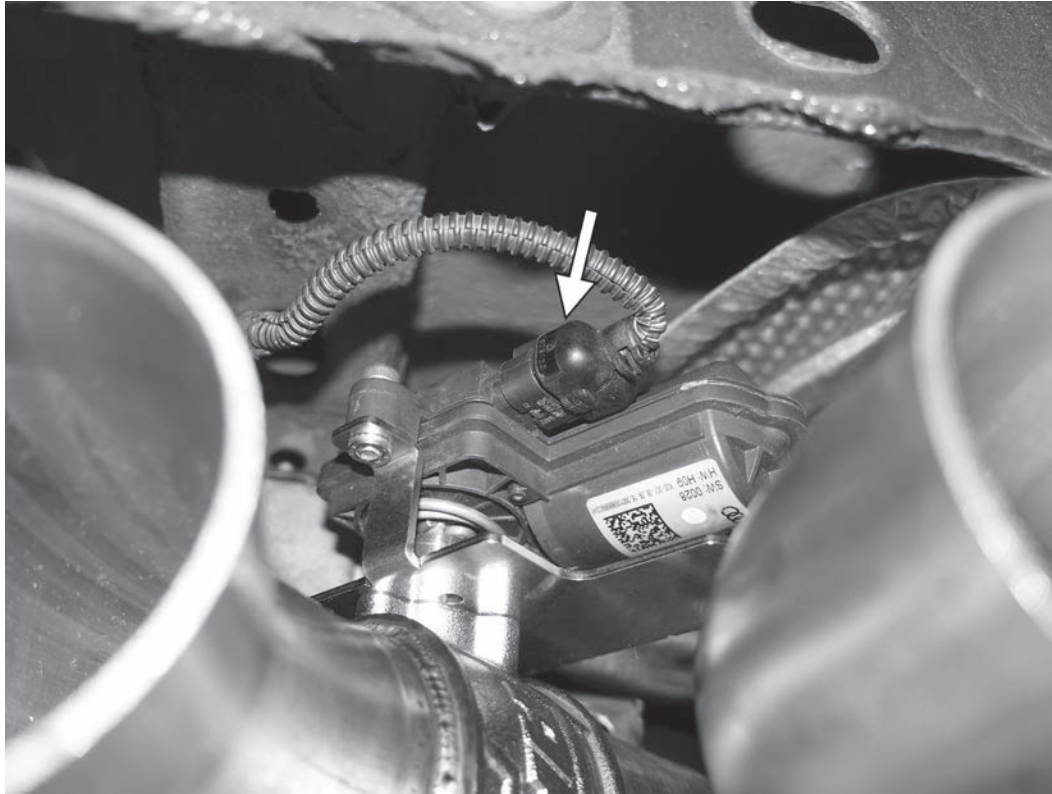

27) Reconnect the electrical connectors to both factory exhaust flap motors, being sure to slide the grey clip to the locked position after the connector clicks in place.

28) Install one of the APR exhaust tips with an APR pinch clamp on the right exhaust outlet of the right muffler. Make sure the "P" in the APR logo is facing directly up.



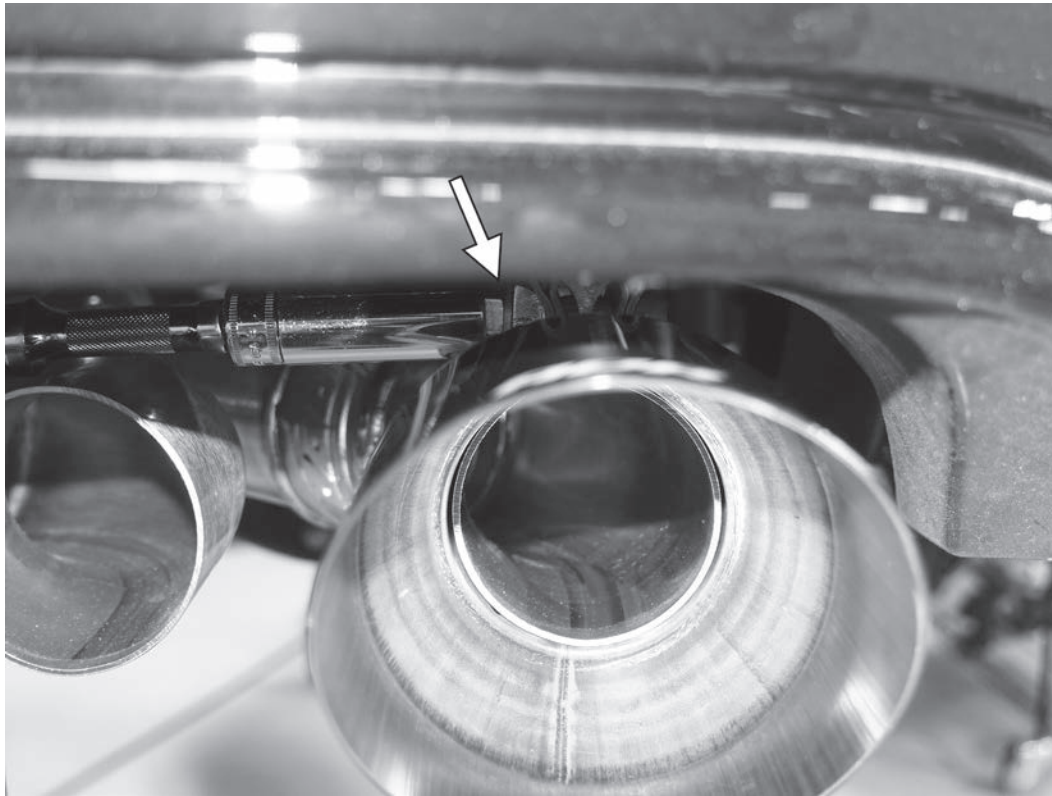

29) With the “P” in the logo facing up, center the APR tip on the exhaust outlet as best as possible, and then tighten the pinch clamp to 55Nm (40 lb-ft). The APR tips should be centered based on the APR ear muffler outlets, not on where they sit in the rear valence.

APR

30) Repeat the tip installation process on the remainder of the tips, working from right to left.



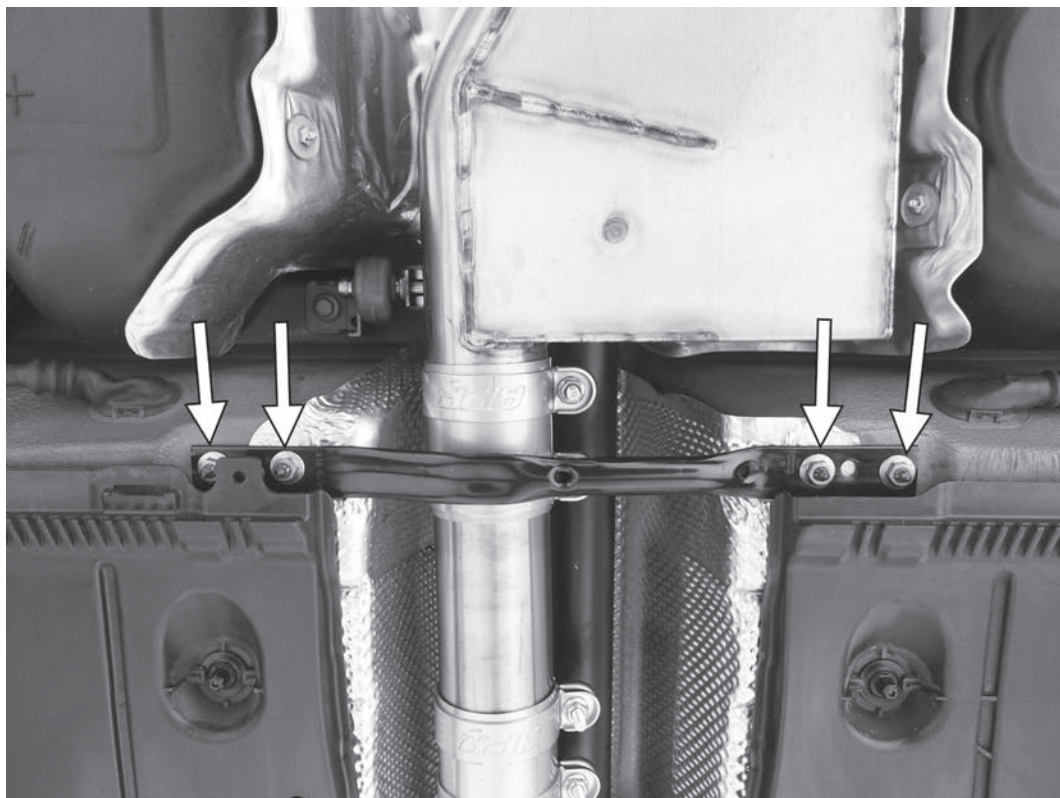

31) Reinstall the center cross brace with the four 13mm nuts. Torque the nuts to 20Nm (15 lb-ft).

32) Before running the car, wipe down the entire exhaust system with a mild cleaning agent to remove any handprints created during the installation. Once heated, the handprints become more pronounced and are harder to remove

Also, while the APR exhaust is 304L stainless steel, outside contaminants can cause the exhaust to get surface rusting. This can be removed using either a rag (on polished surfaces) or a green Scotch-Brite™ pad (on brushed surfaces) and a cleaning product high in oxalic acid, like Bar Keepers Friend®



APR

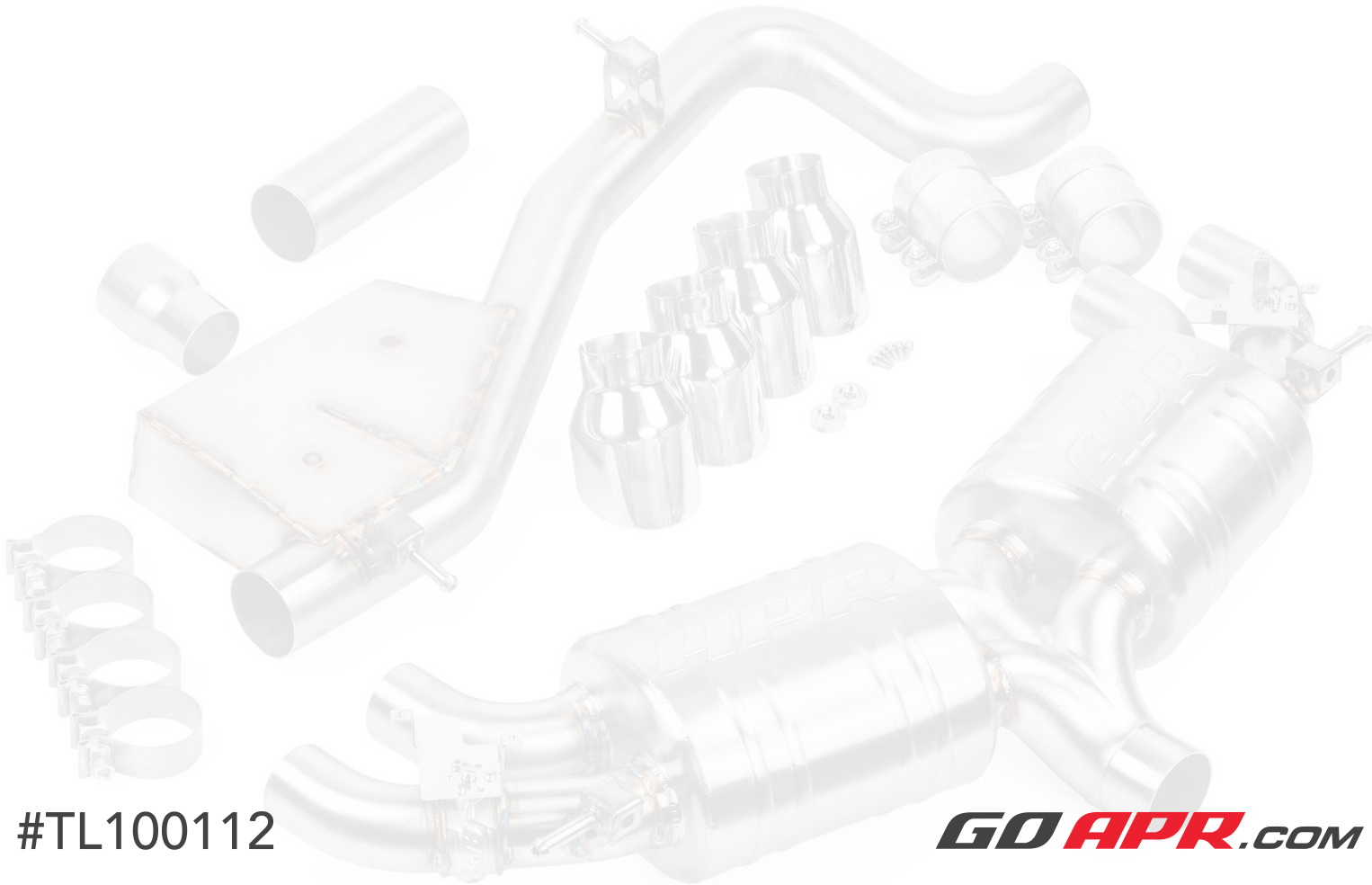

#TL100112

GO APR.COM