



INSTALLATION

2.0 TURBO
STAGE III



APR, LLC

1027 Opelika Road Auburn Alabama 36830

www.goapr.com

+1.334.502.5181

NOTES:

Before attempting to install an APR Stage III Upgrade yourself, ask yourself if you think you are up to the task. While fairly straightforward, this is an extensive kit and will take a novice mechanic more than a weekend to install. Also be aware that the ECU needs to be sent to APR to be programmed, so you will need to plan appropriate time for shipping.

These instructions were written for a MkV VW GTI/Jetta, but other models (Audi A3, VW EOS) are similar.

These instructions assume that you have basic mechanical skills and several varieties of the tools listed in order to install the kit. If you have any questions about the install, feel free to contact your APR representative.

While your friend's dad may have an "awesome set of tools", there are several specialty items that may not be in your average mechanics toolbox. In addition to basic mechanics tools (metric and standard socket sets, screwdrivers, hand tools, etc.), the following items listed below are needed:

Combination Wrenches: 17mm Flare, 24mm, 18mm, 1"

Sockets: T25 Torx, T30 Torx, 8mm Triple Square, 10mm Triple Square, 12mm Triple Square, 4mm, 24mm, 27mm, 5mm Allen, 6mm Allen, Spark Plug Socket

When disassembling the car, be sure to keep and mark all fasteners so they can be reused if needed. It is recommended that you get some kind of compartmented tray to organize the fasteners, such as a fishing tackle box or several large ice cube trays. Fasteners are referred to by the type of tool used to remove them.

If installing an APR intercooler at the same time as doing the Stage III install, it is advisable to perform steps 4-31 of the intercooler install after step 10 of the Stage III install. Finish the intercooler install, steps 32-53, after you complete step 53 of the Stage III. This will increase access to several components, and will make the installation easier.



1) Support the car on jack stands or a lift. Open the hood and disconnect the 10mm negative battery terminal.

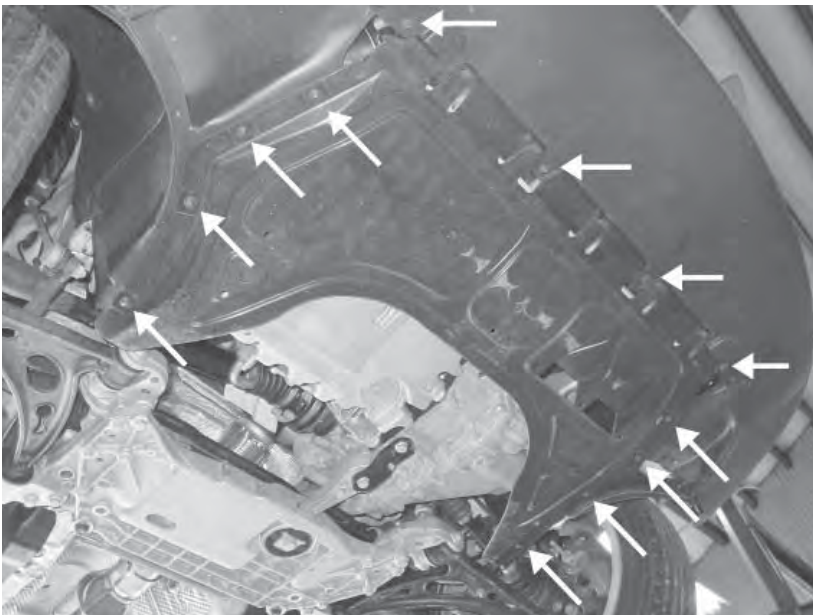

2) Remove the belly pan on the car with a T25 Torx.

3) Remove the two T25 screws that connect the intake ducting to the radiator support. Then remove the hose clamp next to the round accordion tube, and remove the intake from the car.

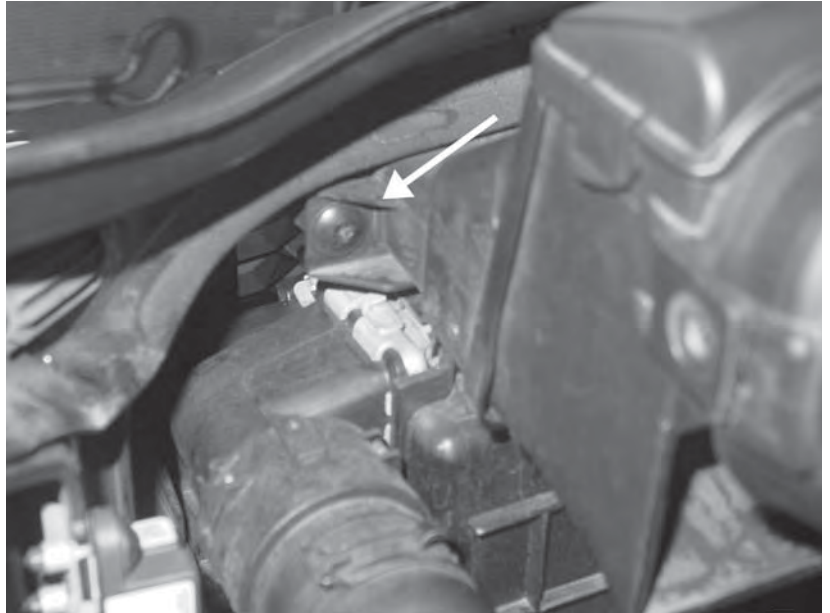

4) Disconnect MAF sensor and remove plastic compressor inlet hose.

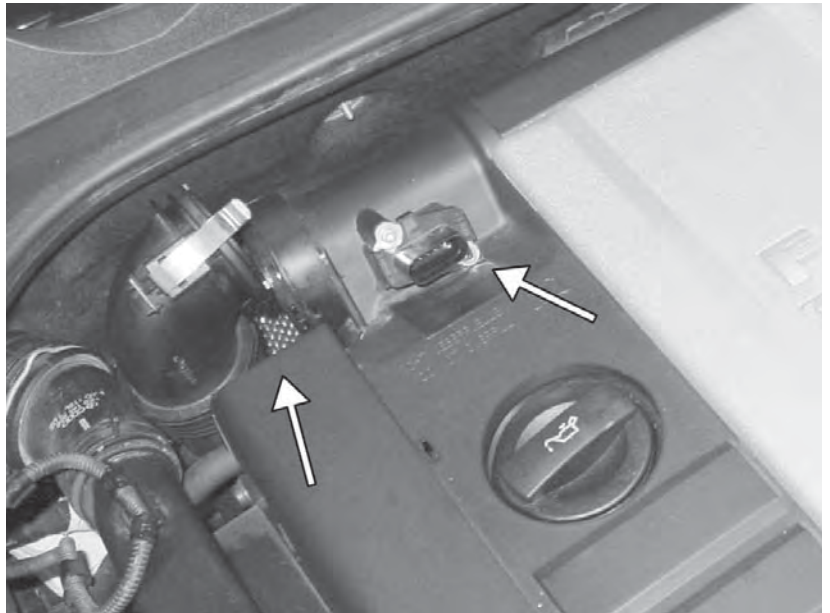

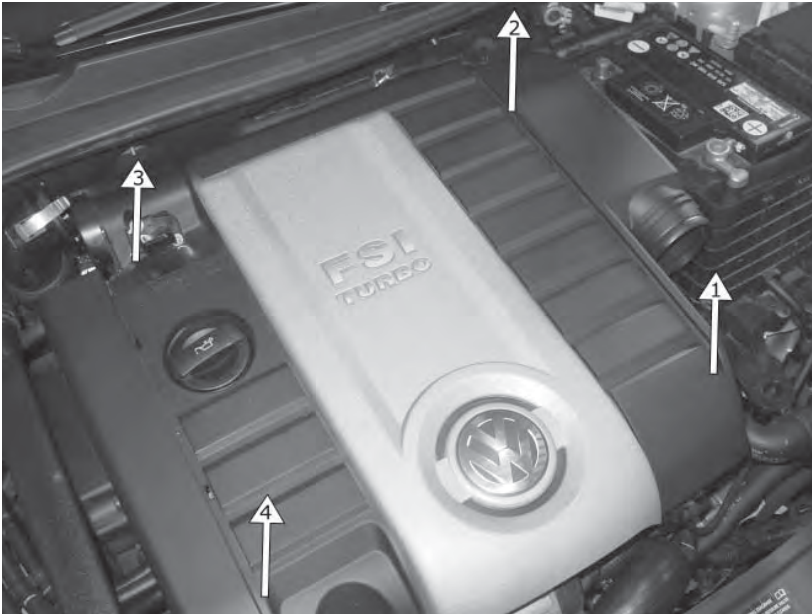

5) Remove the factory airbox assembly from the engine by lifting on the cover in the following order: Driver Front, Driver Rear, Passenger Rear, Passenger Front. The airbox will come out easily if done in this sequence. There are four rubber grommets that connect the airbox to the engine. Make sure they are still attached to the airbox.

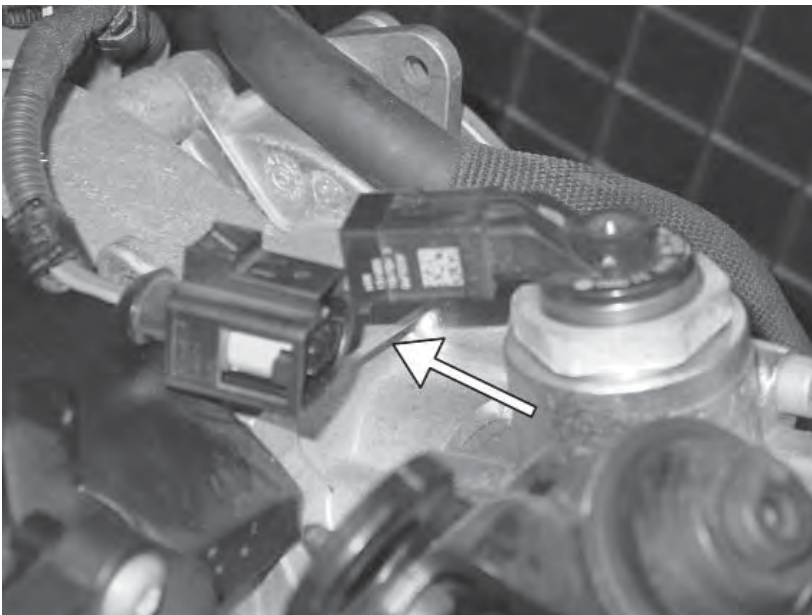

6) Disconnect the fuel pressure regulator electrical connector, start the engine and let it idle for approximately ten seconds before turning it off.

7) Pry off the plastic caps covering the windshield wiper bolts and remove the 13mm bolts. Remove the windshield wiper. Carefully working from one side to another, remove the plastic cowl trim by pulling away from the windshield.



8) Remove the two 10mm bolts from the upper cowl panel. Once removed, unclip the wiring harness that is connected to the backside of the panel. Carefully lift the panel out of the car.

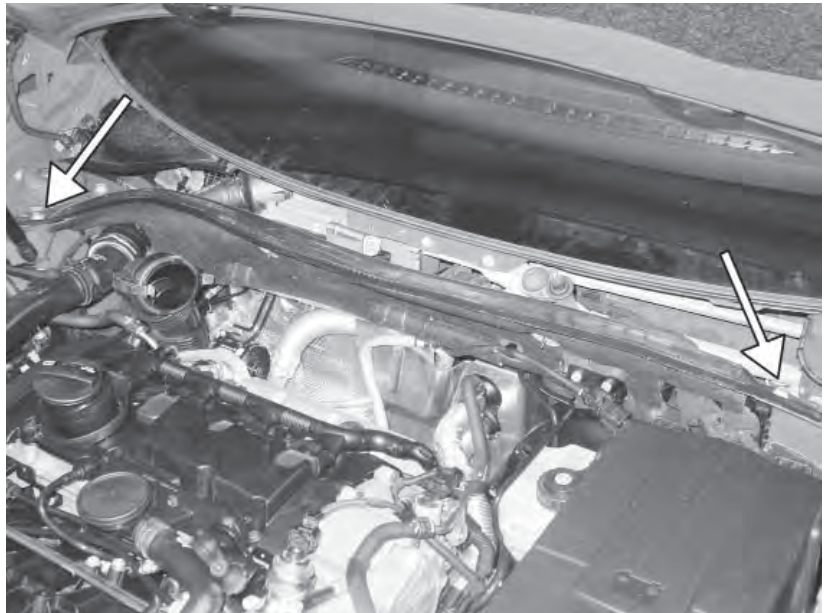

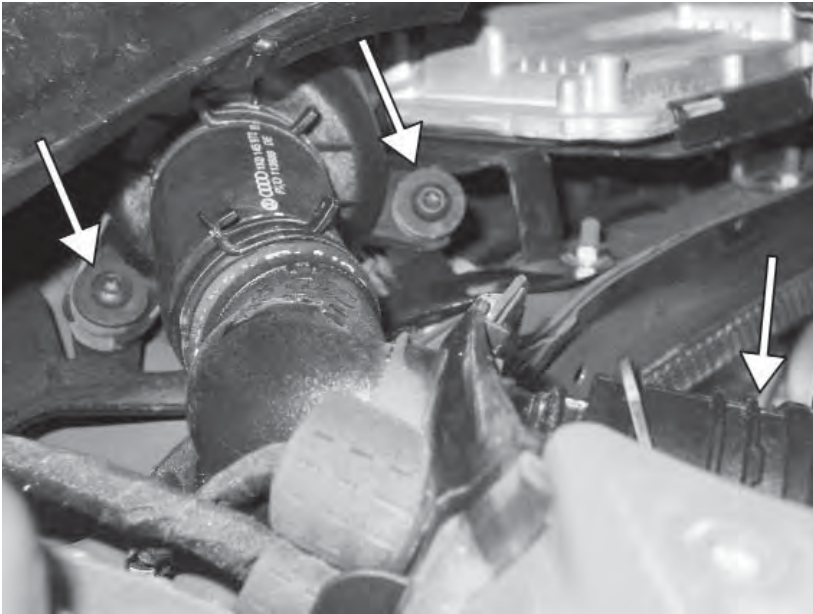

9) Disconnect the clip from the factory noise tube by the firewall. Remove the two T30 bolts from the resonance chamber and move the chamber aside.

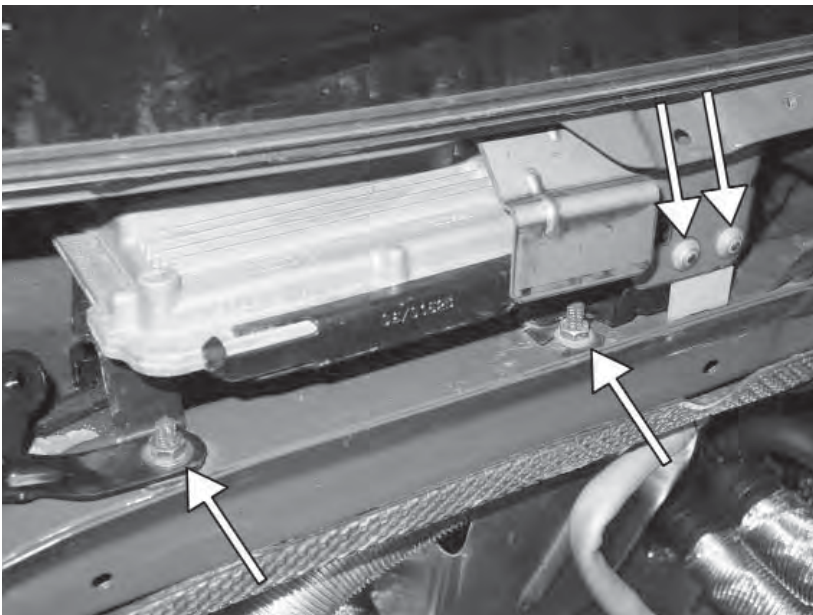

10) Remove the two 10mm nuts holding the ECU bracket. Remove the two security screws from the wiring harness bracket. Remove the wiring harness and remove the ECU from the car.

11) Remove the plastic cap from the pressure release valve on the side of the fuel pump. Place a rag under the fuel pump and depress the Schrader valve to release any additional fuel pressure. Once the pressure is gone, remove the pressure release valve from the fuel pump with a 13mm wrench.

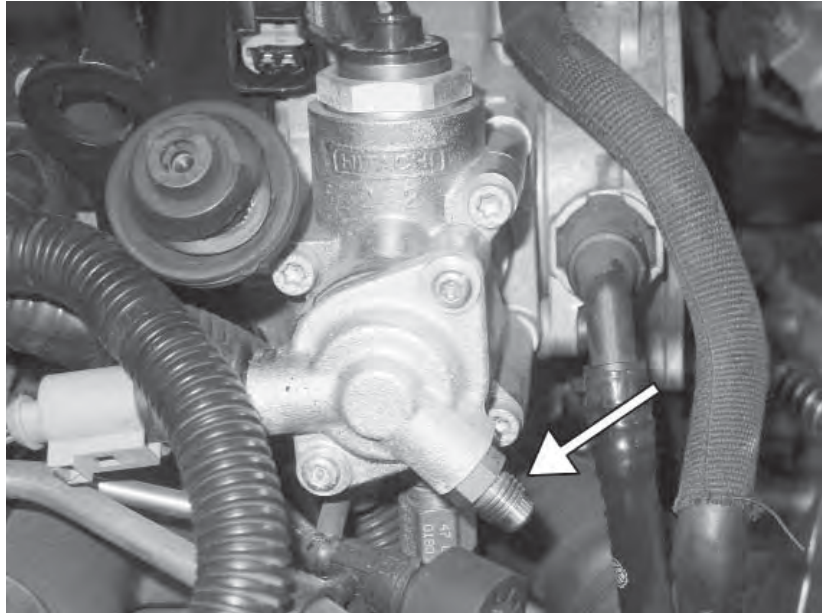

12) Remove the 8mm bolt from the radiator support, the T30 bolt, and the clip to the air noise booster pipe. Remove the noise booster hose from the car.

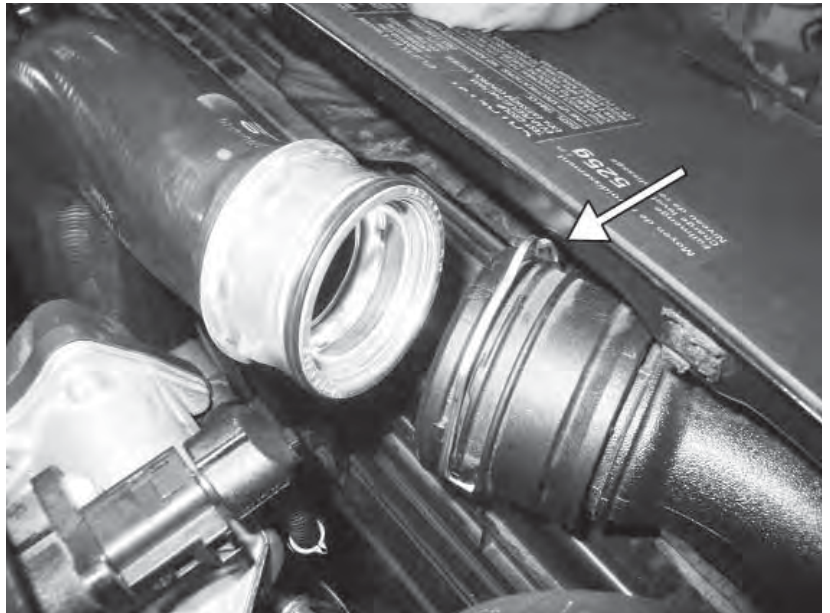

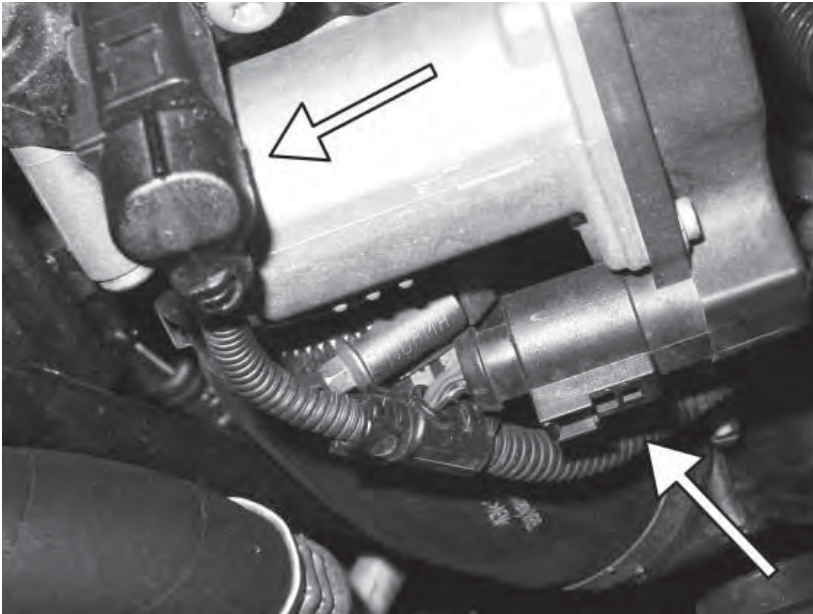

13) Disconnect the electrical connectors to the throttle body and the intake air temperature sensor.

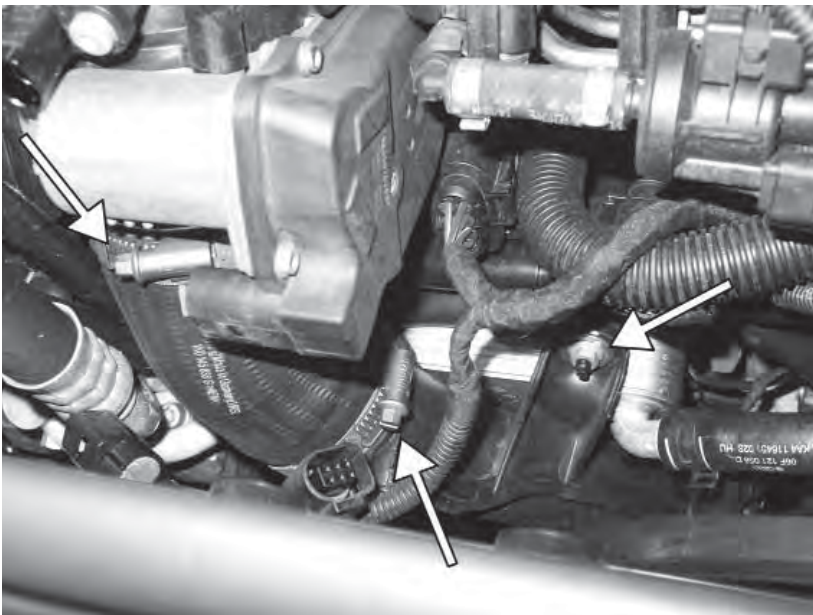

14) Loosen the rubber hose that is connected to the throttle body by removing the two hose clamps. Remove the 10mm nut from the top of the front intake charge pipe. Disconnect the electrical connector to the MAP sensor.

15) Remove the T30 bolt from the bottom of the intake charge pipe and disconnect the lower intercooler hose. Pull the front charge pipe out of the car from underneath.

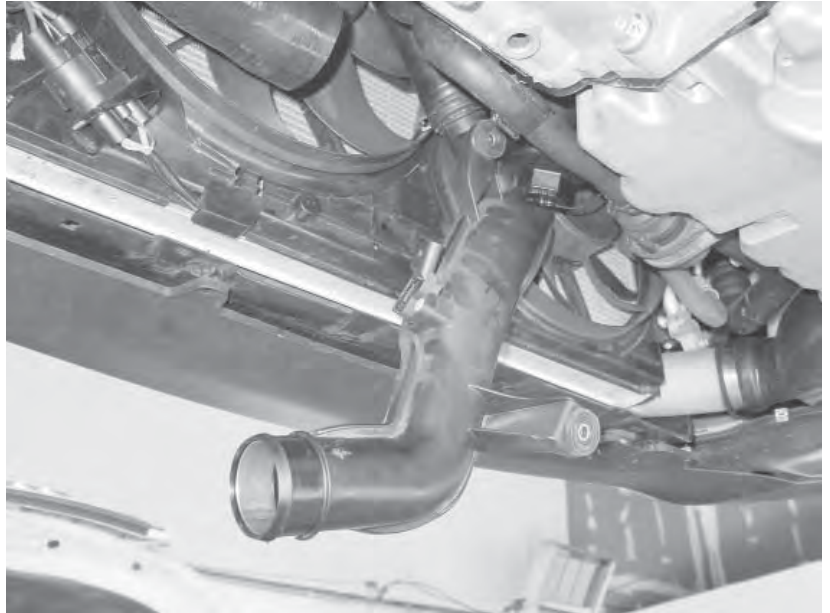

16) Remove the four T30 bolts connecting the throttle body to the intake manifold. Remove the throttle body from the car.

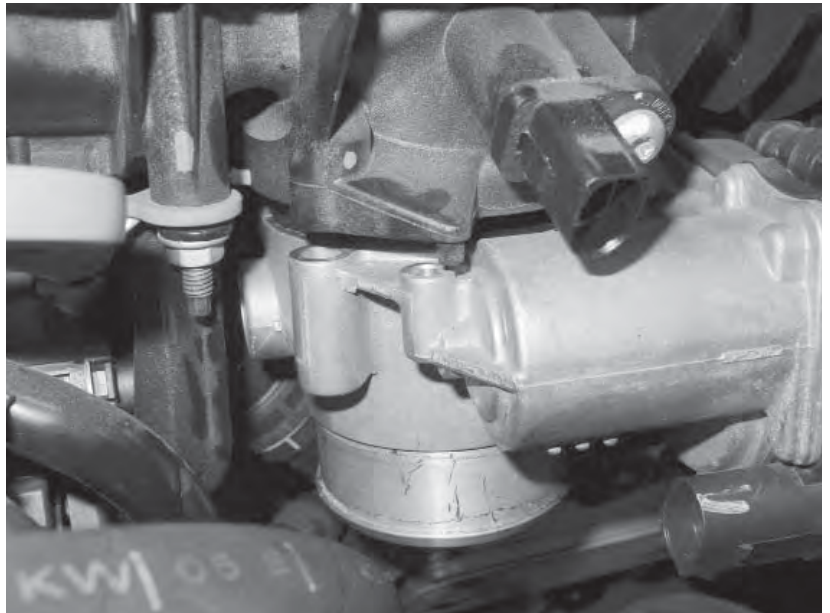

19) Remove the three rubber lines from the passenger side of the intake manifold. Note that the lines may still have some residual fuel pressure, so use a rag to avoid spillage. The line closest to the block is plastic, so be careful not to damage the line when removing the hose.

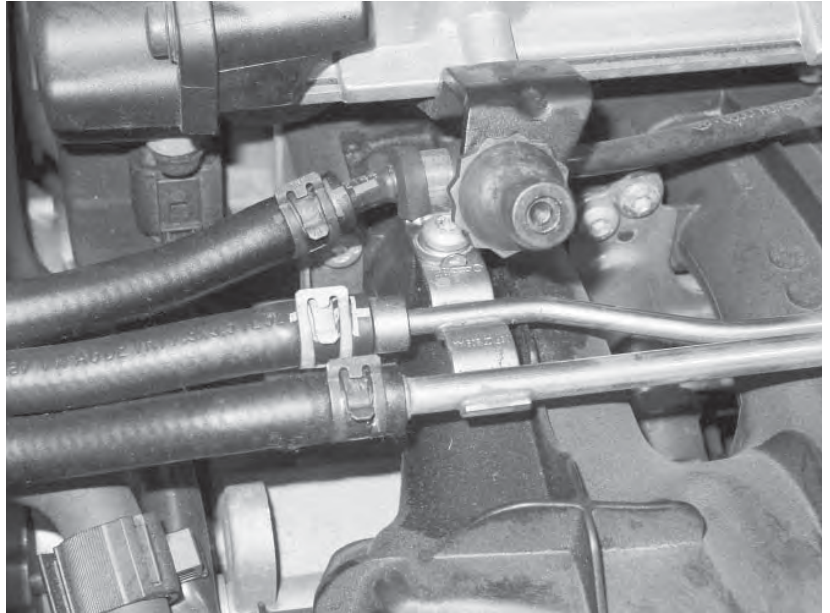

20) Remove the 10mm bolt from the passenger side of the intake manifold coolant pipe.

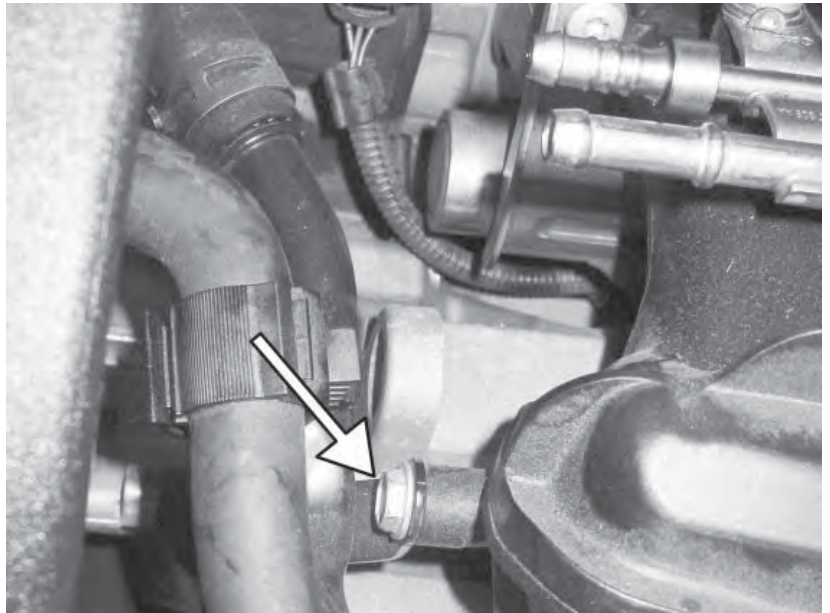

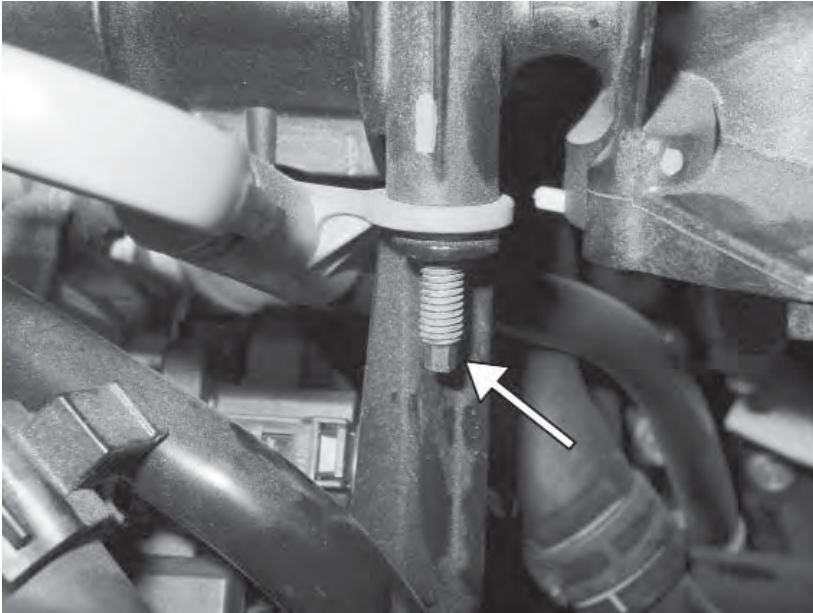

21) Disconnect the 10mm nut from the engine oil dipstick bracket. Remove the stud the nut was on using a 4mm socket.

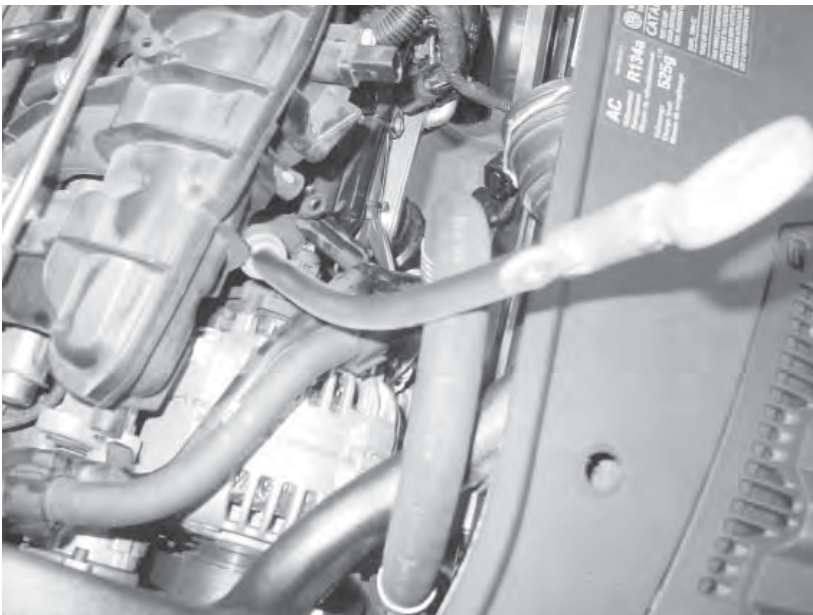

22) Remove the dipstick tube by pulling the assembly out and away from the block. Note the routing of the dipstick for later reinstallation.

23) Remove the intake manifold support bracket by removing the 13mm nut from the top of the bracket and the 10mm triple square bolt from the bottom of the bracket.

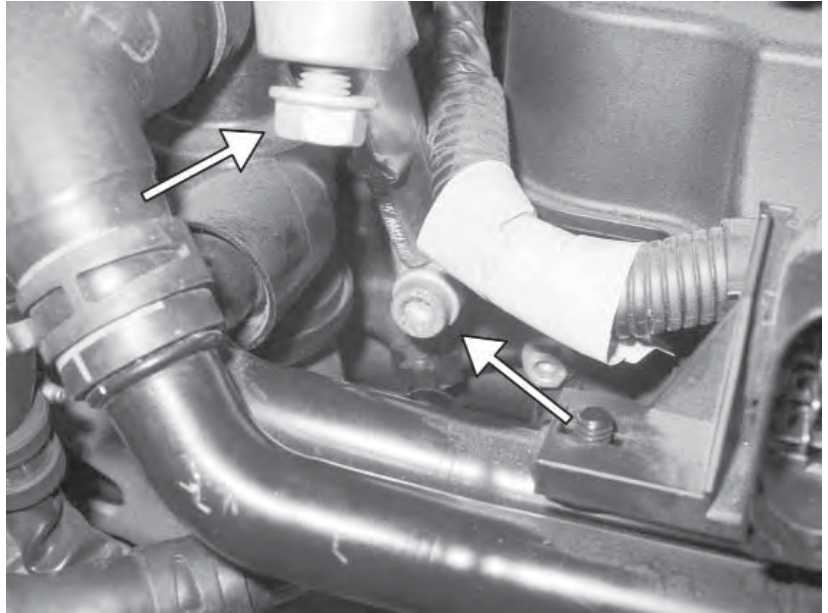

24) Remove the seven T30 bolts and two 10mm nuts from the intake manifold. Note that there are also two shorter T30 bolts between runners one and two and three and four that do not need to be removed.

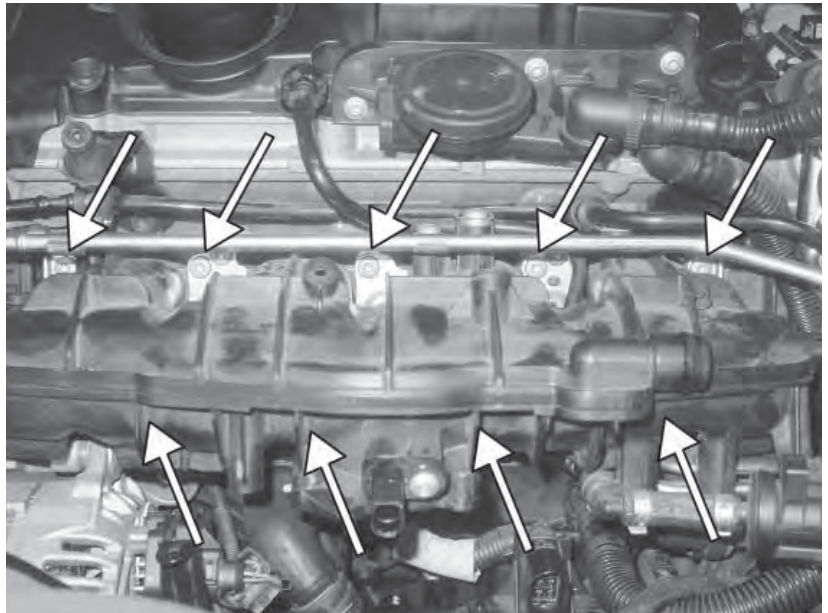

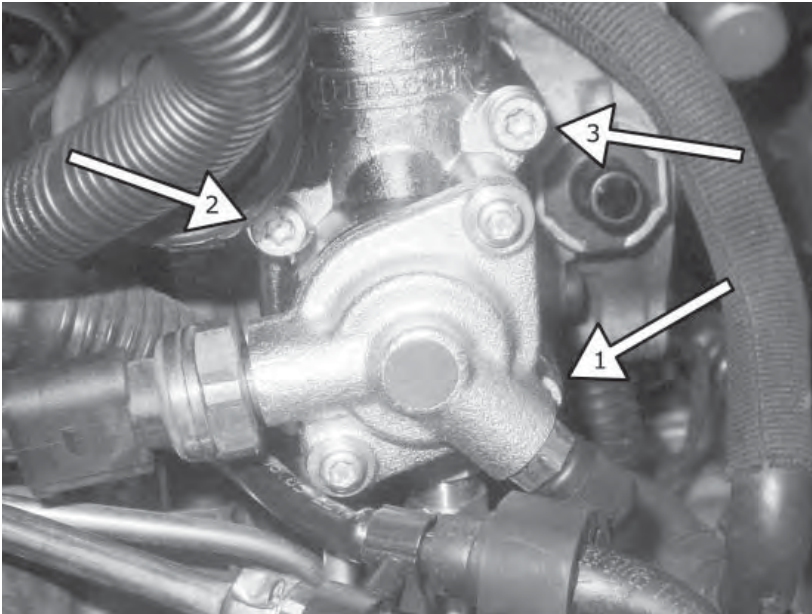

25) Remove the three T30 bolts from the fuel pump, but leave the two lower fuel lines connected.

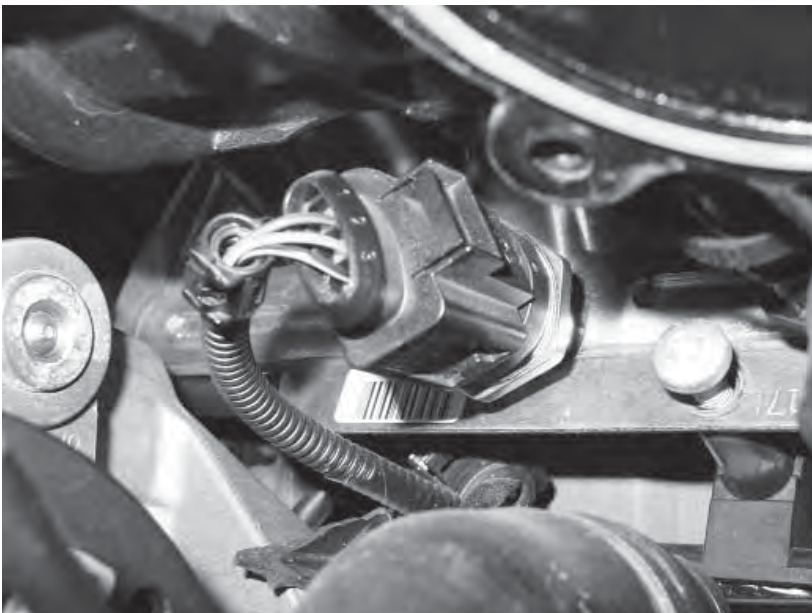

26) Gently pull the intake manifold slightly away from the block. Be careful that there is an electrical connector that must be disconnected that is under runner number two.

27) On the drivers side of the intake manifold, disconnect the wiring harness clip from the fuel line. Also disconnect the electrical connector to the variable intake runner control.

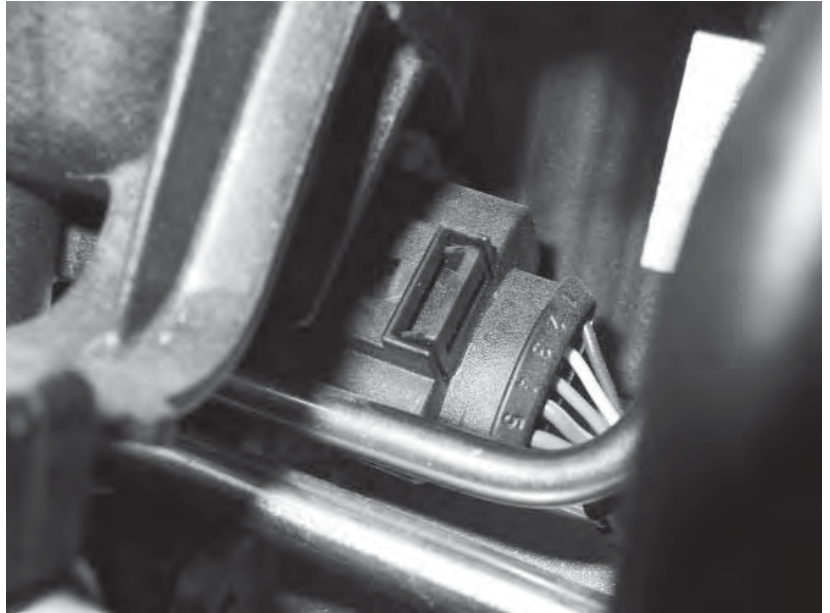

28) Carefully remove the intake manifold, making sure there are no other lines or wires that are connected. The fuel pump will come off with the manifold. Make sure that the o-rings from the stock fuel injectors are not in the intake manifold.

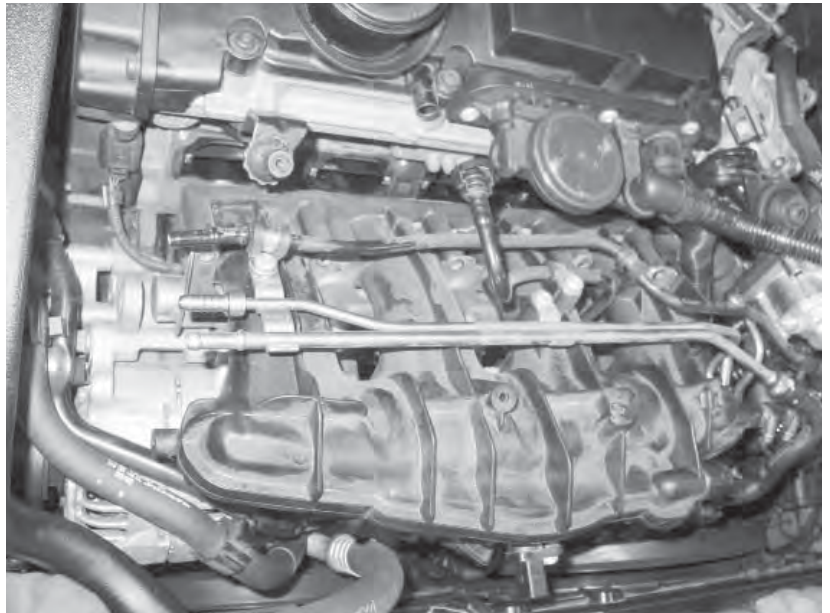

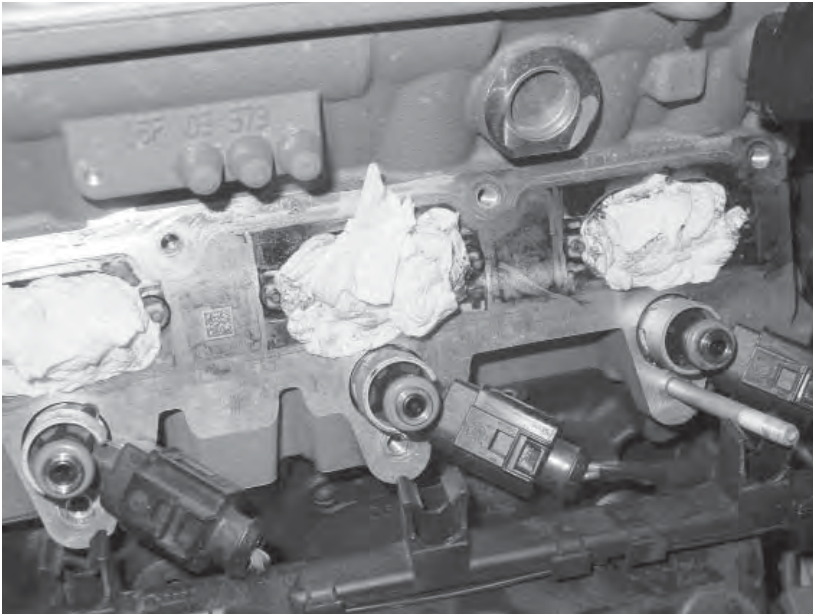

29) Put clean paper or towels in the intake ports in the cylinder head to prevent any debris from getting into the engine.

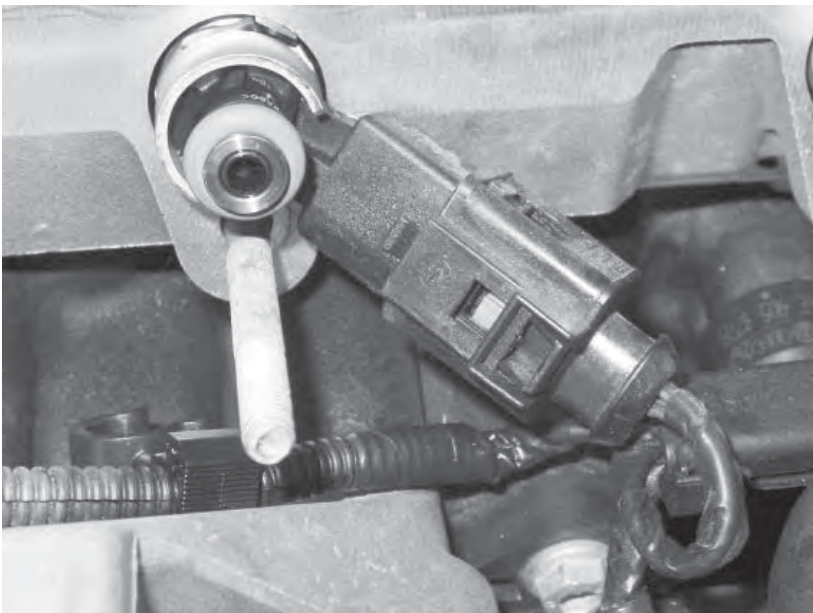

30) Disconnect the fuel injector wiring harness, and pull out of the way.

31) Break the eight plastic tabs on the fuel injector clips (one on the top, one on the bottom). Some cars may have metal clips, so just bend the clips out of the way. Remove the outer metal sleeve from the injector seals.

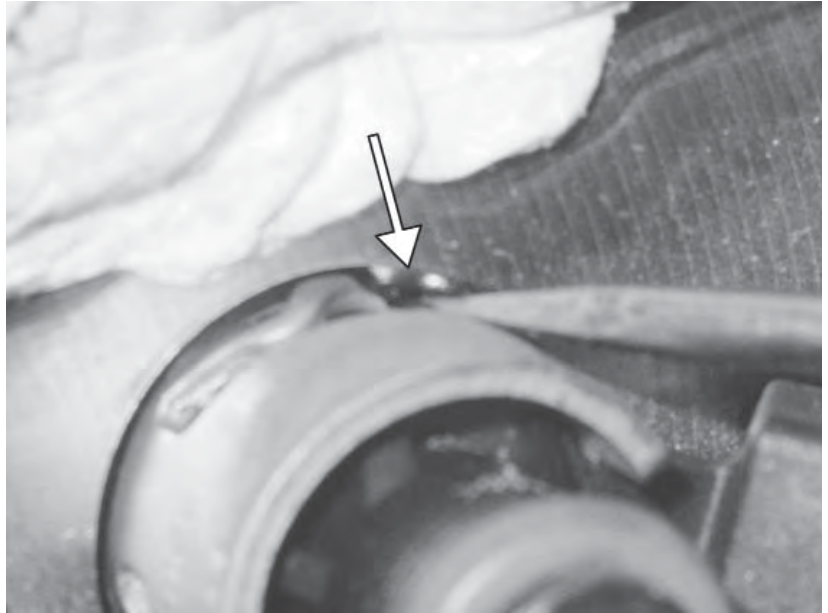

32) Pull the injectors out of the engine block. Be sure to remove the remainder of the clips that you broke earlier that may still be inside the block.





33) Preassemble the APR injectors with the new, supplied injector clips. The gaskets included in the installation kit are not needed with the new APR injectors.

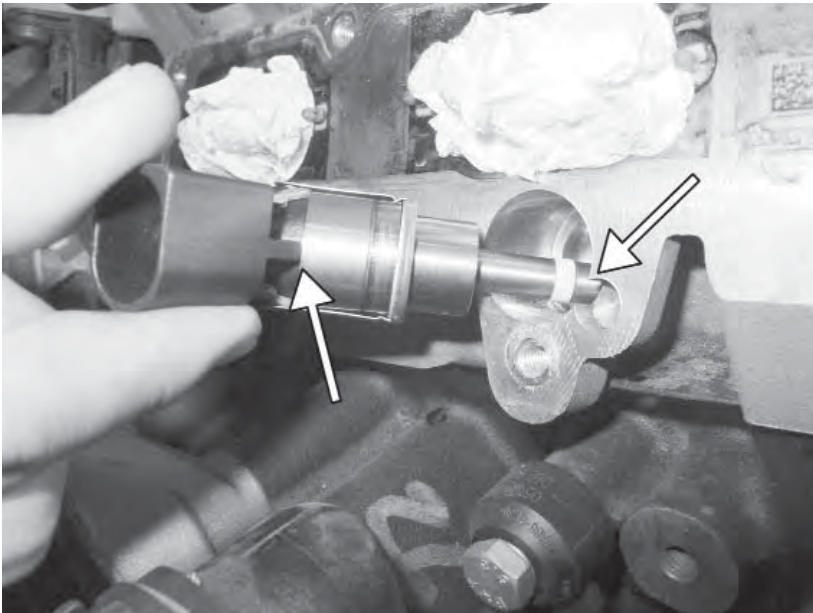

34) Push the APR injectors into the intake manifold. Make sure the lip on the back of the wiring connector of the injector slides into the slots of the block. This must be aligned in order for the injector to fully seat in the block correctly.

35) Depending on the existing connections on the car, you may need to remove the barbed fuel line fitting from the APR fuel pump and the corresponding fitting from your stock pump. Install the fitting from your old pump into the same spot on the APR pump.

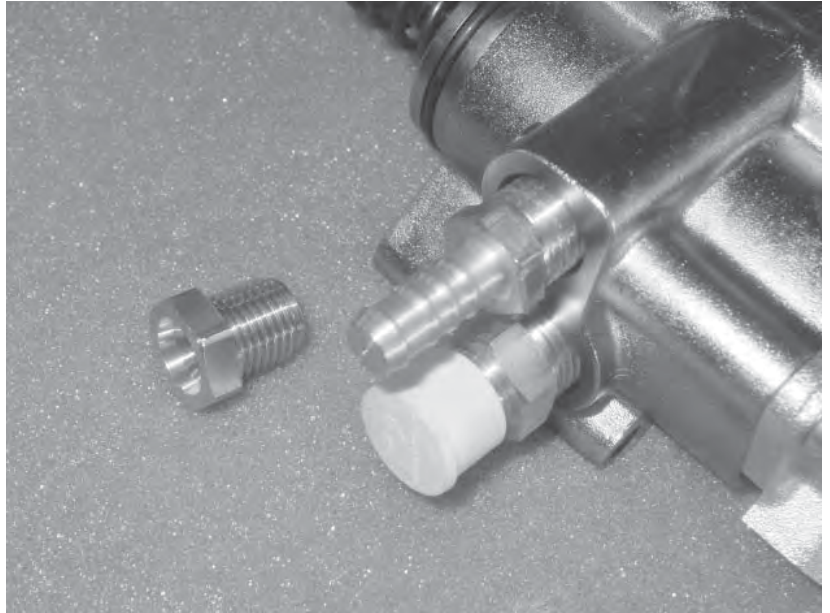

36) Disconnect the fuel lines from the factory fuel pump using an 8mm triple square and 17mm flare wrenches. Replace the stock pump with the APR pump and tighten the fuel line fittings. Make sure to use two wrenches to hold both sides of the line while you tighten the fittings.

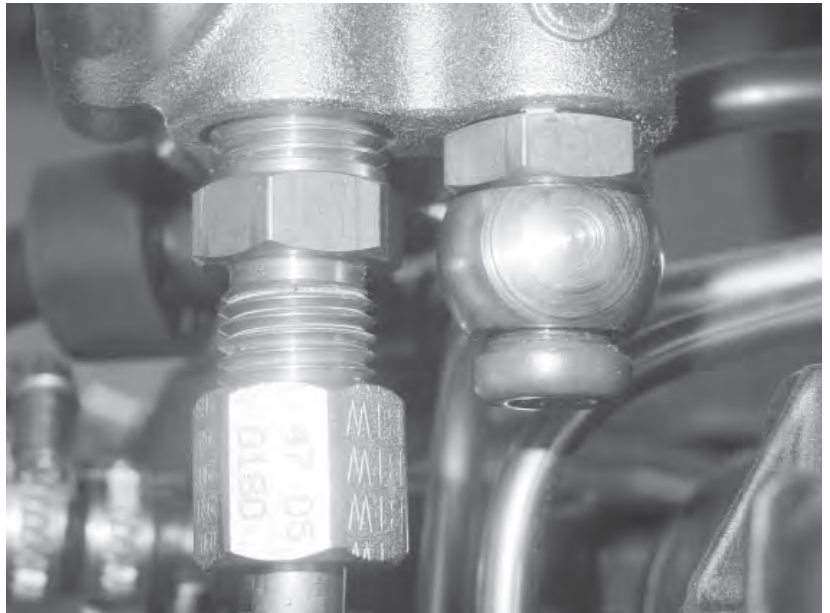

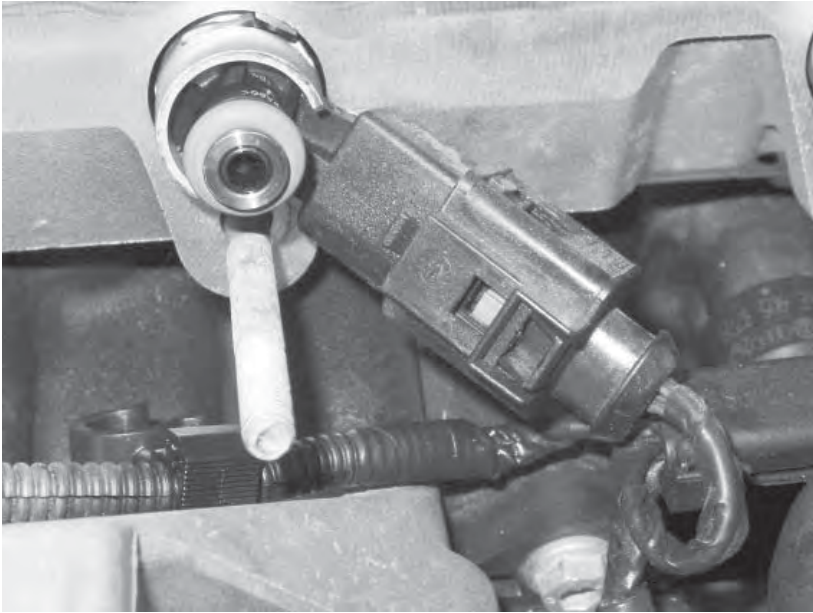

37) Reconnect the fuel injector wiring harness and set it back in its original location.



38) Remove the paper or cloth from the intake ports on the block, being careful not to pull the flow separators out of the block.

39) Before reinstalling the intake manifold and fuel pump assembly, inspect the fuel pump cam follower and cam lobe for wear. Reinstall the intake manifold and fuel pump assembly. Make sure to align the fuel pump in its correct position on the cam housing. Also verify that all lines and wires are clear from the manifold before sliding the manifold all the way onto the block.

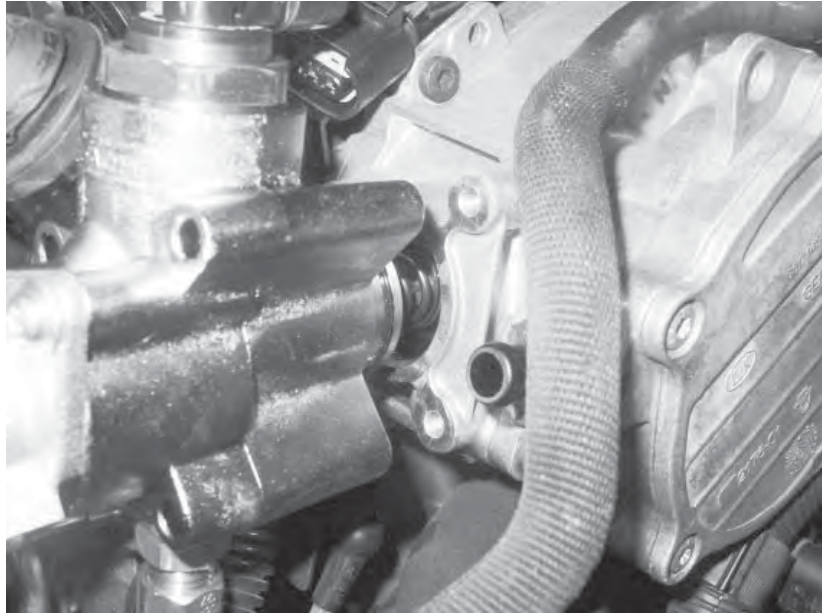

40) Reinstall the three T30 bolts that connect the fuel pump to the cam housing. Tighten these bolts to 89in-lbs in the following sequence: bottom right, top left, top right.

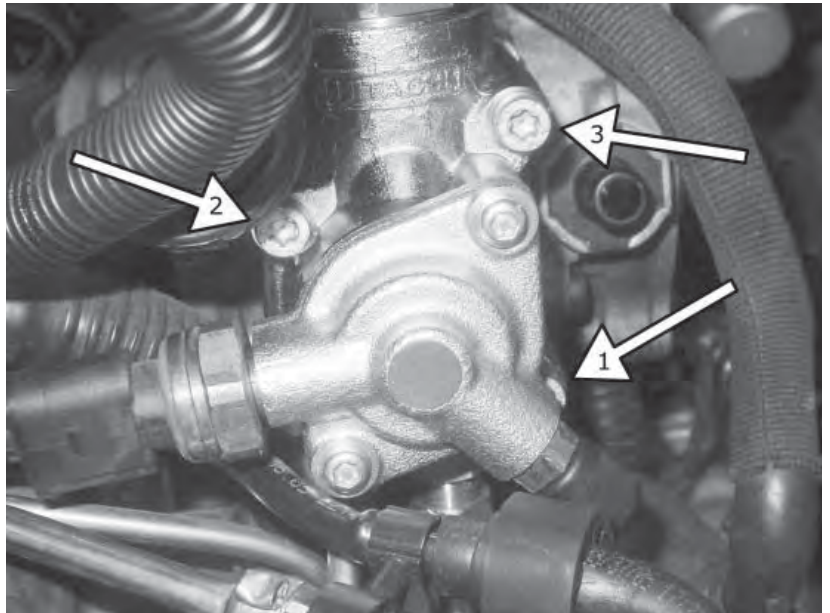

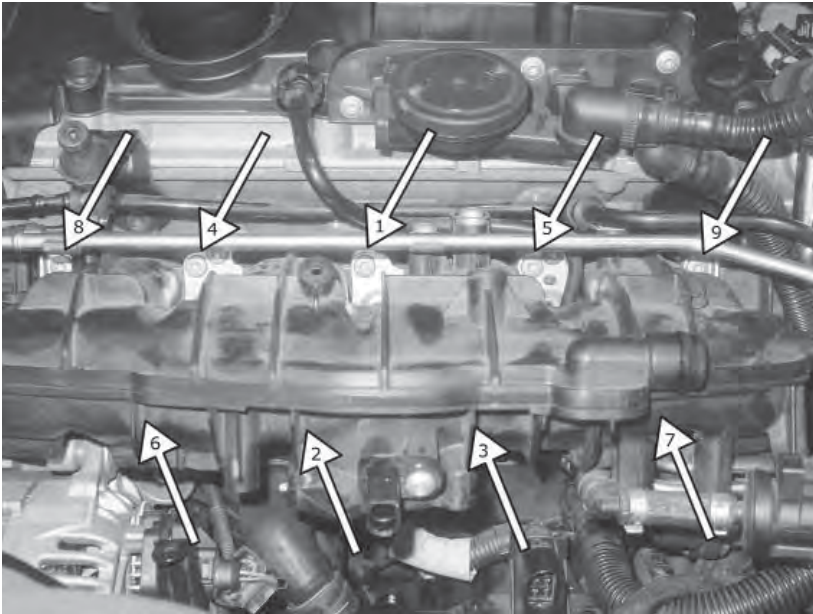

41) Reinstall the seven T30 bolts and two 10mm nuts that connect the intake manifold to the cylinder head. Tighten the nuts and bolts to 89in-lbs, working from the center fasteners to the outside ones in a crossing pattern.

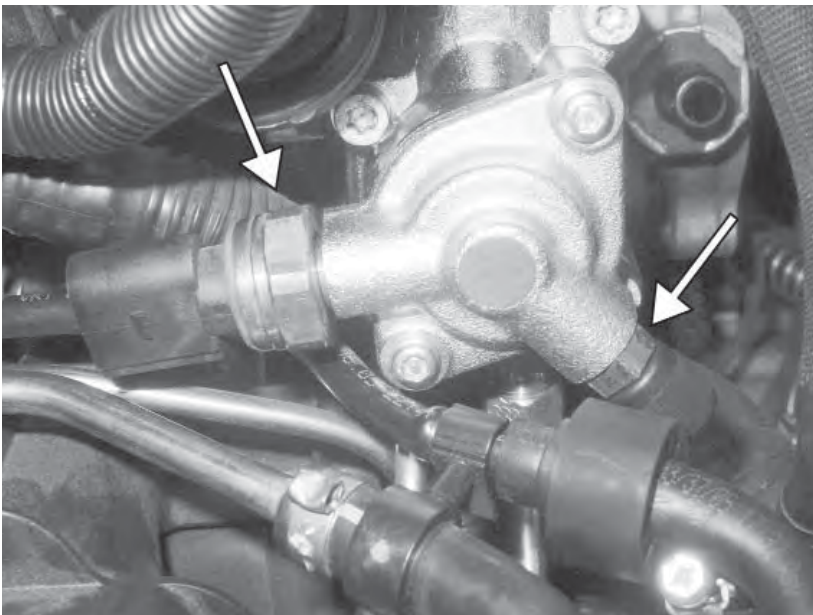

42) Remove the fuel pressure sensor from the stock fuel pump, and install it on the APR pump with a 24mm closed end wrench. Reinstall the pressure release valve that was previously removed from the stock fuel pump with a 13mm closed end wrench.

43) Reinstall the dipstick tube into the engine block, and orient the bracket the way it was before.

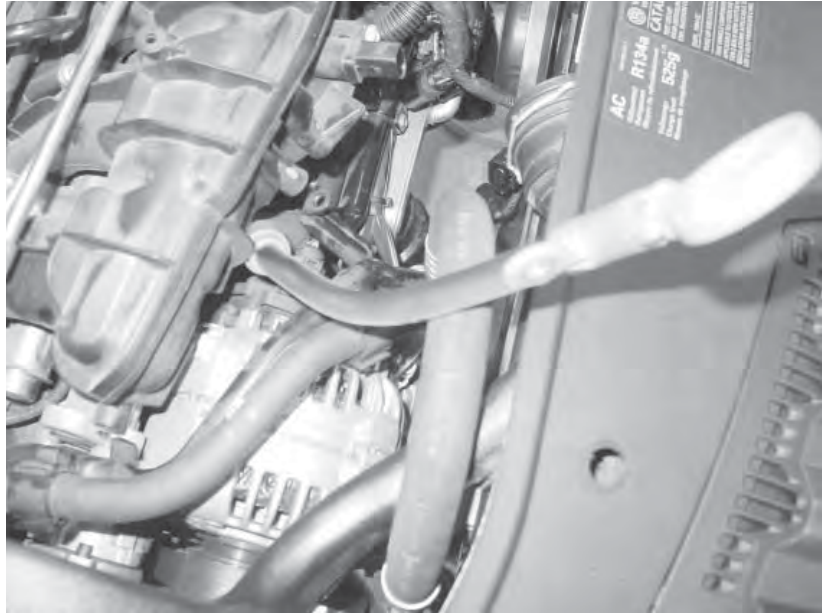

44) Connect the following electrical connectors on the intake manifold: plug under the intake manifold by the alternator, connector on drivers side of intake manifold and clip, EVAP purge valve, fuel pressure sensor, fuel pressure regulator, and fuel injector wiring harness.

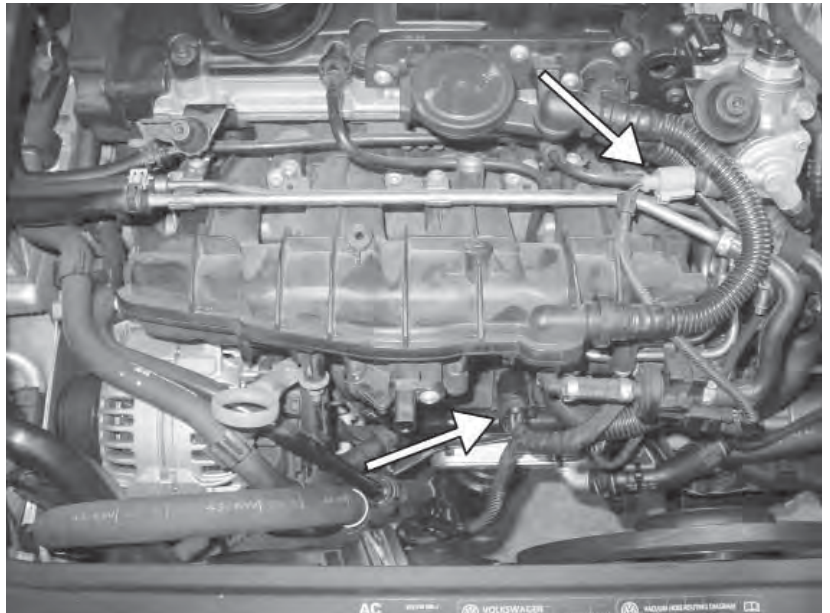

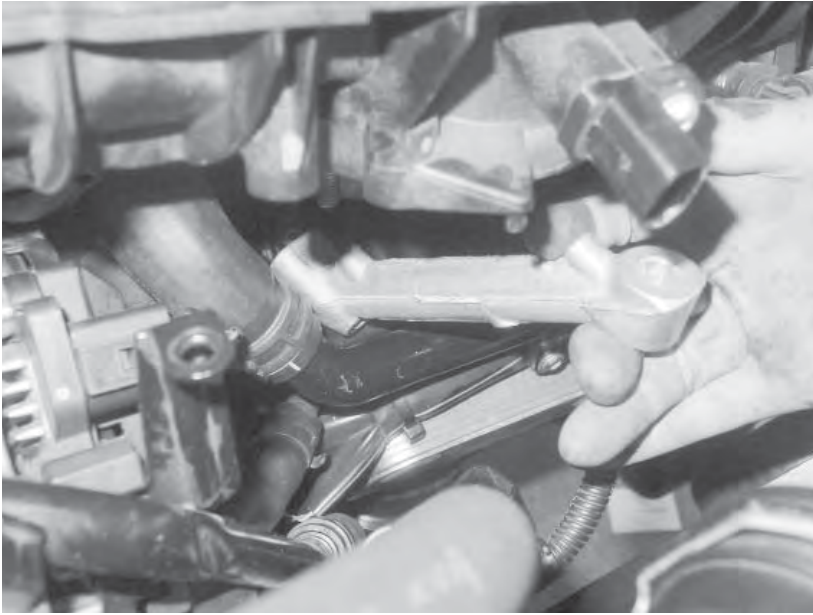

45) Reinstall the intake manifold support bracket with the 13mm nut and the 10mm triple square bolt.

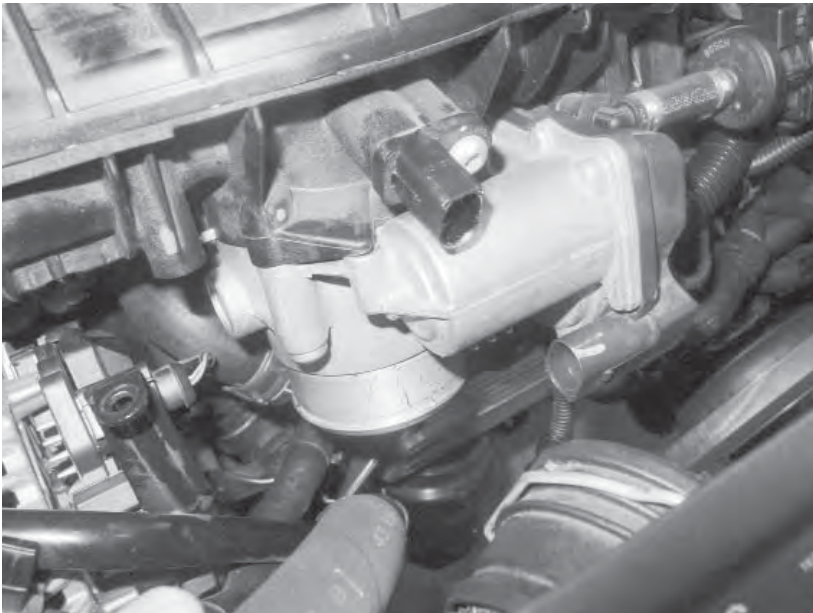

46) Set the throttle body back in place on the intake manifold and torque the T30 bolts to 89in-lbs in a crossing pattern.

47) Reinstall the rubber boot to the throttle body, but do not tighten the clamp.

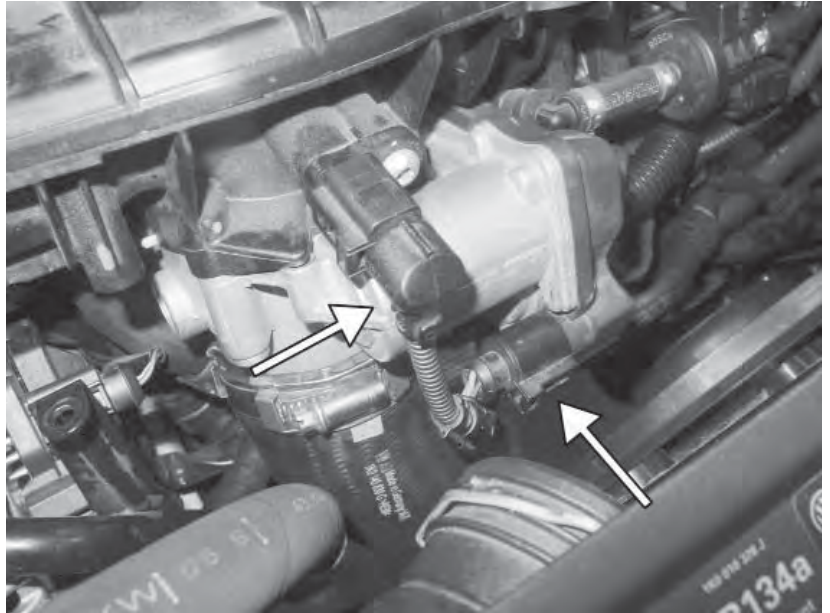

48) With the coolant line bracket and the dipstick tube properly aligned, reinstall the stud with a 4mm socket. Reinstall the 10mm nut holding the dipstick tube to the stud. Also reinstall the 10mm bolt that holds the coolant line to the side of the intake manifold.

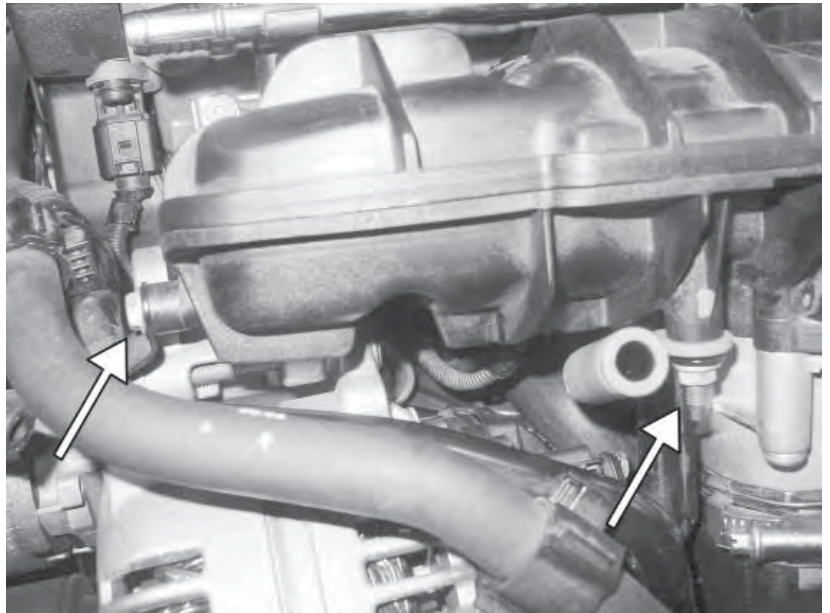

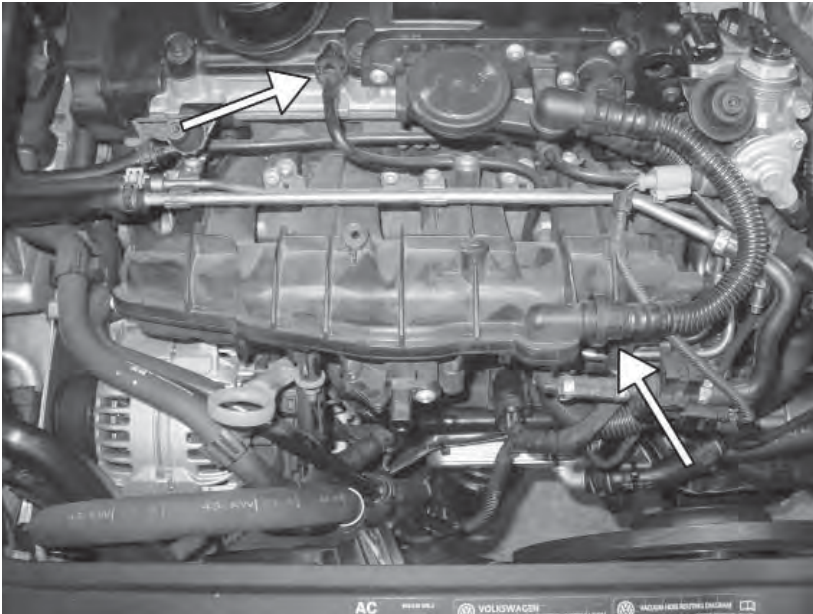

49) Reconnect the two breather tubes to the valve cover. Push to lock in place.

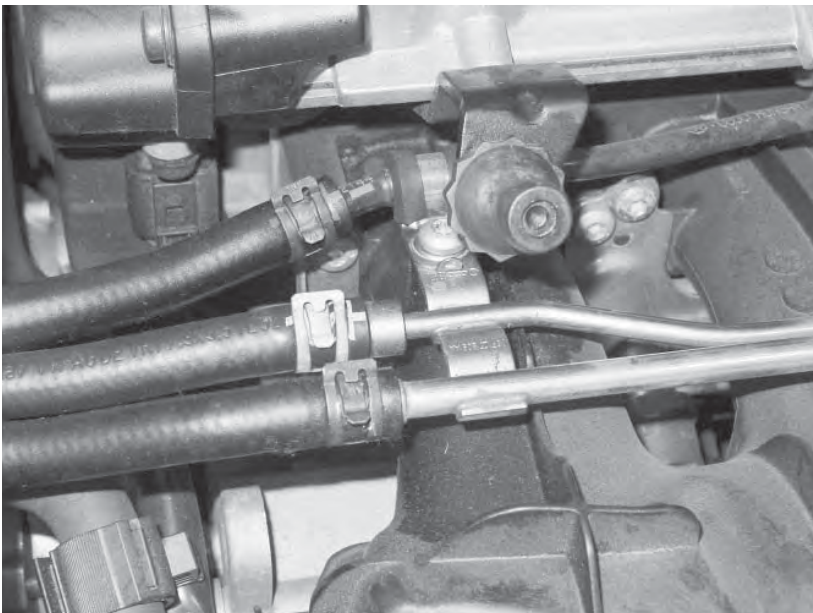

50) Reconnect the three rubber lines on the passenger side of the intake manifold. Make sure the lines are oriented correctly.

51) From underneath the car, reinstall the front plastic intake charge pipe. Connect all hoses and make sure the orientation is correct. Loosely reinstall the T30 bolt on the bottom bracket of the charge pipe. From above, reinstall the 10mm nut.

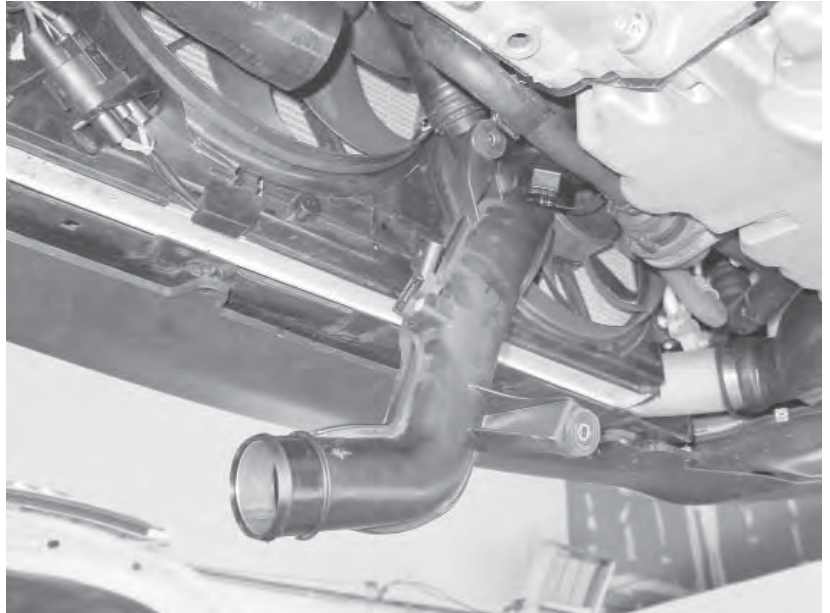

52) Reconnect the lower intercooler hose to the intake charge pipe and tighten the hose clamp. Also tighten both hose clamps to the rubber boot off of the throttle body.

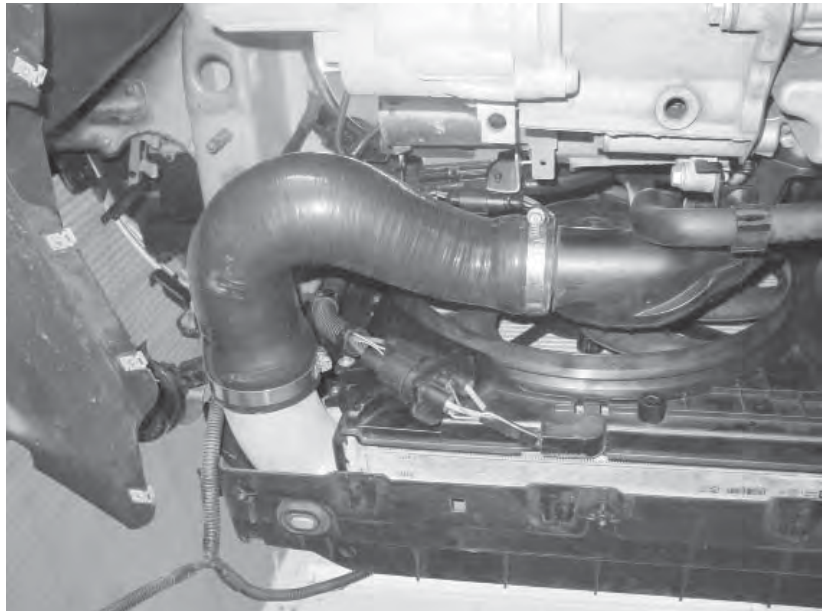

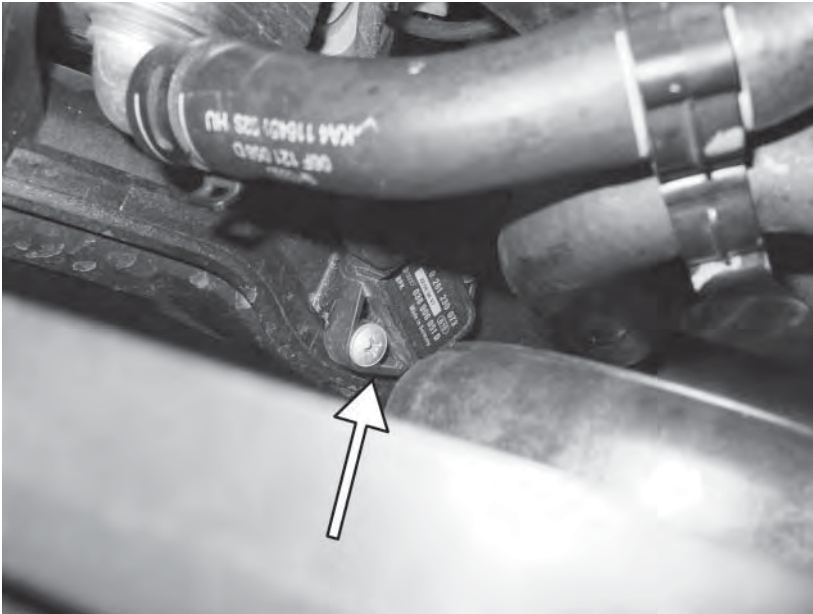

53) Reconnect the electrical connector to the MAP sensor.

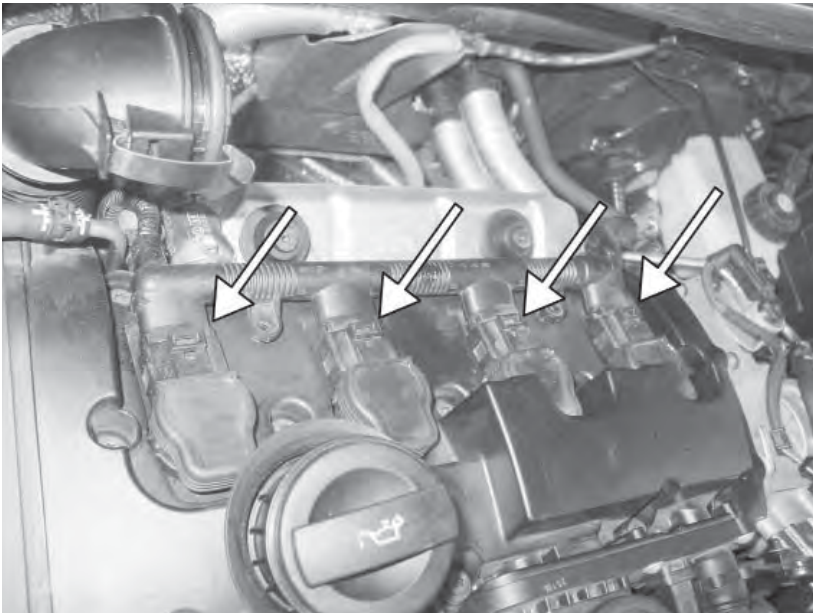

54) Disconnect the four connectors on the factory coil pack wiring harness.

55) Disconnect the primary oxygen sensor electrical connector and remove the wiring harness from its clips.

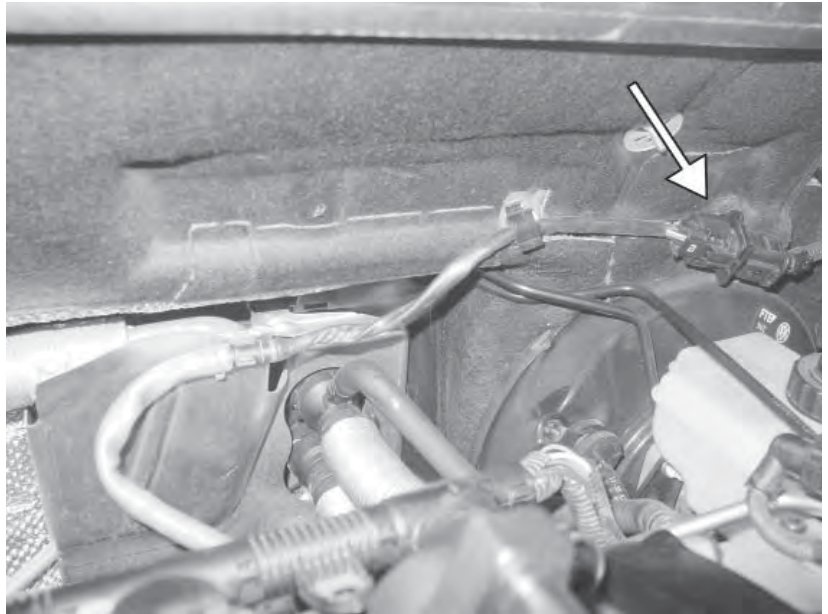

56) Drain the engine coolant by removing the quick disconnect coupling on the lower coolant line off of the passenger side of the radiator. Remove the coolant reservoir cap to aid in draining. Once the coolant is drained, reconnect the coolant line to the radiator and make sure it is secure.

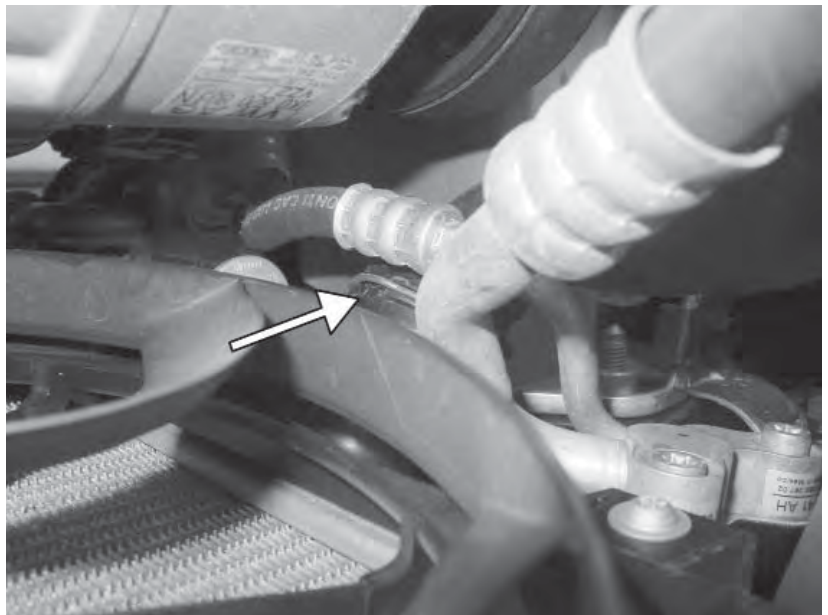



57) Flip up the bottom of the rear seat, but do not remove it. Under a carpet flap, you will see the access to the fuel pump. Disconnect the electrical connector on the plastic cover, and then pry the cover off carefully.



58) Disconnect the electrical connection from the pump housing. Also disconnect the two bundy connectors from the fuel fill and vent lines.

59) Using a hammer and chisel, gently remove the metal ring holding the fuel pump housing in place. The ring needs to be rotated counterclockwise.



60) Lift the fuel pump housing out of the tank, being careful not to spill gas and not bending the fuel level float. Disassemble the housing and replace the fuel pump with the APR pump. Reinstall the fuel pump, reversing the order it was removed.



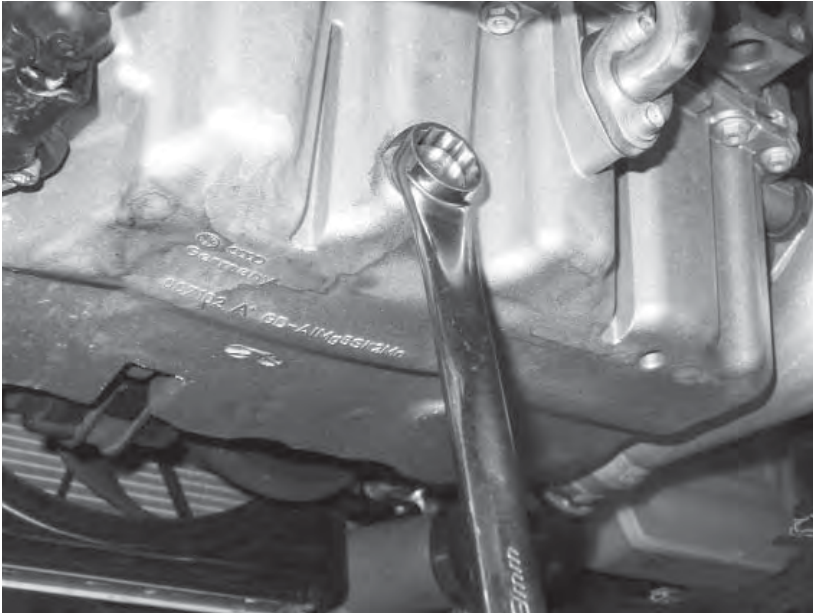

61) Drain the engine oil by removing the 18mm drain bolt from the bottom of the oil pan. It is advisable to change the oil filter on the car at this time as well.



62) Remove the front passenger wheel and set aside.

63) Remove the belly pan and lower portion of both front wheel wells.

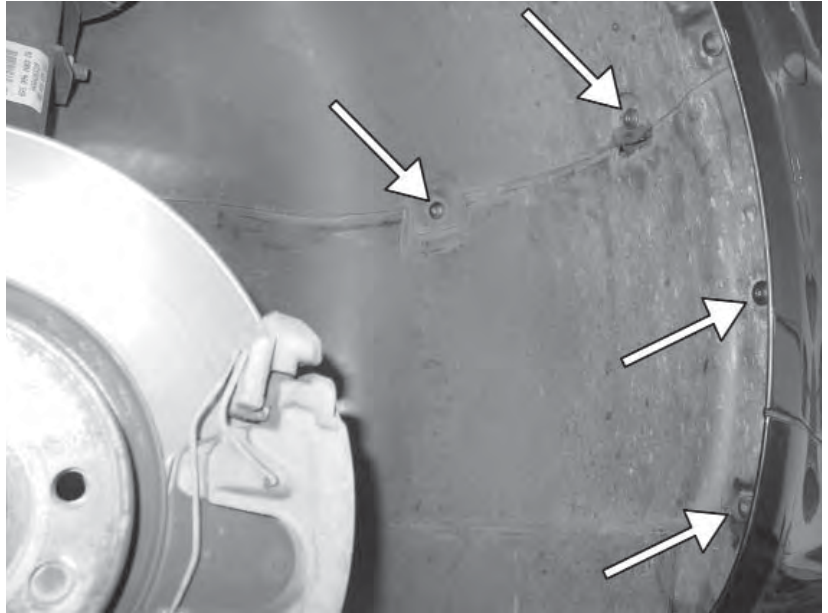

64) Remove the 27mm axle bolt from the passenger axle.

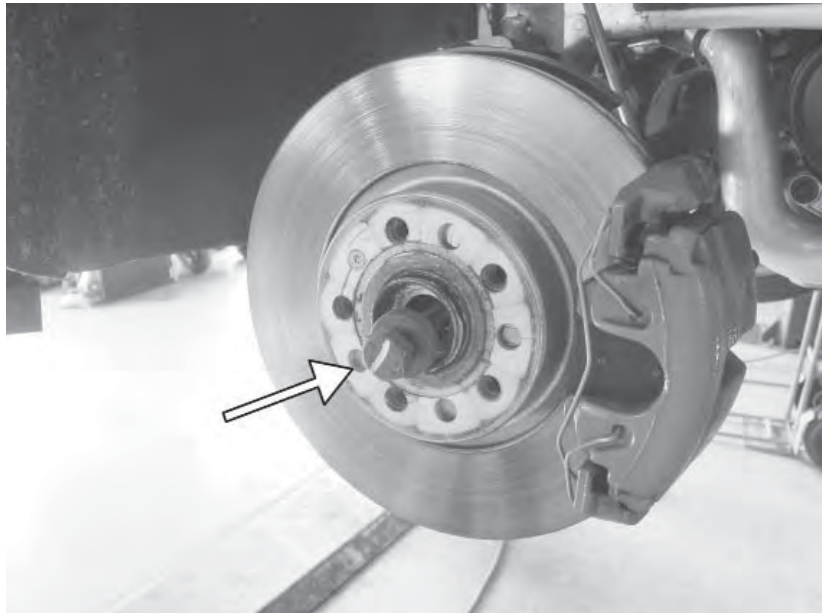

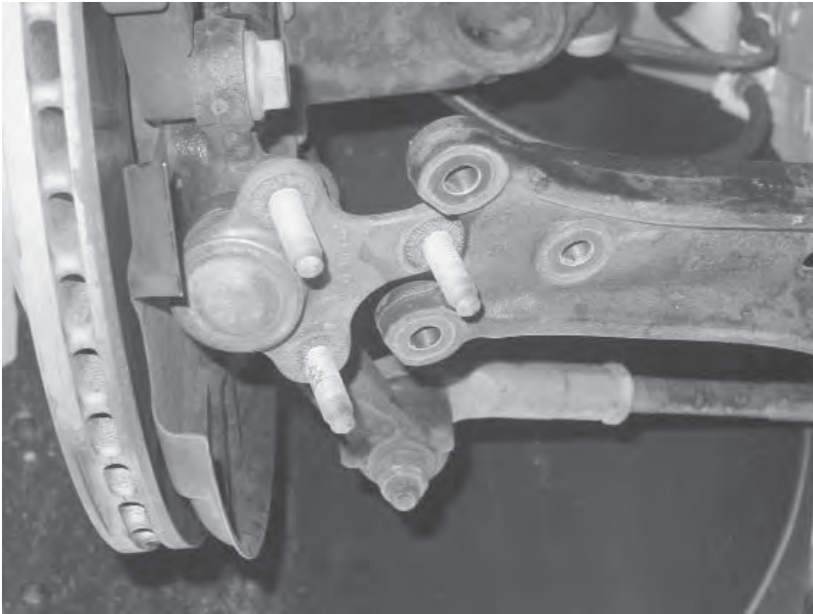

65) Remove the three lower 16mm nuts from the lower ball joint on the lower passenger control arm.

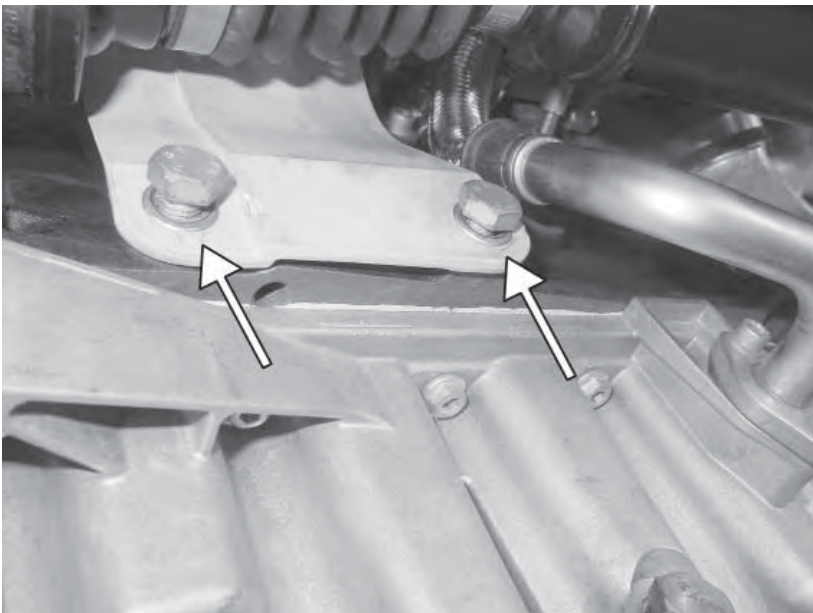

66) Remove the two 16mm bolts from the inner axle heat shield, and remove the shield from the car

67) Remove the primary oxygen sensor with an oxygen sensor socket. Take care to not get grease/oil/water on the sensor element.

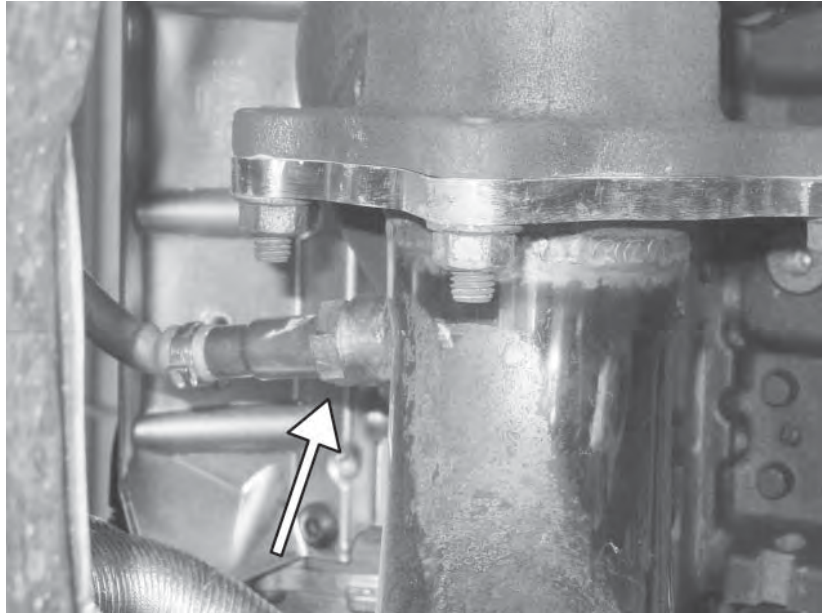

68) Remove the downpipe portion of the exhaust by removing the four 16mm nuts from the turbocharger. Disconnect the downpipe portion of the exhaust from the catback and remove from the car.

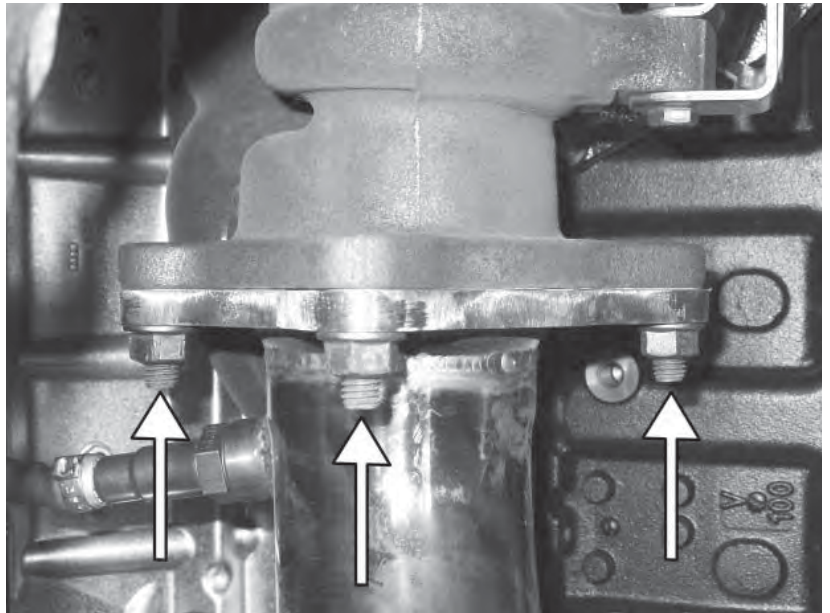

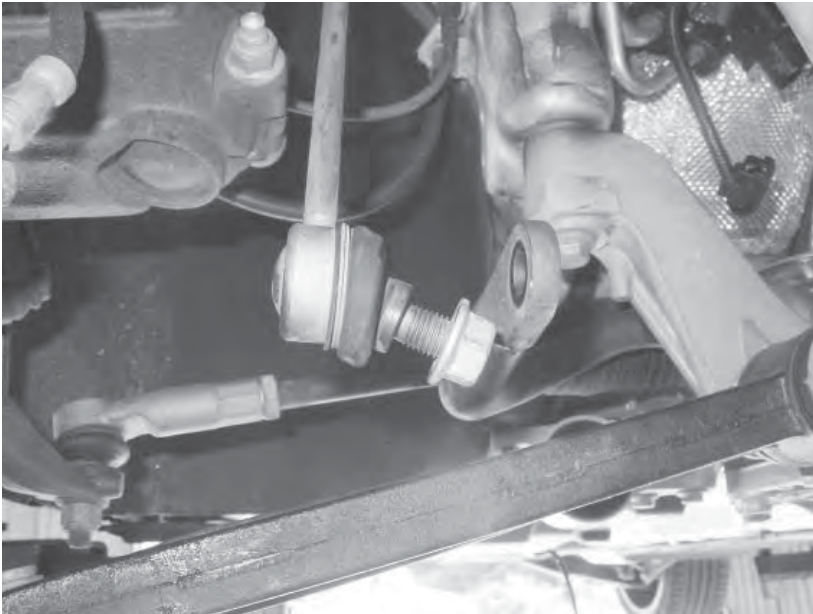

69) Disconnect the 18mm nut from the passenger side sway bar end link and separate the link.

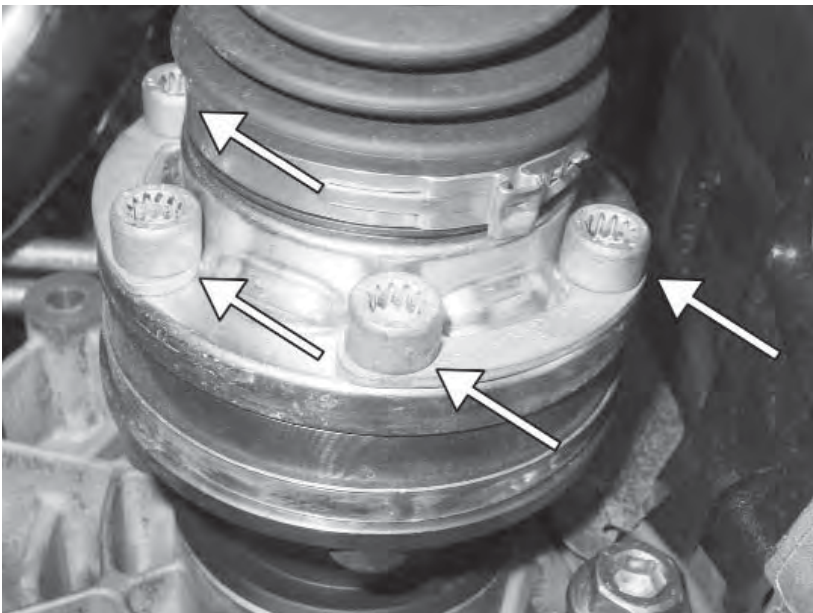

70) Using a 10mm triple square, remove the six inner axle bolts from the passenger side axle. Keep the axle bolts and bolt straps together. Remove the axle from the car.

71) Remove the 5mm allen bolts from the stock turbocharger oil drain line to the engine oil pan, and from the bottom of the turbocharger.

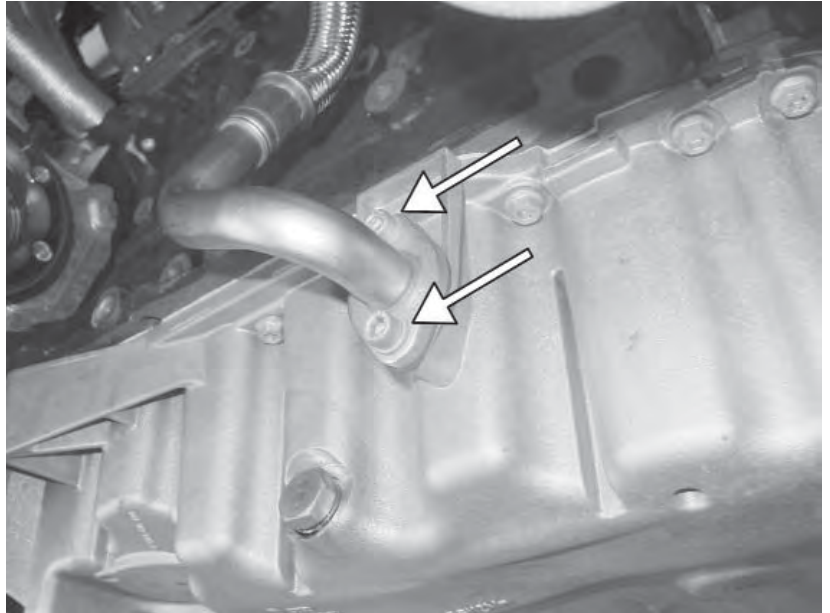

72) Remove the passenger side metal pressure pipe. Pull the clip from the lower intercooler hose coupler and disconnect the coupler. Also disconnect the coupler on the connection to the stock turbocharger. Remove the two T30 bolts from the pressure pipe and remove from the car.

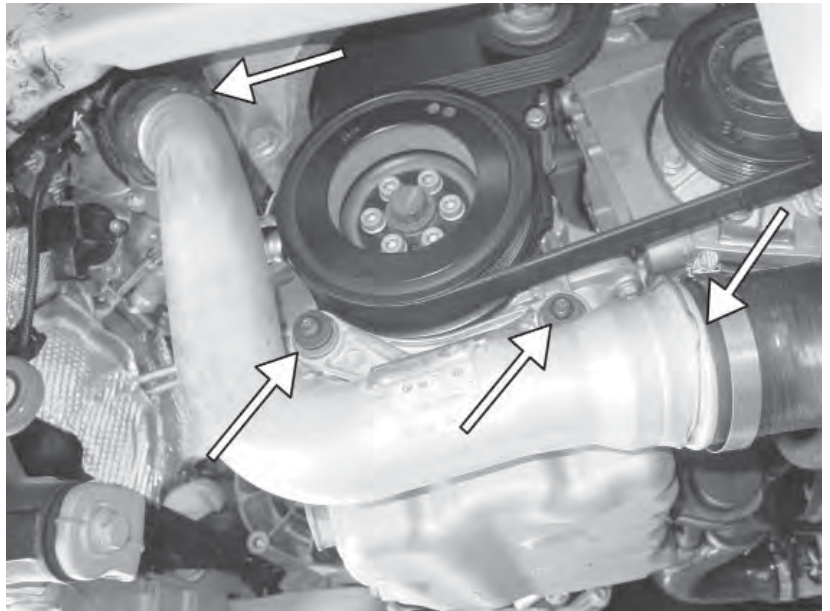

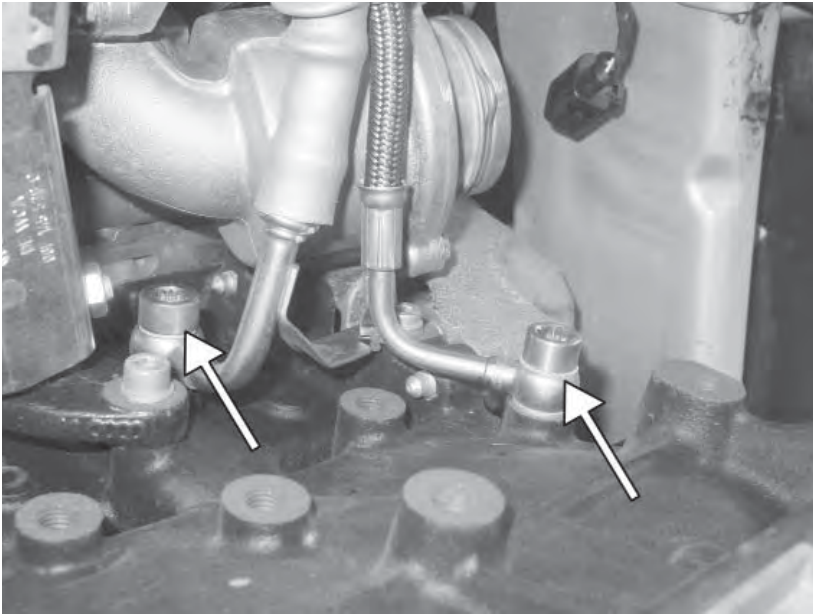

73) Remove the turbocharger coolant and oil feed lines from the back of the engine block with a 12mm triple square.

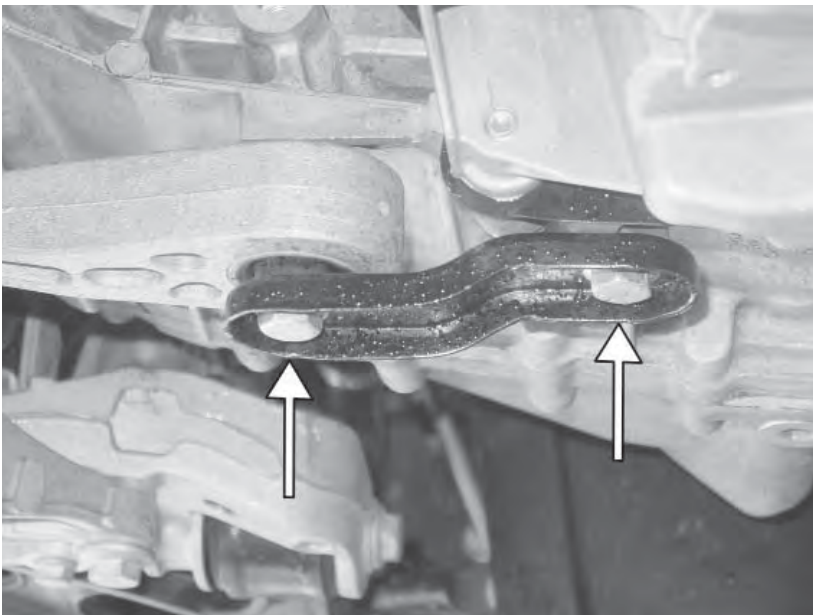

74) Disconnect the transmission dogbone mount from the engine by taking off the two front 16mm bolts.

75) Remove the two 6mm allen bolts that connect the turbo support bracket to the engine block. Also remove the two 13mm bolts from the bracket and remove the bracket assembly.

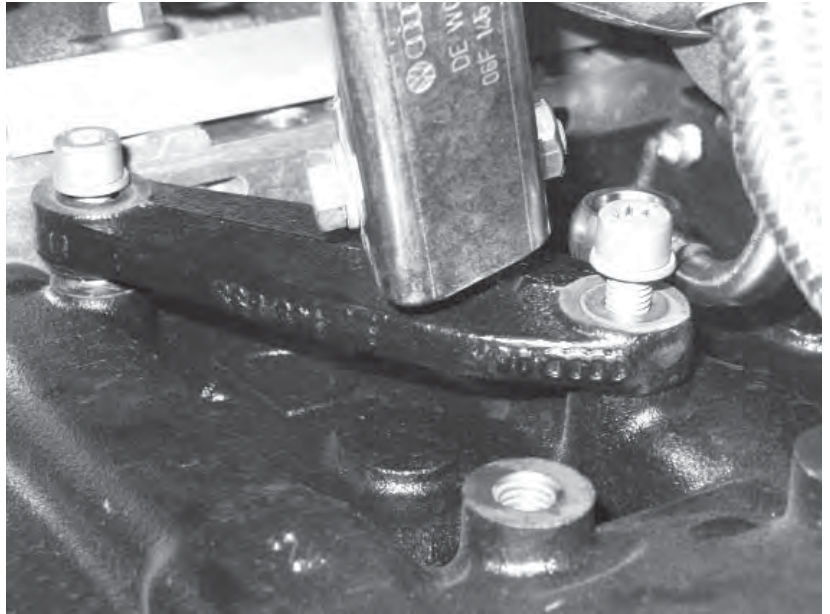

76) Disconnect the N75 and diverter valve electrical connectors.

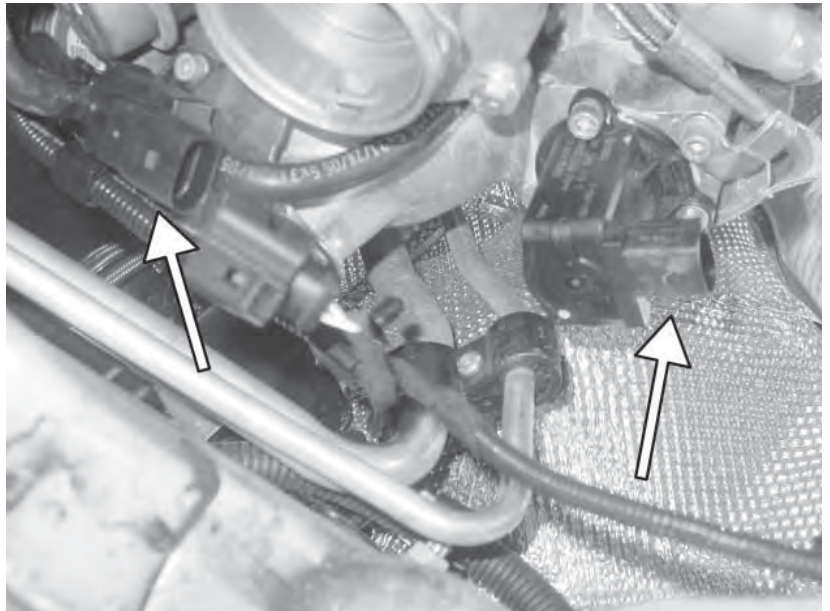

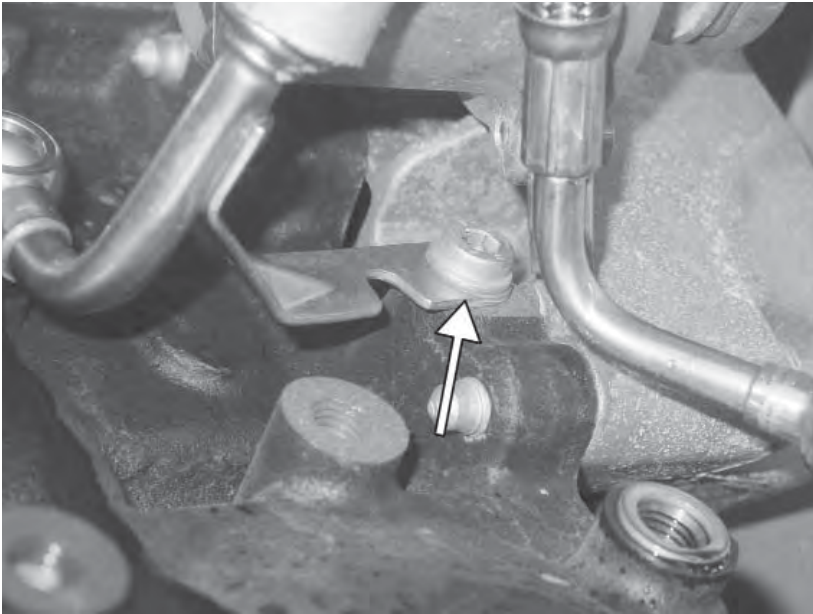

77) Loosen the 6mm allen bolt that connects to the oil line, but do not remove it.



78) Remove the two rubber lines from the back side of the valve cover.

79) Remove the stock plastic accordion compressor inlet hose by loosening the hose clamp.



80) Remove the two 24mm plastic grommets that connect the stock airbox to the turbocharger heat shield. Also remove the four 10mm nuts on the back side of the heat shield, as seen from the back of the engine.

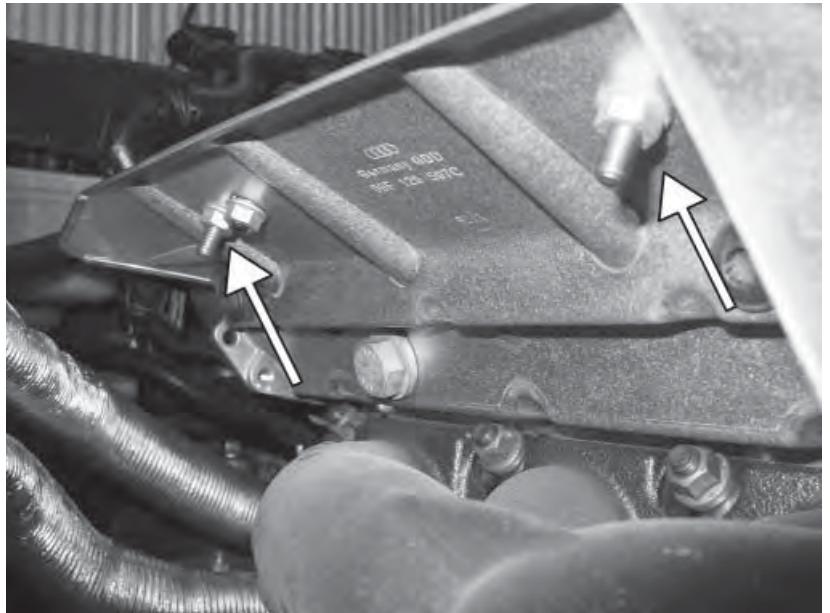

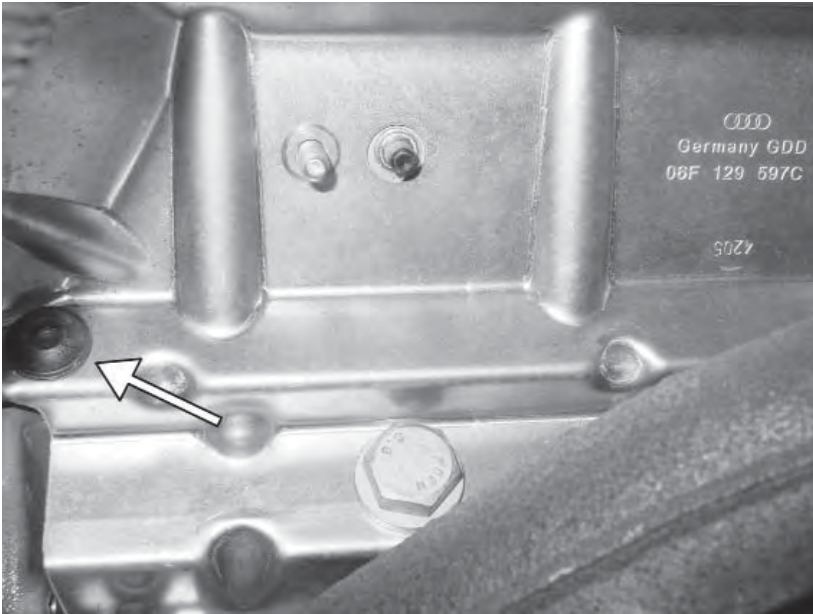

81) Remove the two 8mm triple square bolts that connect the turbocharger heat shield to the cylinder head.

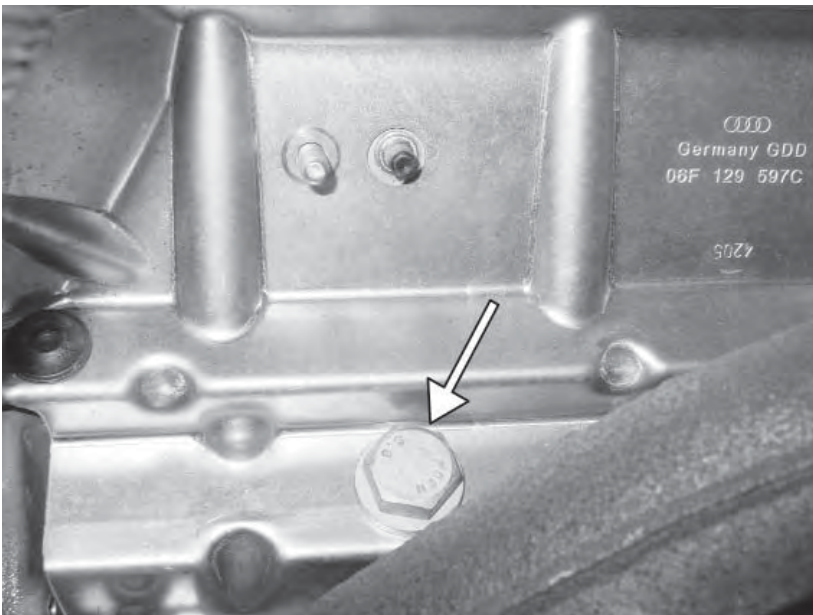

82) Remove the two 18mm bolts from the turbocharger heat shield and remove the shield.

83) Remove the five upper 12mm nuts on the stock exhaust manifold. Loosen the lower nuts 3-4 turns, but do not remove. Once the manifold/turbo assembly is loose, remove the previously loosened 6mm allen bolt that connects the lower oil line bracket.

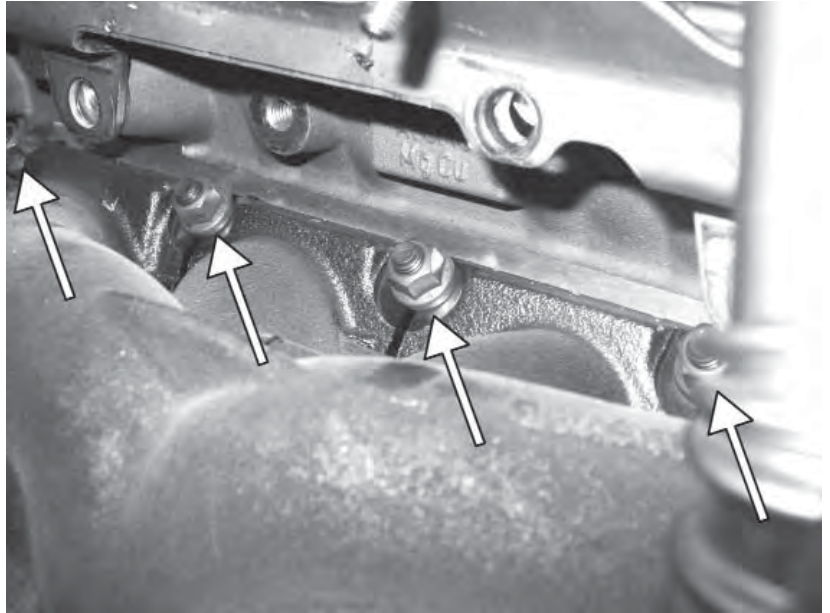

84) With the stock manifold/turbo assembly moved away from the block, cut the remaining coolant line leaving as much rubber as possible. The rubber portion of this line will be reused.

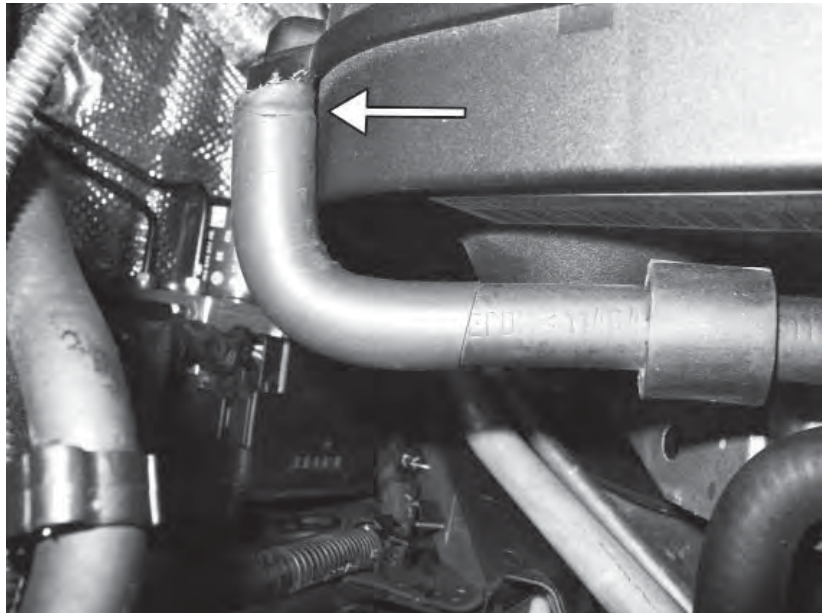

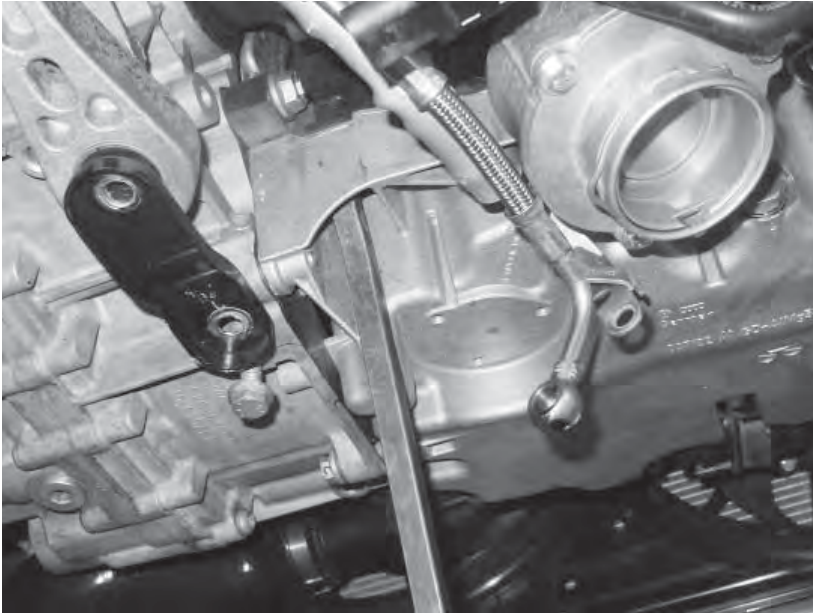

85) With a partner prying the engine forward, lower the turbo/manifold assembly and remove from between the block and subframe.



86) On a clean workbench, lay out the APR exhaust manifold, turbocharger, and turbo to manifold gasket set. Make sure all parts are clean and any debris is removed.

87) Install the gasket on the studs of the manifold and mount the turbocharger with the turbo support bracket facing the inlet ports of the exhaust manifold. Install the four Nordlock locking washers and then start the locking nuts. Evenly tighten the four ½" nuts, going in a crossing pattern.

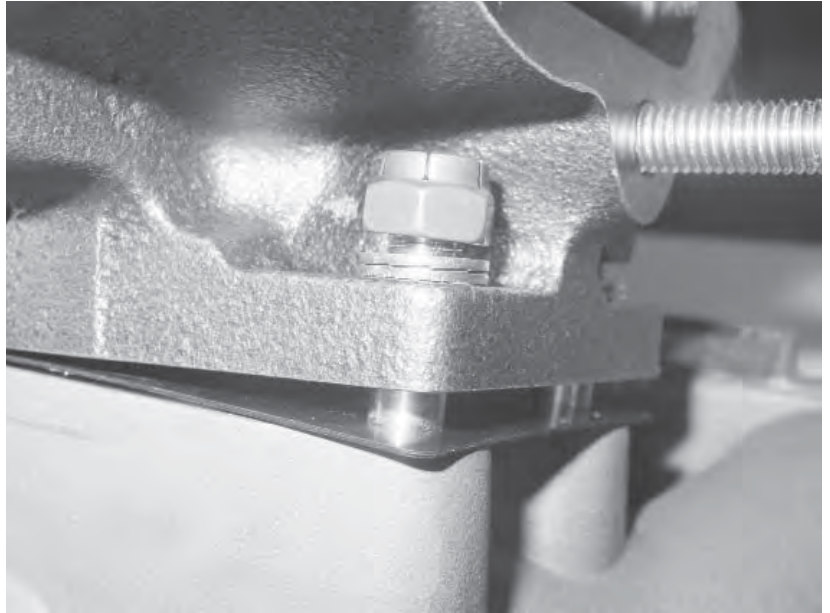

88) Install the five bolt turbo to downturn gasket and install the exhaust downturn. Install the five Nordlock washers and the copper locking nuts. Evenly tighten the 13mm, going from one side to another in a crossing pattern.

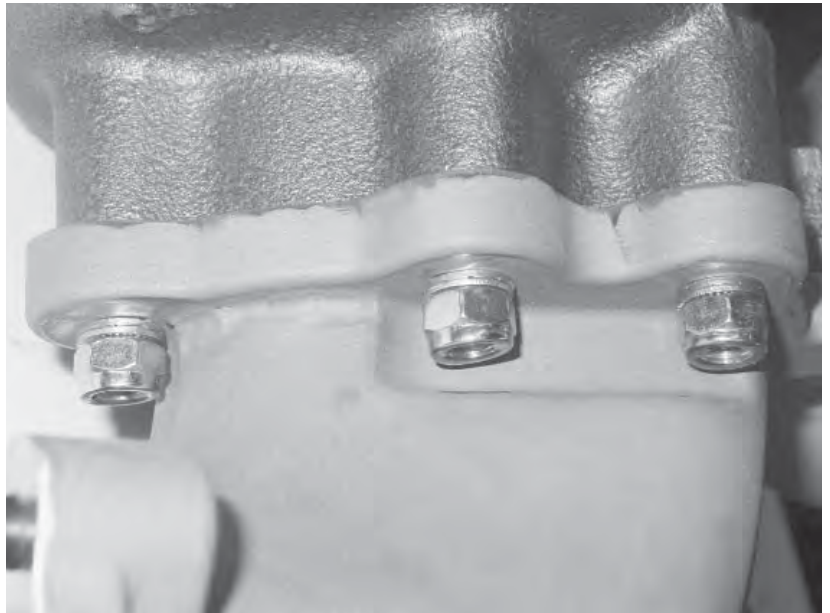

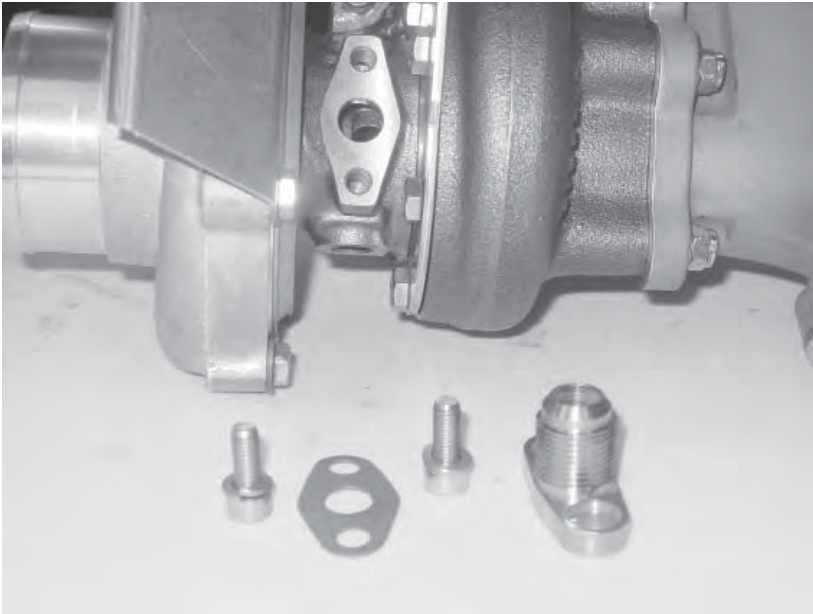

89) Install the gasket and oil drain flange to the bottom of the turbocharger using the supplied 6mm allen bolts.

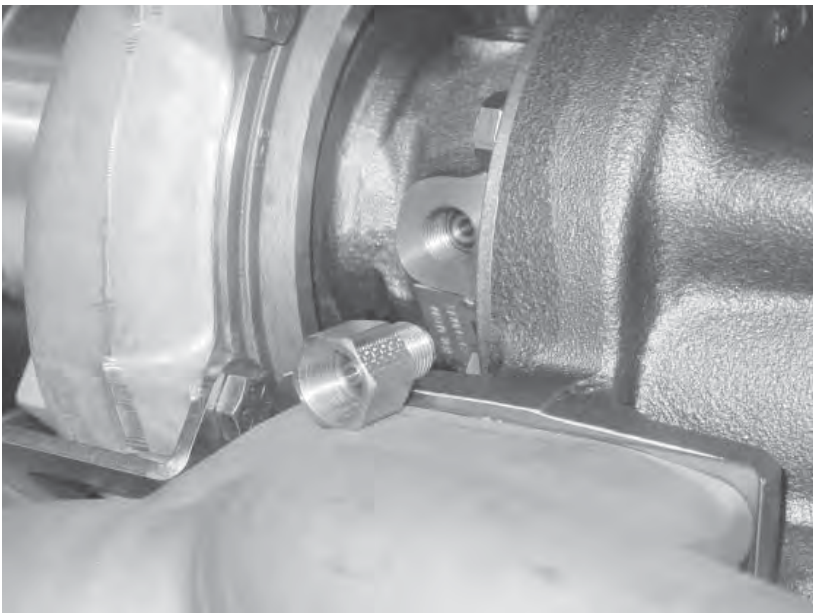

90) Install the oil feed line adaptor into the top of the turbocharger using a 5/8" socket.

91) Install the oil drain line onto the turbocharger using a 1" wrench.

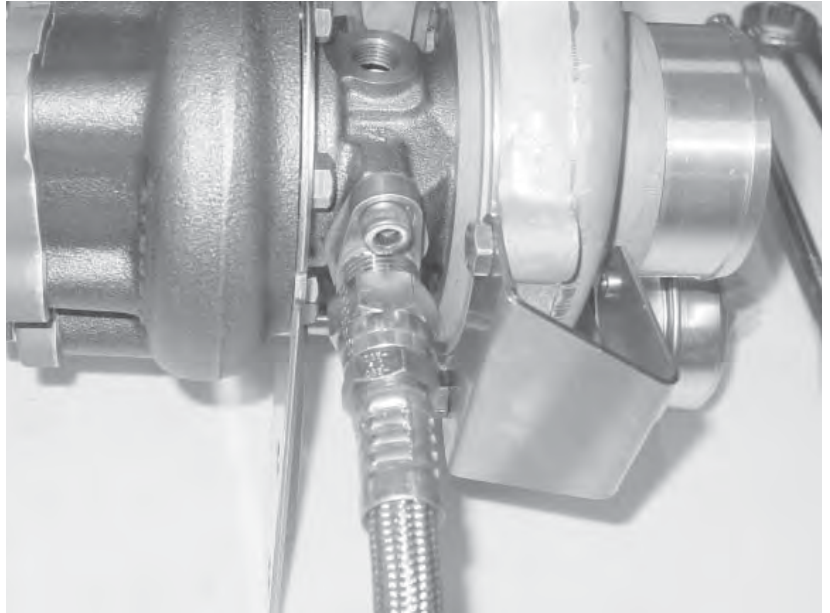

92) Install the rubber coolant line onto the inside of the turbocharger. Use a crush washer on both sides of the banjo fitting, and tighten the 19mm banjo bolt.

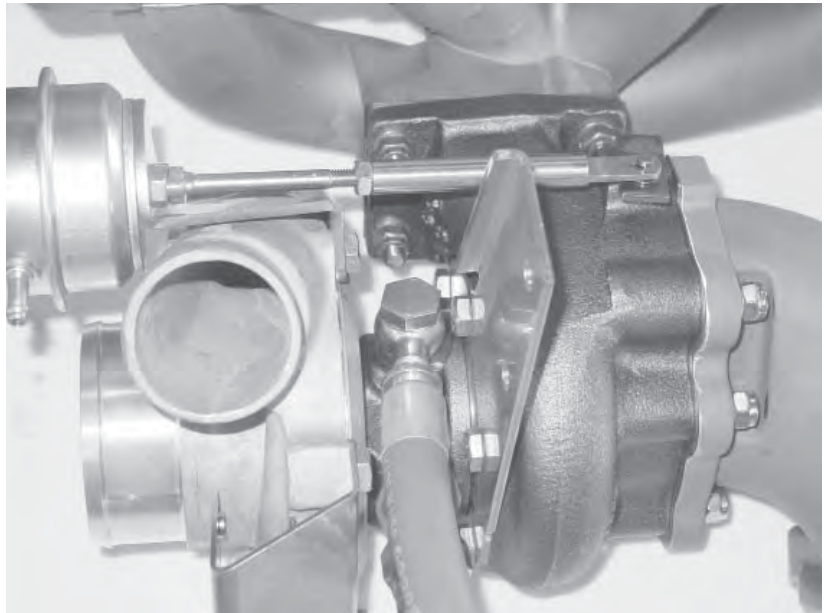



93) Install the other braided steel coolant line on the other side of the turbocharger. Again, install a crush washer on both sides of the banjo fitting, and tighten the 19mm banjo bolt.

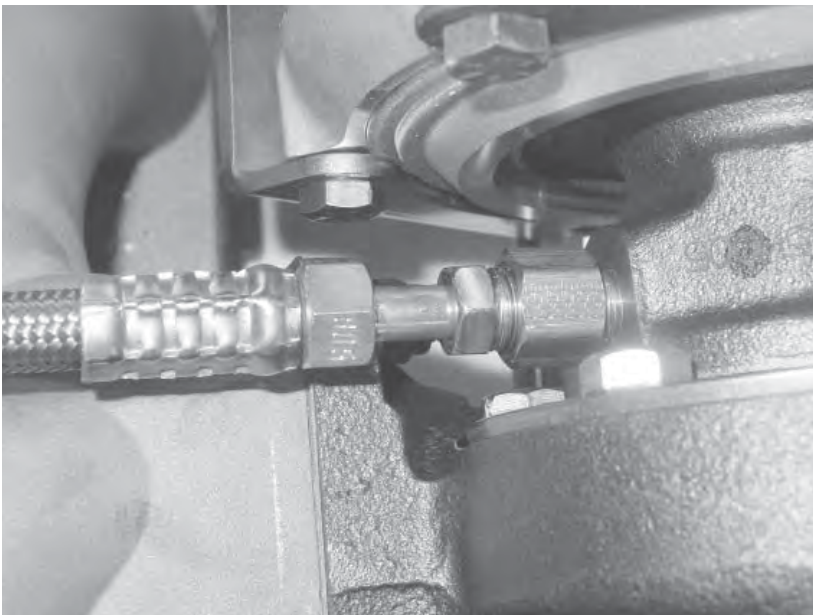

94) Install the oil feed line into the fitting previously installed on the turbocharger. Tighten the connection with a 1/2" wrench while holding the fitting with a 5/8" wrench.

95) Remove the two T25 screws from the N75 valve on the stock turbocharger. Using the same screws, mount the N75 valve to the APR turbocharger as shown.

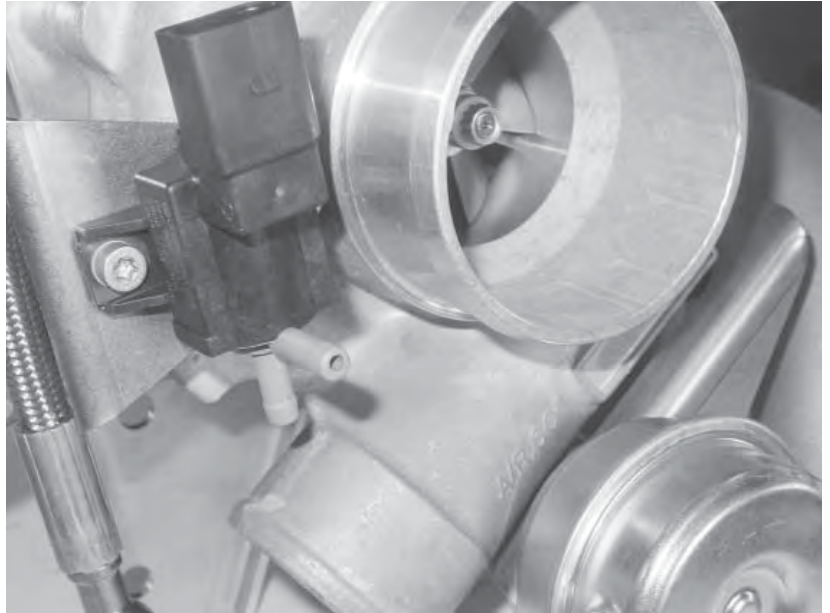

96) Cut ~5" of vacuum line and connect the N75 valve to the turbocharger wastegate. Crimp on with the supplied ear clamps.

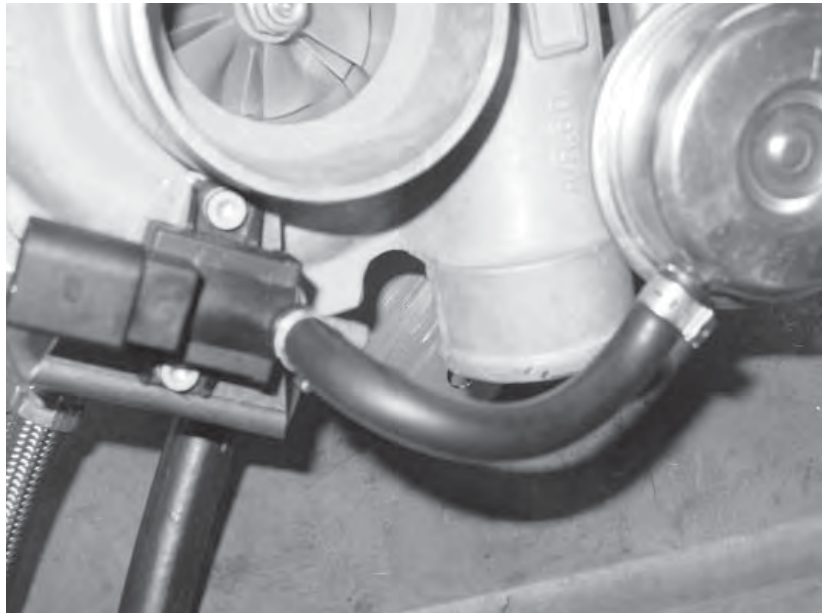

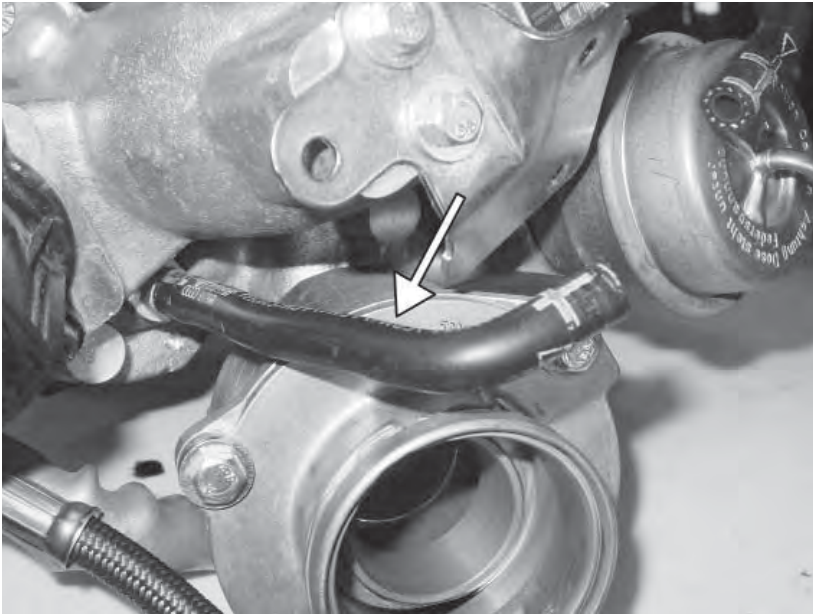

97) From the stock turbocharger, remove the lower vacuum line that was connected to the N75.

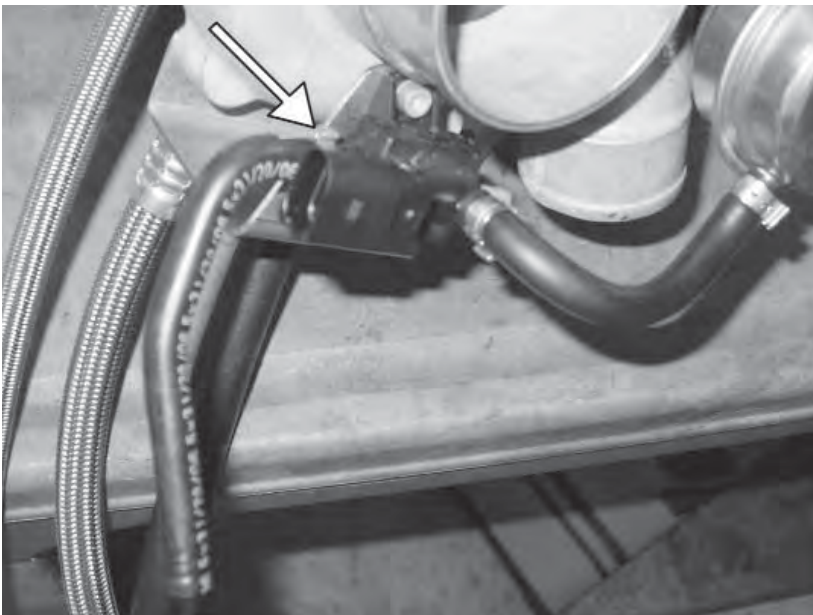

98) Connect the above hose to the N75 valve on the APR Turbo as pictured and crimp with the supplied ear clamps.

99) Cut 7.25" of vacuum line and connect to the last open port of the N75 valve. Crimp with the supplied ear clamps.

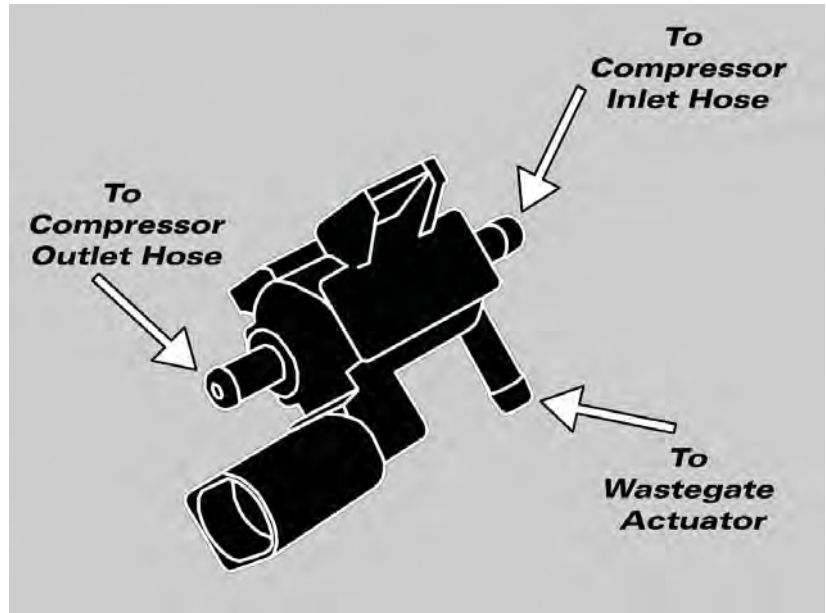

100) Pry the engine forward in the engine bay, and use the stock dogbone mount to hold the engine forward by wedging it against the transmission.

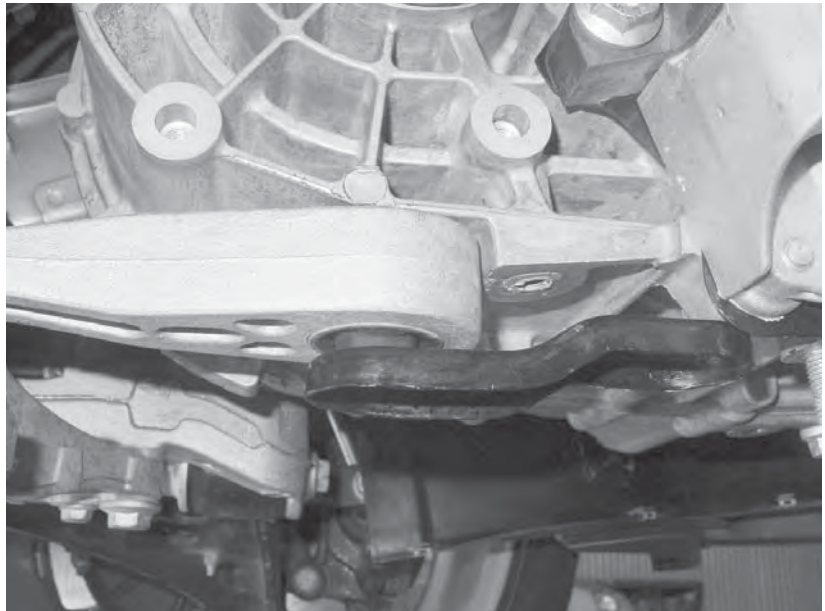

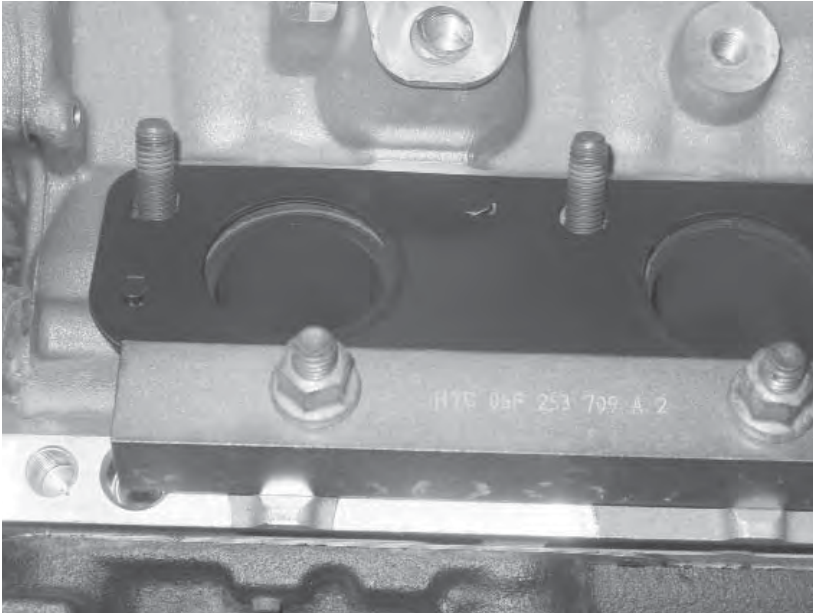

101) Remove old exhaust manifold gasket, if still installed, and replace with the new supplied gasket.

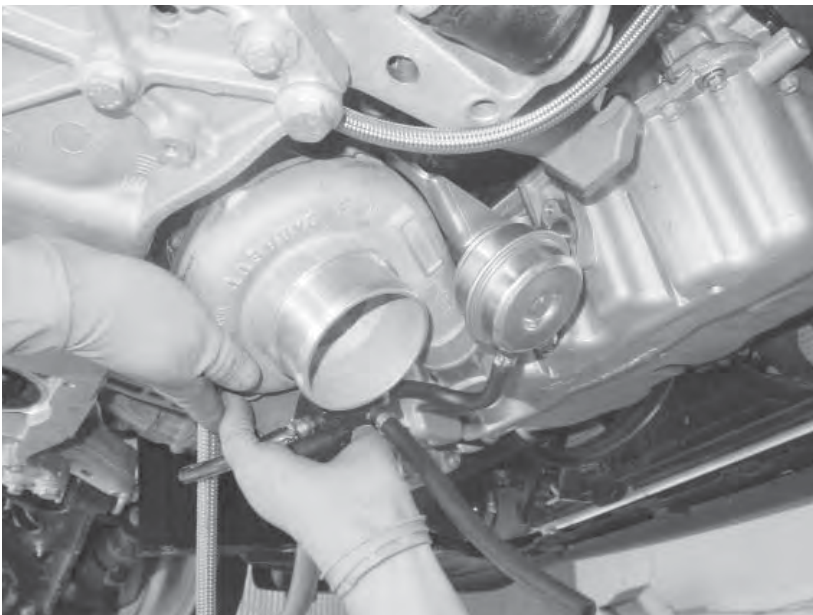

102) Lift the APR manifold/turbo assembly behind the engine as shown. Lift with the downturn end first as high as possible behind the engine, and then rotate the assembly into its correct orientation. Rest the manifold on the lower stock exhaust manifold brackets.

103) From above, thread the supplied flanged copper nuts onto the upper exhaust manifold studs. Tighten all exhaust manifold nuts to 15 lb-ft (upper and lower) from the center nuts to the outside ones in a crossing pattern.

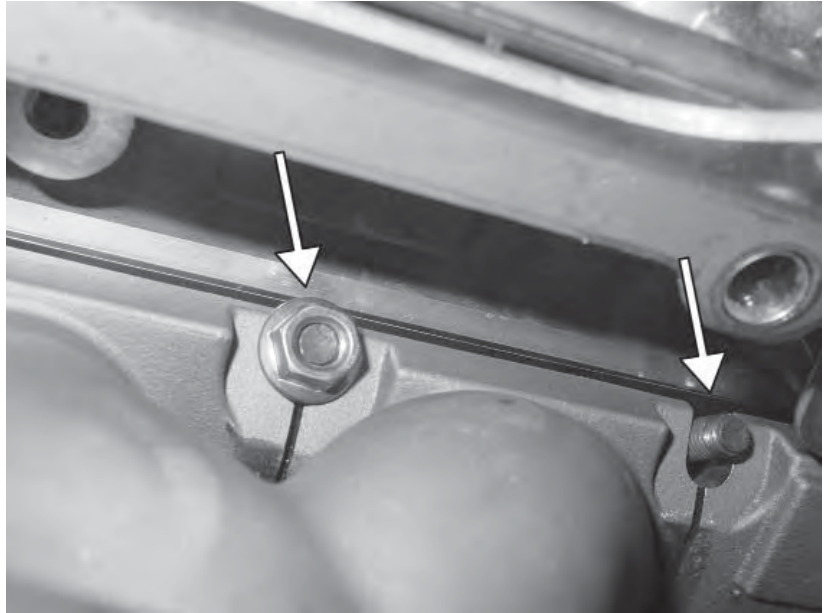

104) Reinstall the heat shield on the car and loosely attach with the two 8mm triple square bolts. Also loosely install the 10mm nuts that hold the coolant line to the heat shield. Finally, loosely install the supplied 12mm allen bolts where the stock 18mm bolts were. Tighten all fasteners.

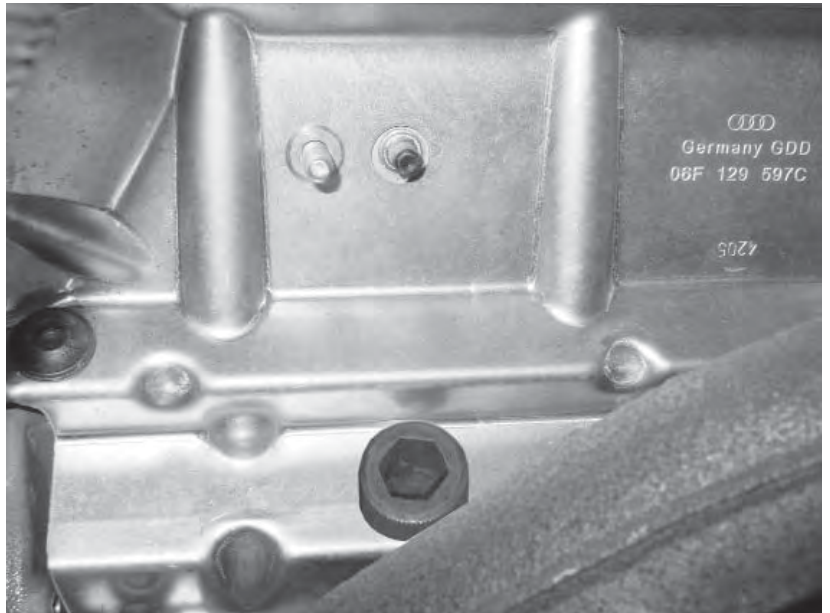

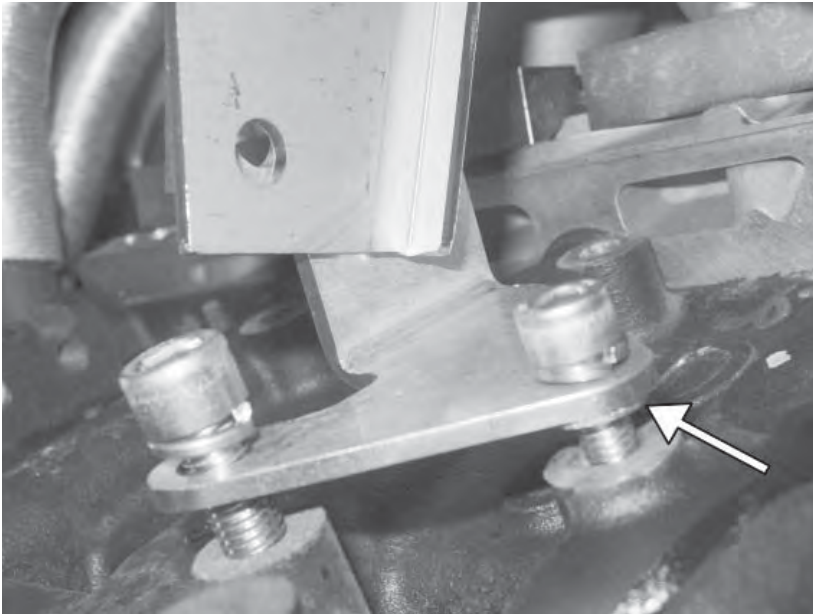

105) Loosely install the lower turbo support bracket to the engine block with the supplied 6mm and 8mm allen bolts. Note that there is an additional washer on the back side of the bracket on the 6mm bolt.

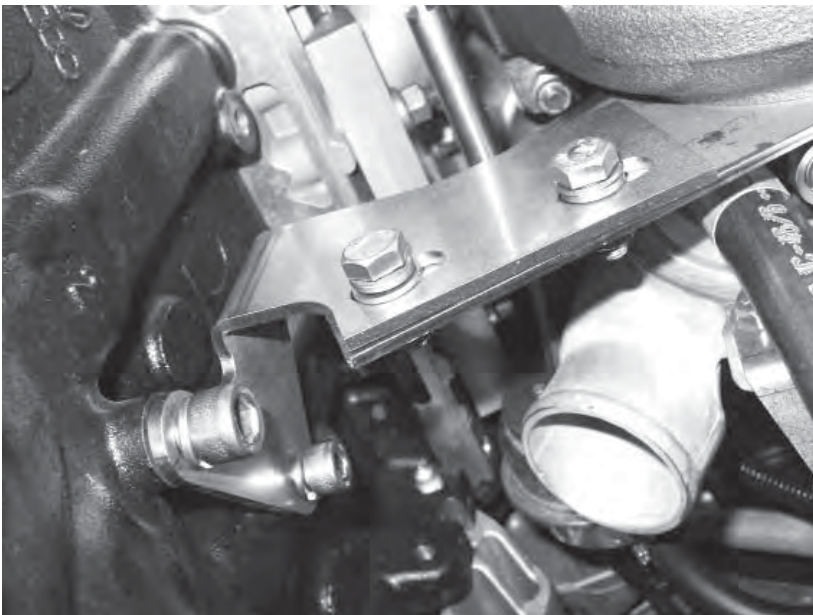

106) Loosely install the two 13mm bolts, lock washers, and 13mm nuts onto the turbo side of the support bracket. Tighten all fasteners to the turbo support bracket, starting with the allen bolts on the engine block. Do NOT loosen or remove the bolts connecting the bracket to the turbocharger.

107) From the stock airbox assembly, remove the two T20 screws from the stock MAF sensor. Install the sensor in the APR MAF tube using the supplied 3mm allen bolts. The sensor fits only one way into the MAF tube.

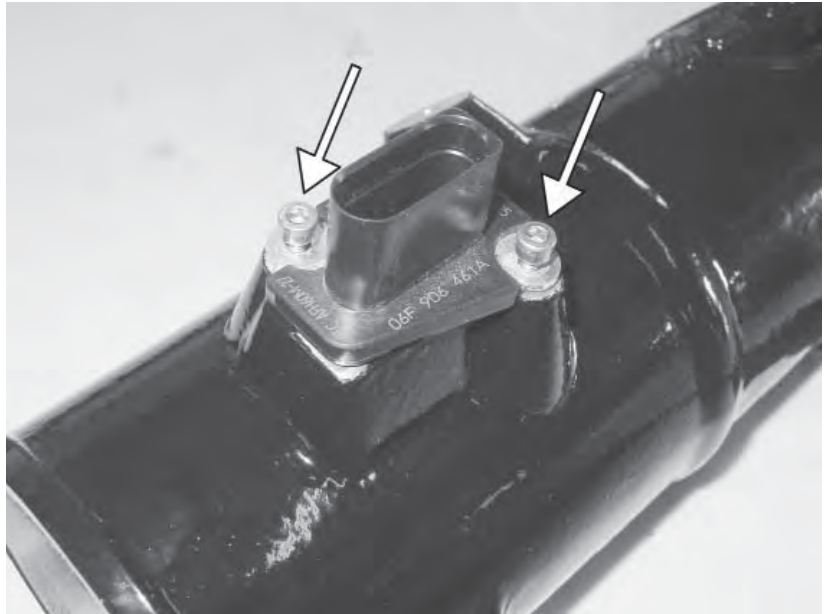

108) Loosely install the compressor inlet hose on the APR MAF Tube and lower into place on the car from above. From below, pull the compressor inlet hose down and place over the compressor inlet of the turbocharger.

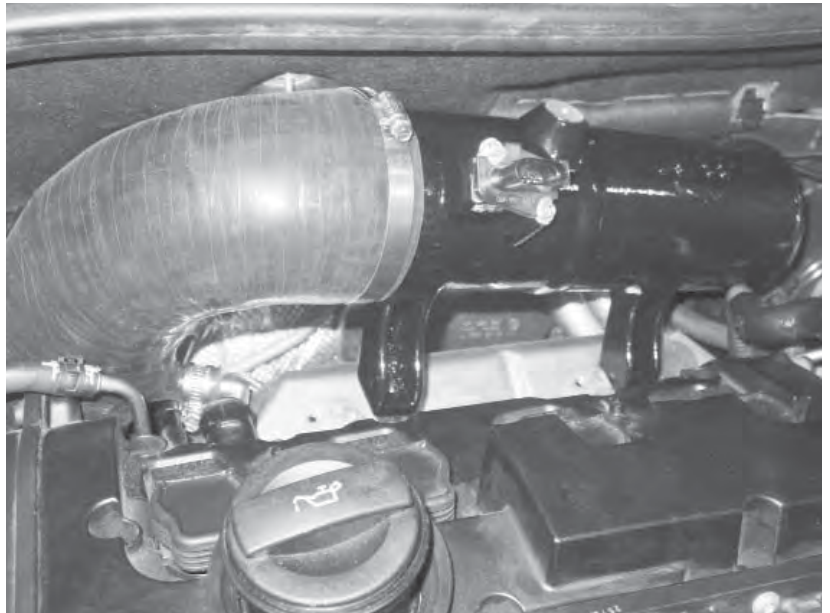

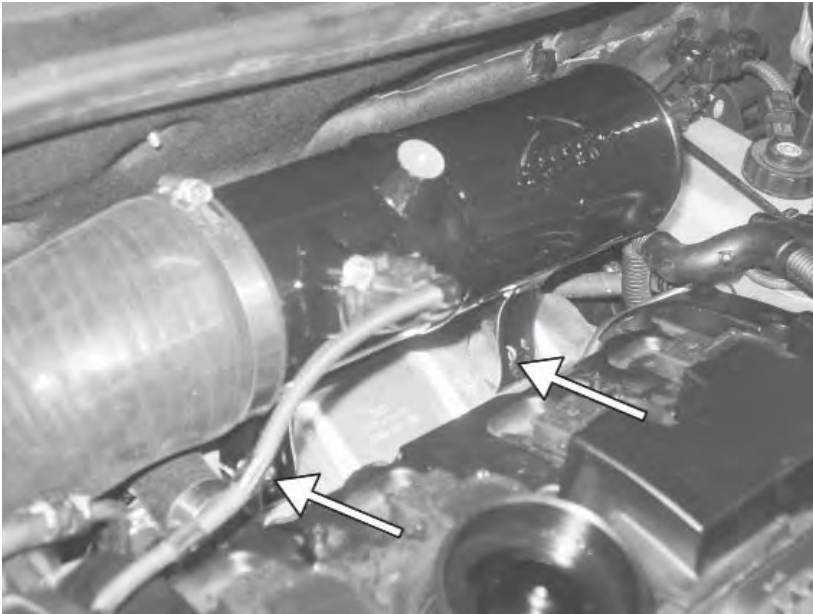

109) Install the two supplied 5mm allen bolts and lockwashers onto the MAF tube. Tighten the hose clamp from the compressor inlet hose to the turbocharger.

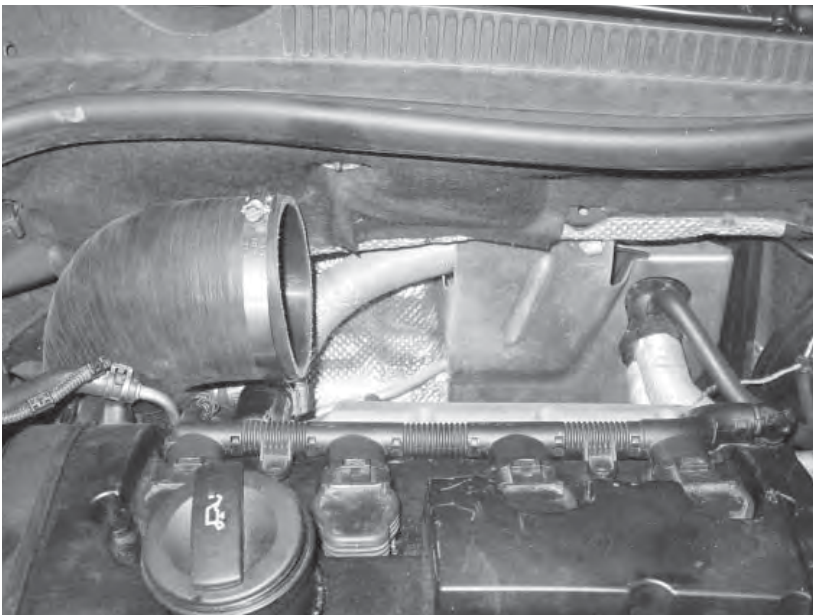

110) Remove the 5mm bolts and lockwashers and remove the APR MAF tube, leaving the compressor inlet hose in the car. It was necessary to install the MAF tube to get the correct orientation on the compressor inlet hose before tightening that hose in place.

111) Remove the 5mm allen bolts holding the diverter valve to the stock turbocharger. After confirming the diaphragm on the diverter valve is not torn, install the diverter valve on the supplied APR flange using the supplied 5mm allen bolts. Use a medium strength threadlocker on the bolts. Note that the diverter valve only installs one way the flange due to a detent.

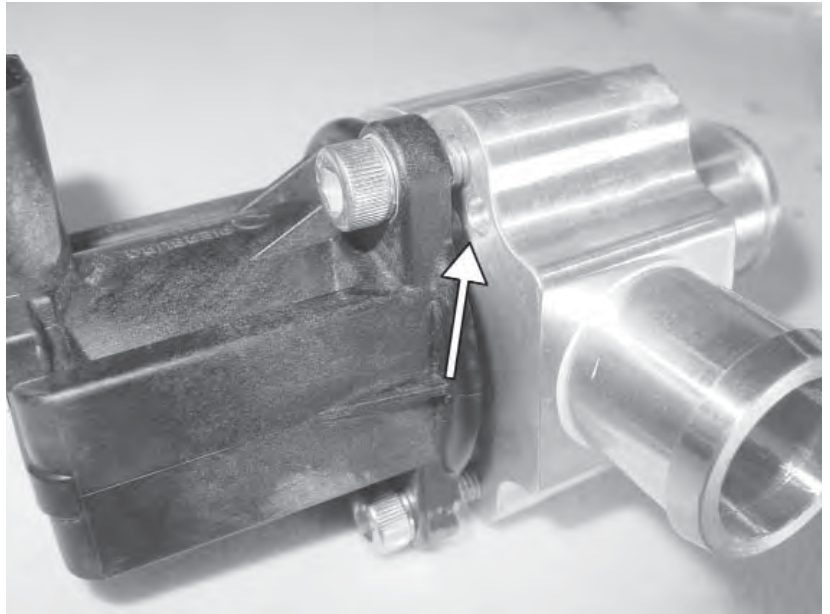

112) Loosely install the compressor outlet hose as shown. Also install the diverter valve flange. Make SURE the bottom of the flange goes in the compressor outlet hose. Tighten the hose clamps on the diverter valve flanges and the compressor outlet flange.

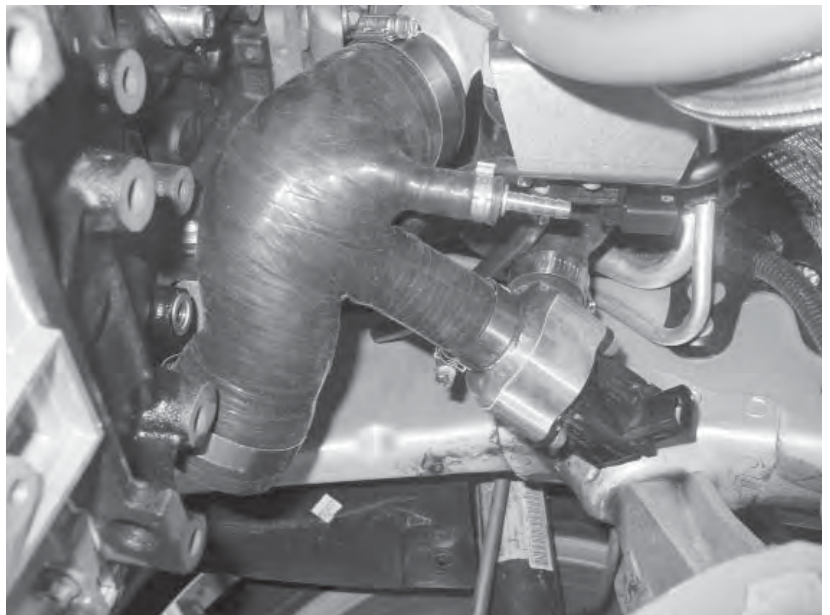

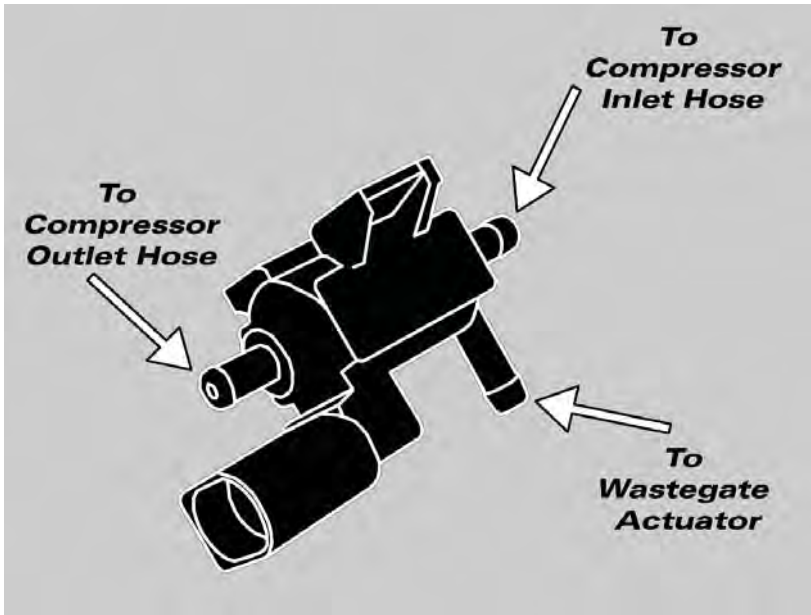

113) Connect the two other lines from the N75 valve as shown and crimp with the supplied ear clamps. The vacuum from the rearmost part of the N75 goes into the compressor outlet hose.

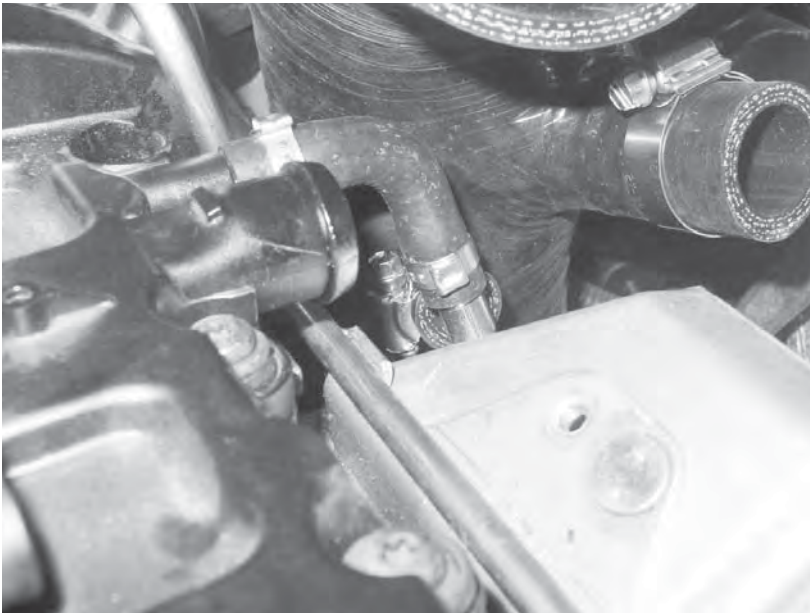

114) Install the plumbing for the small line on the upper side of the compressor inlet hose. The 90° barb fitting connects into the compressor inlet hose, and then to the small port on the back side of valve cover.

115) Install the APR supplied breather adapter flange onto the stock accordion tube using the supplied hardware. Connect the adapter side of the tube to the compressor inlet hose, and the other side to the larger port on the back side of the valve cover.



116) Install the supplied stepped bar fitting into the upper coolant line that was previously cut with a crimped hose clamp. Route the lower rubber coolant line off the turbocharger as shown, and connect to the upper coolant line from underneath. Install the other crimp clamp on the coolant line.

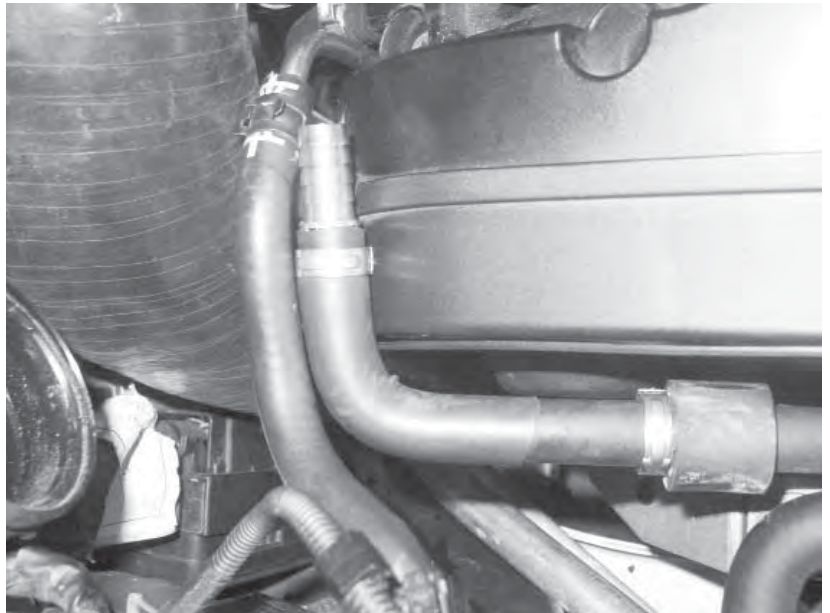

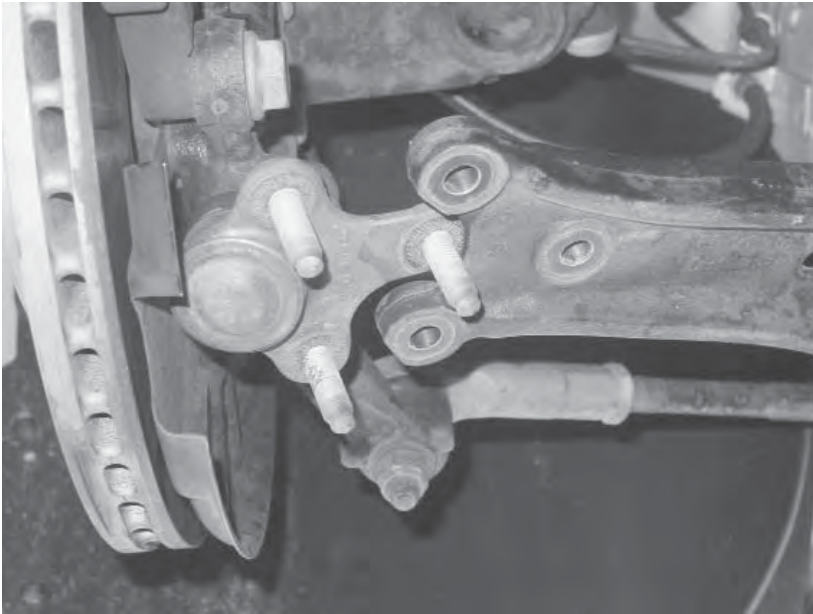

117) Reinstall the passenger axle into the car, making sure the splines on the axle line up into the hub. Reinstall the three 16mm nuts on the ball joint on the lower control arm.

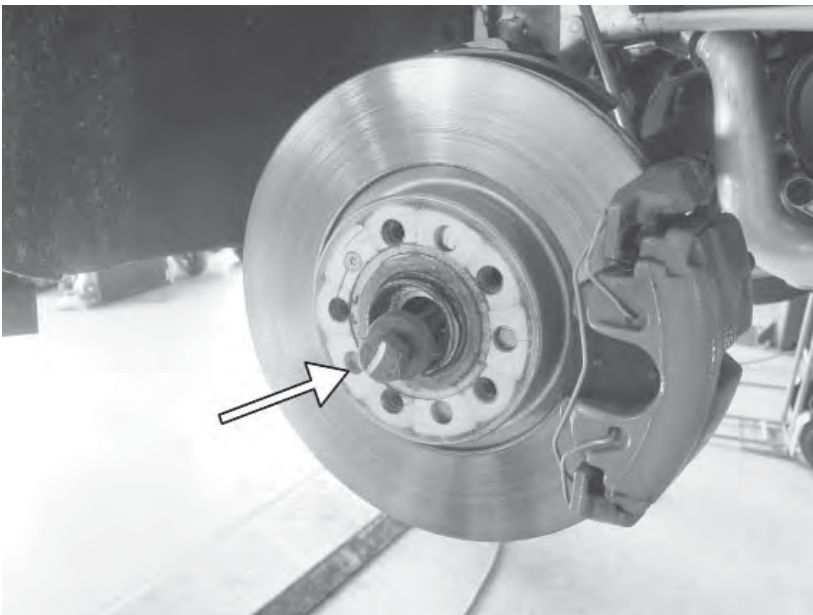

118) Reinstall the axle bolt. Have a partner hold the brakes on the car, and then further tighten the bolt to 148lb-ft. Then tighten the bolt an additional 180°. Install the six 10mm triple square bolts and bolt straps to the inner joint of the axle and tighten.

119) Install the oil feed line with the supplied 17mm banjo bolt. The oil feed line is the line that runs to the top of the turbocharger. Route the line as shown, underneath the axle, and make sure there are crush washers on both sides of the bolt, and tighten the banjo bolt.

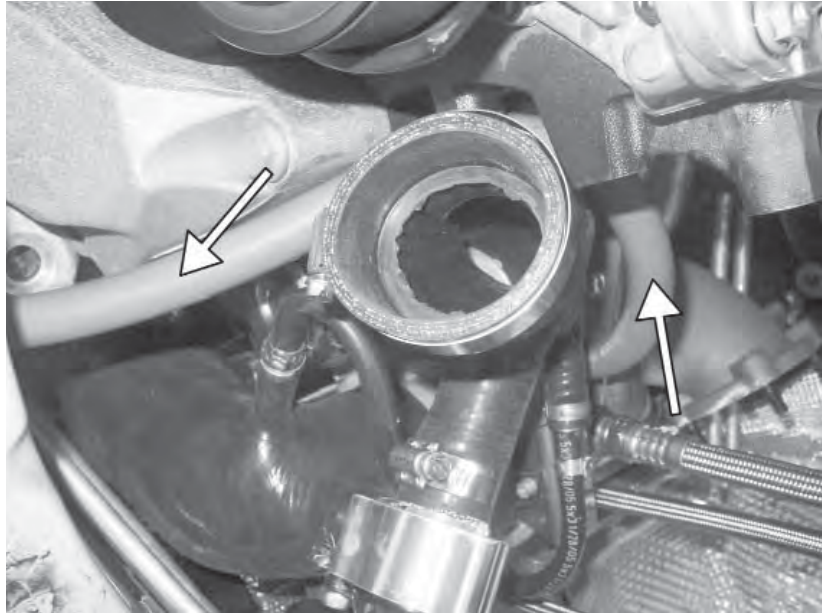

120) Install the other coolant line with the supplied 19mm banjo fitting onto the block as shown. Make sure there is a crush washer on both sides of the bolt and tighten the banjo bolt.

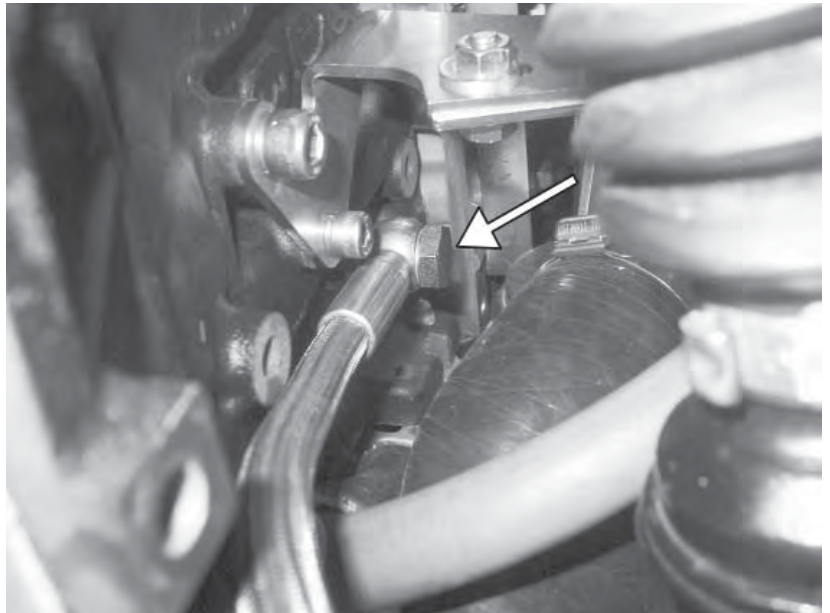



121) Install the oil drain line fitting onto the oil pan with the supplied gasket, 5mm allen bolts, and lockwashers. Install the oil drain line and tighten with a 1" wrench.

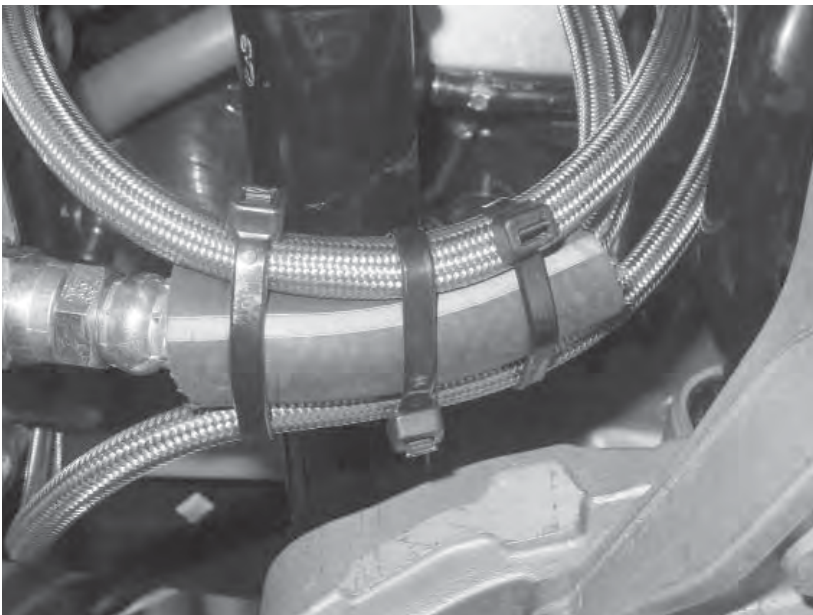

122) Install the rubber grommet on the oil feed line. Connect all three lines (oil feed, oil drain, and coolant) together as shown and secure with the three cable ties to prevent chaffing on the lines.

123) Remove the two rubber grommets and metal bushings from the stock metal compressor outlet pipe and install on the APR outlet pipe.



124) Loosely install the APR outlet pipe into the compressor outlet hose and to the passenger side intercooler hose. Secure the APR outlet pipe to the oil pan using the two stock T30 bolts. After confirming the hoses are not kinked, tighten the hose clamps on both ends of the APR outlet pipe.

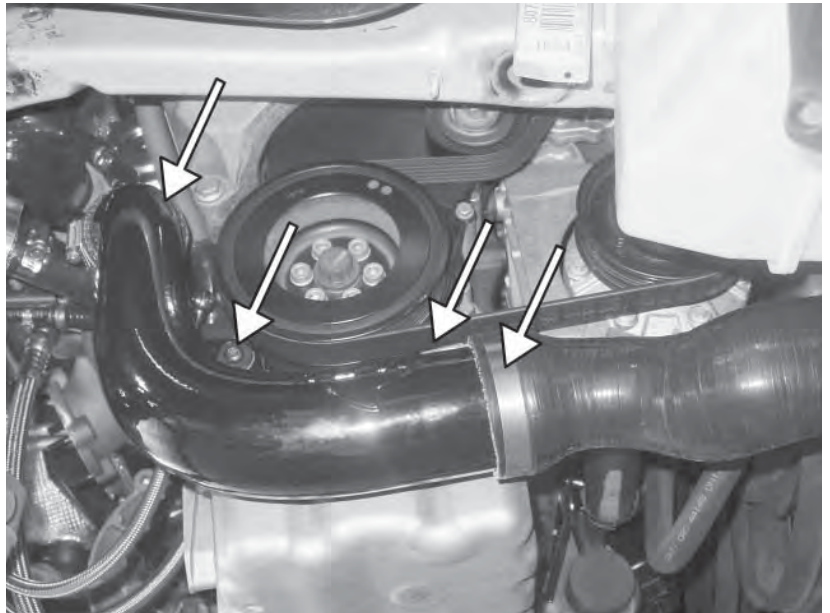

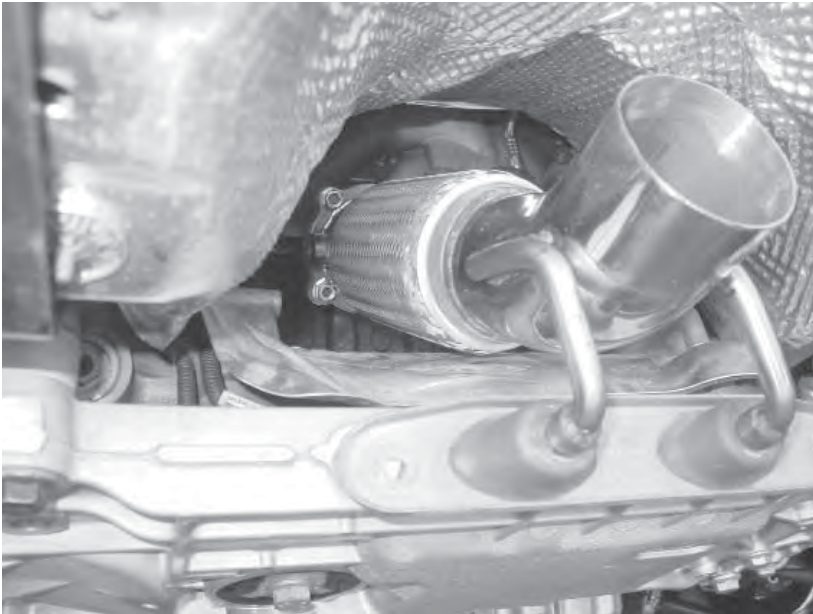

125) Install the supplied downpipe and gasket onto the APR downturn with the four 14mm nuts. Connect the rest of the exhaust system to the downpipe.

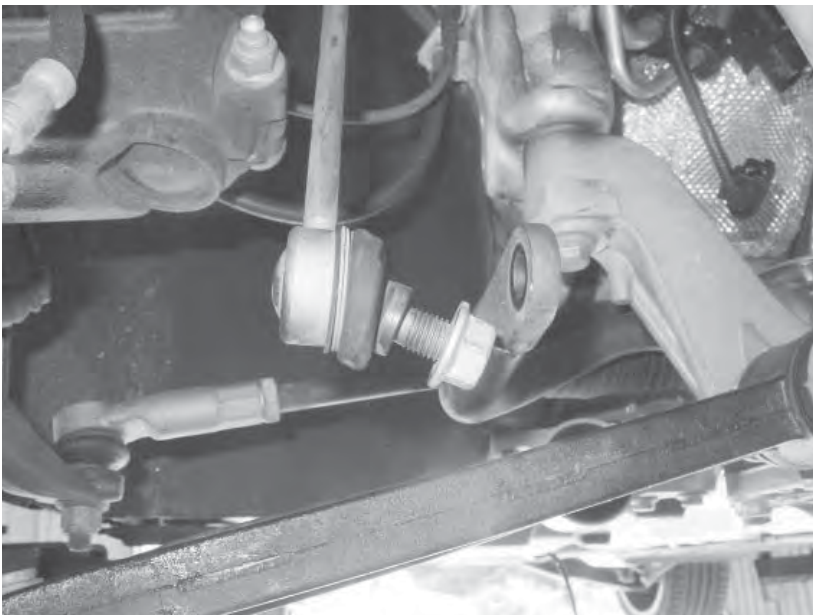

126) Reinstall the sway bar end link with the 18mm nut. Also reconnect the engine dogbone mount with the two 16mm bolts.

127) Remove the stock coilpacks and sparkplugs. Check the gap on the APR plugs and verify/regap to .028". Install the new spark plugs and torque to 18lb-ft. Reinstall the coilpacks.

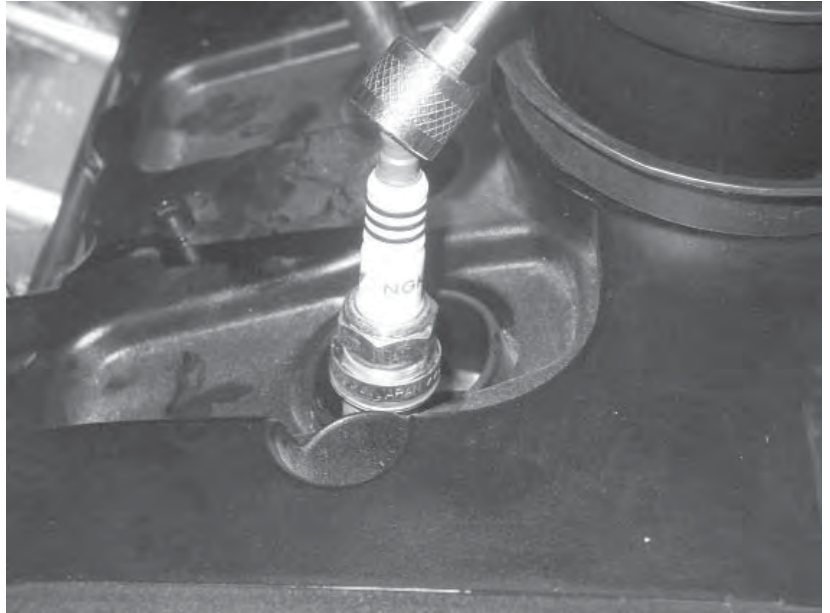

128) Reinstall APR MAF tube into the compressor inlet hose. Secure with the 5mm allen bolts and some red loctite thread fastener. Reconnect the MAF sensor wiring harness.

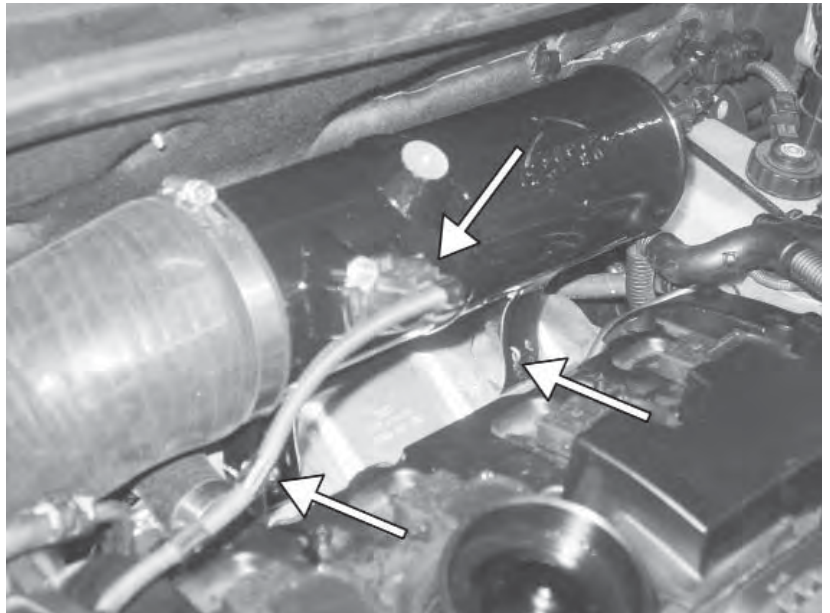

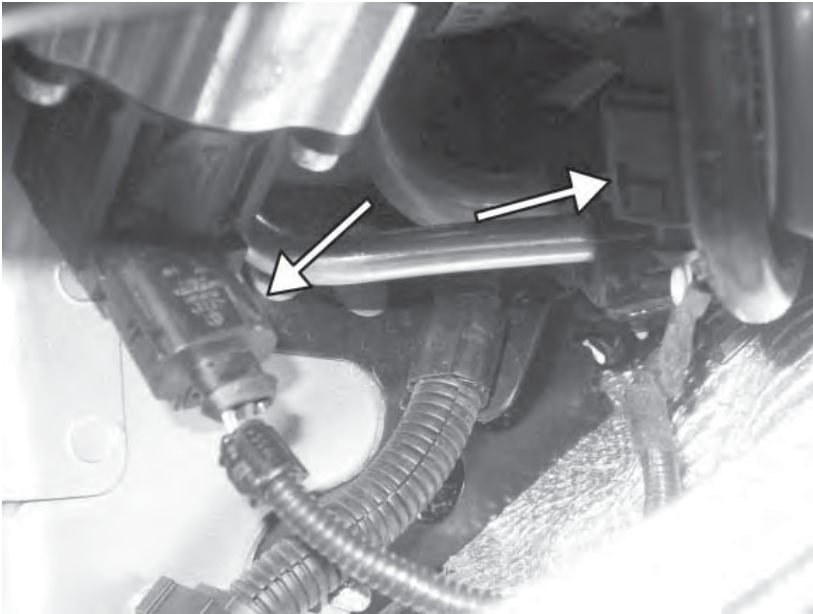

129) Reinstall the coilpack wiring harness and drop the wires down the back of the passenger side that connect to the N75 valve and diverter valve. Be sure to route these lines behind the A/C lines. From underneath, reconnect the N75 valve and diverter valve wiring harness.

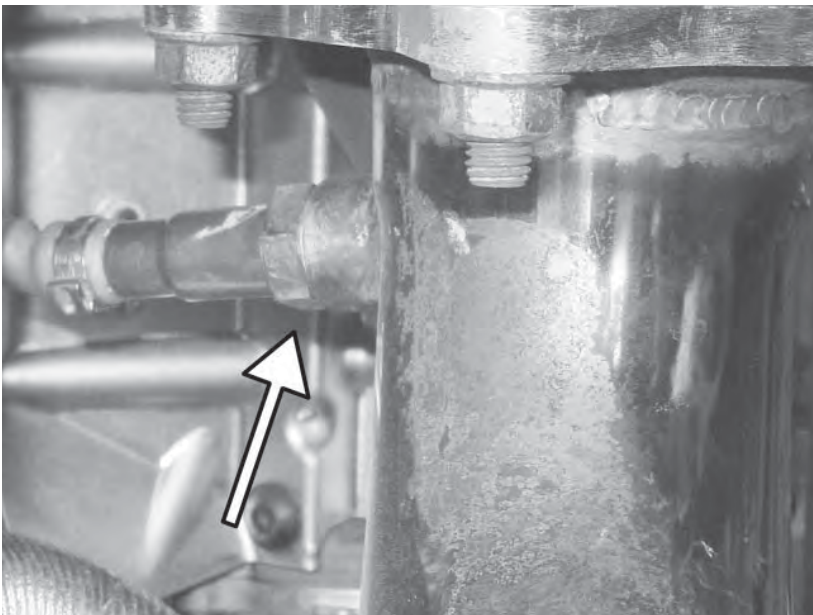

130) Reinstall the O2 sensors into the downpipe and tighten them with an oxygen sensor socket. Route the wiring for the sensors up and reconnect to the factory clips and electrical connectors.

131) Install the rest of the intake system as show, but leave the hose clamps loose. Preinstall the metal inlet elbow into the pipe by the fenderwell.

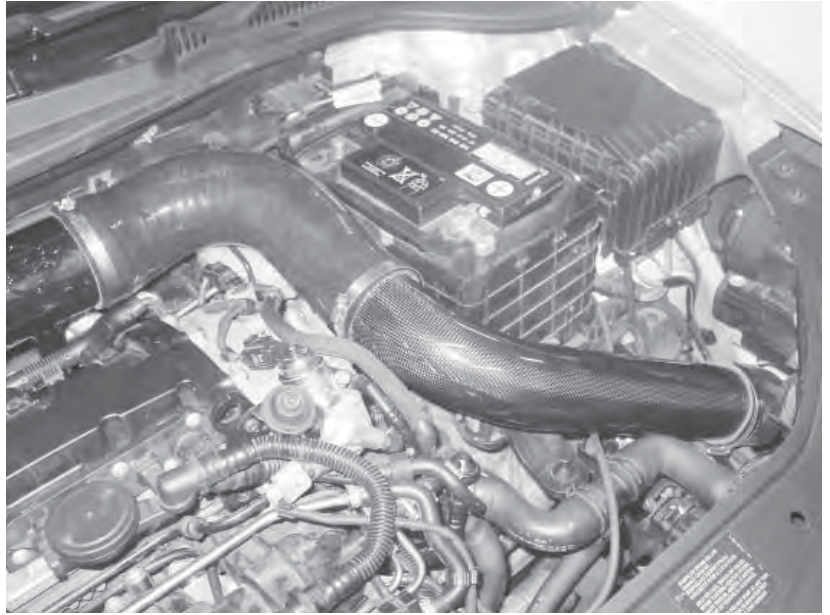

132) Remove the bolt nearest the inlet elbow and then install the air filter and clamp with attached bracket. Loosely install the bolt with the bracket, tighten the clamp on the filter, and then tighten the bolt.

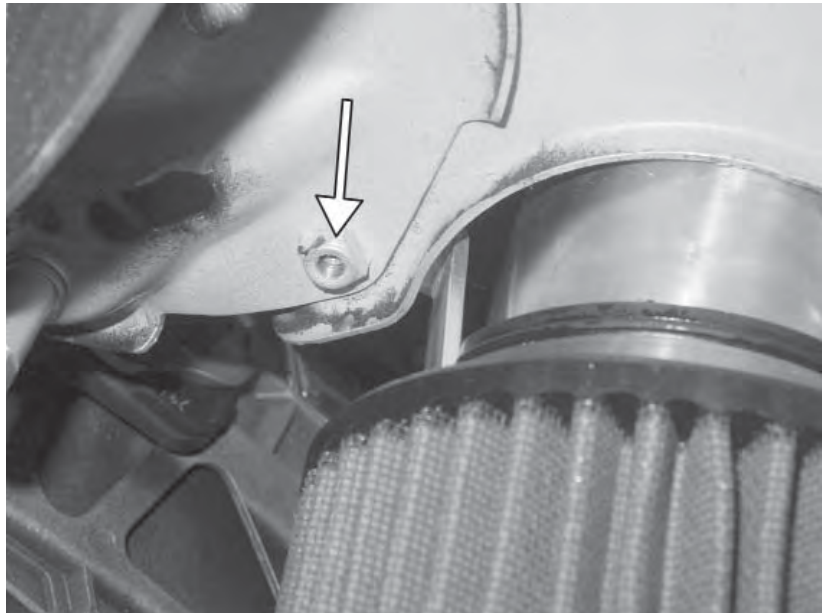

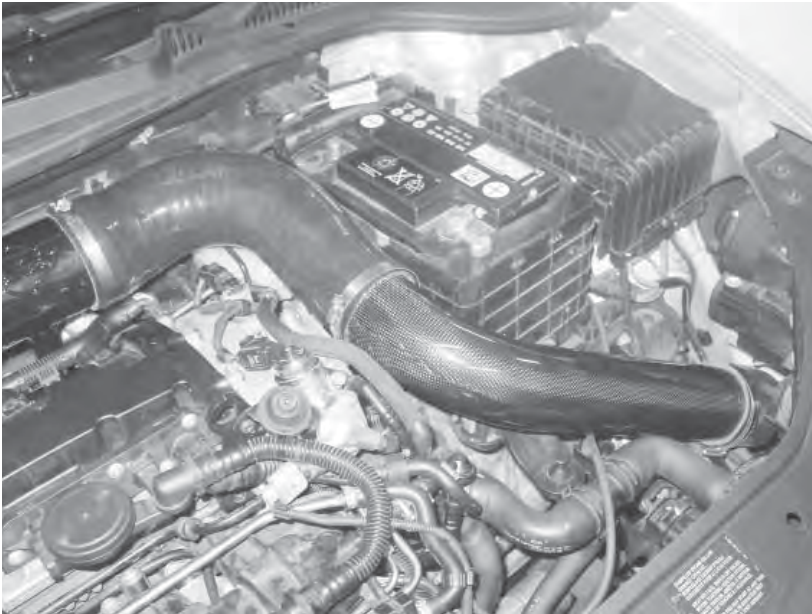

133) Rock the intake back and forth and make sure that it does not hit anything. Make any adjustments necessary, and then tighten all of the clamps on the intake.

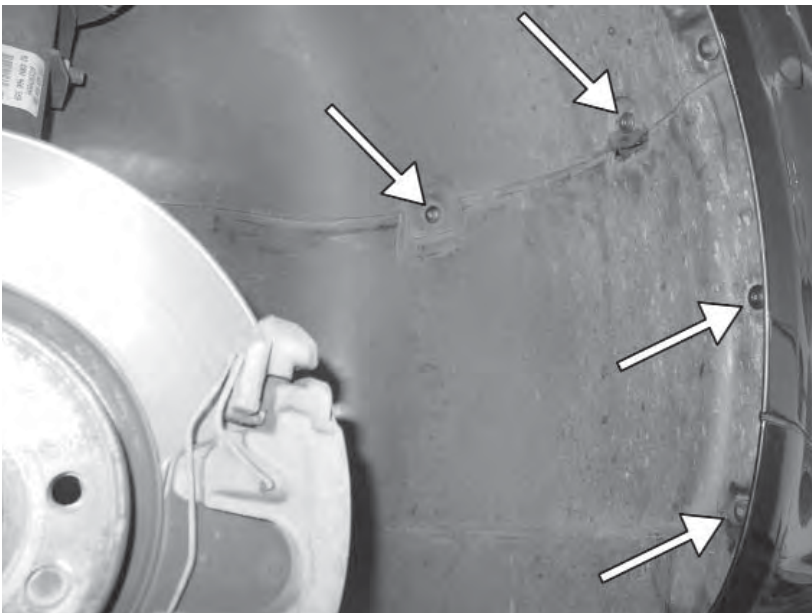

134) Reinstall both the driver and passenger side wheel well liners with the stock T25 screws. Leave the belly pan off for the initial testdrive, so you can check for leaks or reinstall the intercooler hose that blew off that you didn't tighten enough.

135) Reinstall the front passenger wheel and torque the lug bolts to 89lb-ft.



136) Fill the engine with oil and coolant. Use ONLY G12 plus coolant, and leave the reservoir cap off.



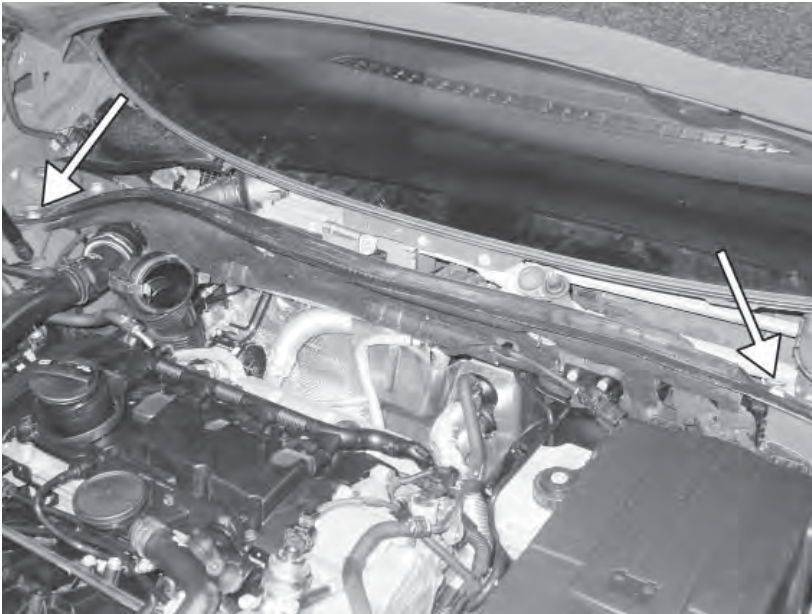

137) Reinstall engine ECU, noise resonance chamber, cowl panel, plastic cowl cover and windshield wipers.



138) Reconnect negative battery terminal. Let the car sit for at least three minutes with the ignition key on and engine off. This is a good time to connect with a diagnostic tool and clear any error codes on the car.

139) Start the engine and let idle for ten seconds. Turn the engine off and check the engine oil level, topping off if necessary.

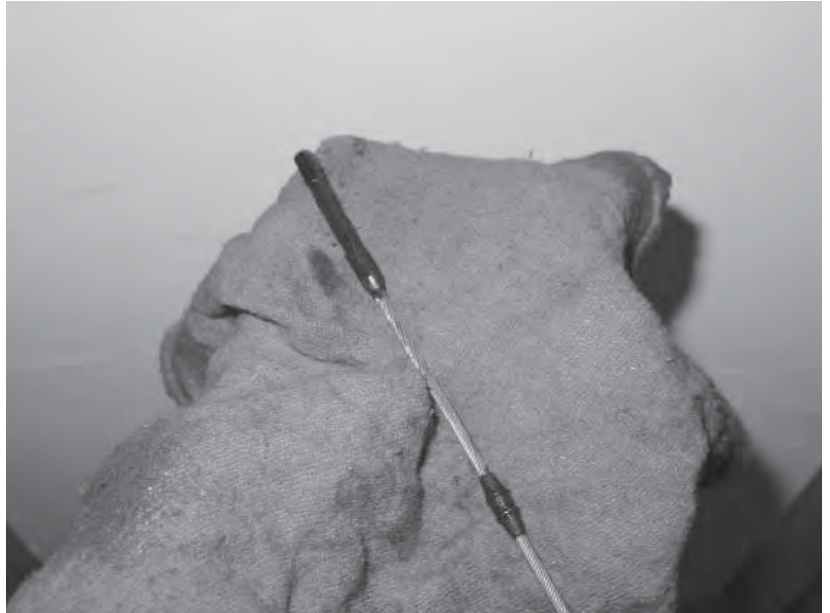

140) Restart the engine and check for any oil or coolant leaks as the engine idles. Let the engine come up to temperature in order to bleed the coolant. Smoke from the engine bay is normal as the oil and grease from your hands burns off the new components.

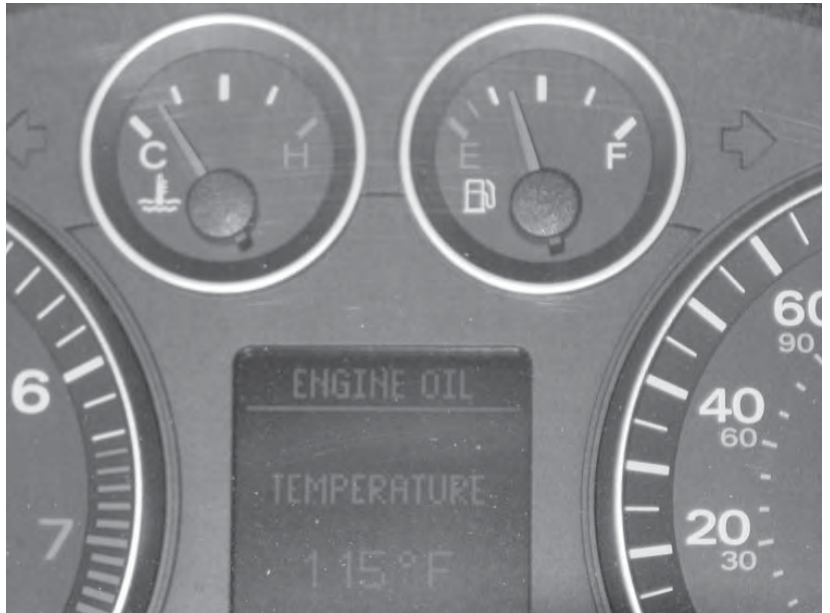



141) Check the engine coolant level and fill if necessary. Reinstall the reservoir cap before the thermostat on the car opens.



142) Turn off the engine and check for any leaks from underneath the car.

NOW WAIT BEFORE DRIVING AND READ THIS!!

CONGRATULATIONS!

You just successfully installed your Stage III kit on your already great 2.0T. This kit completely transforms the car in more ways than you can imagine. Don't take your car out and drive it hard without first getting used to the new power. It would suck to have just spent all the time, money, and frustration you did on your car to go out and wreck it!! Here is what we advise for your first drive...

Get a friend who knows something about cars to go for the first drive with you. Grab your wallet (with some cash in it), your cell phone, and some basic tools in case you have a problem with that hose clamp or bolt that you forgot to tighten. Get all the extra boxes and junk you have in the back of your car out so they don't go flying around. Get in your car and PUT ON YOUR SEAT BELT!

Make sure your engine is fully up to temperature before going for a drive. Try not to pull out in traffic so you can have some time to react if something happens to your car. Use light throttle inputs and be easy on the car. As you start to drive you will hear some of the new noises it makes. It will take you some time to distinguish between what sounds normal and what is a problem. Don't worry too much for now about all of the air rushing noises that you hear, but make sure that you don't hear anything rattling or hitting things that they should not be hitting.

Gradually build up to driving your car with its newfound power. Soon, you will hear a new hissing sound, which is the sound of your tires spinning in second and third gear. Be careful about how much power you use in lower gears. Do not add too much power when in a turn, only when the car is pointed straight. You will get more comfortable with this power as time goes by...

Before you realize it, your brakes will not be working like they used to. They faded away when you made that stop after the third gear run. Go home now and don't try to get a ticket from racing that STi you saw heading the other way. Welcome to the next level. Welcome to Stage III.

