



# AIRCHARGER™

## HIGH-FLOW INTAKE KITS

LEGAL IN CALIFORNIA ONLY FOR RACING VEHICLES WHICH MAY NEVER BE USED, REGISTERED OR LICENSED FOR USE UPON A HIGHWAY.

See knfilters.com for CARB status on each part for a specific vehicle

### INSTALLATION INSTRUCTIONS

**63-2578**  
**FORD**  
**2011-14 Mustang GT**  
**V8-5.0L**

**TOOLS NEEDED:**

- Extension
- Flat Blade Screwdriver
- Ratchet
- Side Cutter Pliers
- T20 Torx Socket
- 10mm Socket
- 3mm Allen Wrench
- 5mm Allen Wrench

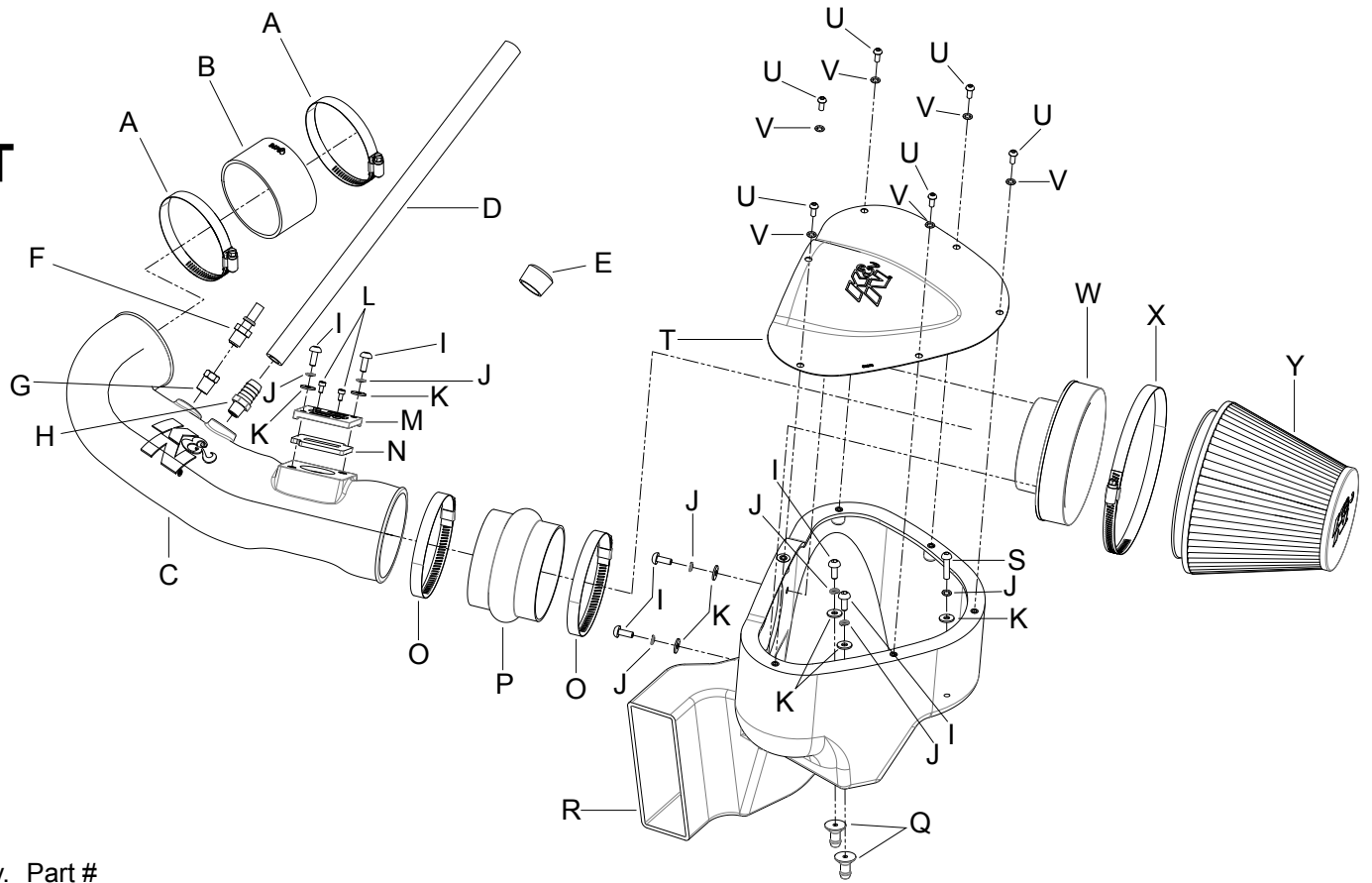

**PARTS LIST:**

| Description                             | Qty. | Part # | Description                         | Qty. | Part # | Description                          | Qty. | Part #  |
|---|------|--------|-------------------------------------|------|--------|--------------------------------------|------|---------|
| A Hose Clamp #56                        | 2    | 08620  | J Washer, M6 Split Lock Zinc        | 7    | 1-3025 | S Bolt; M6-1.00 X 25mm BtnHd, SS     | 1    | 07729   |
| B Hose; 3-1/2" ID X 2" L Reinforced     | 1    | 08698  | K Washer, 6mm Flat, SS              | 7    | 08269  | T Lid; Carbon Fiber                  | 1    | 05870   |
| C Intake Tube (ID)                      | 1    | 087244 | L Bolt; M4- 0.07 8mm, A/H Cap, SS   | 2    | 07733  | U Bolt; M5-0.8 X 12mm B/H, SS        | 6    | 07734   |
| D Hose; 1/2"ID X 17"L                   | 1    | 08177  | M Adaptor; Nylon 6/6 GF, Blk.       | 1    | 21515  | V Washer; 5mm Internal Star Cut Lock | 6    | 07724   |
| E Caplug; 15/16" ID, 3/4" L, Blk. EPDM  | 1    | 08246  | N Gasket; 3/16 Poron                | 1    | 09069  | W Adaptor, #454                      | 1    | 27300   |
| F Vent; STRT, 1/4" NPT to Quick Release | 1    | 08938  | O Hose Clamp #64 Stainless          | 2    | 08645  | X Hose Clamp # 104                   | 1    | 08697   |
| G Plug; 1/4 NPT, Plastic, Blk.          | 1    | 08032  | P Hose; 4" ID X 3"L Hump Reinforced | 1    | 08418  | Y Air Filter                         | 1    | RF-1048 |
| H Vent; STRT; 5/8 Barbed 1/4 NPT, Nylon | 1    | 08911  | Q Nipple, Heat Shield Mount Blk.    | 2    | 8-186  |                                      |      |         |
| I Bolt; M6 X 1.00 X 16mm, BtnHd, SS     | 6    | 07730  | R AirBox                            | 1    | 087245 |                                      |      |         |

**NOTE: FAILURE TO FOLLOW INSTALLATION INSTRUCTIONS AND NOT USING THE PROVIDED HARDWARE MAY DAMAGE THE INTAKE TUBE, THROTTLE BODY AND ENGINE.**

**TO START:**

1. Turn off the ignition and disconnect the negative battery cable.

**NOTE: Disconnecting the negative battery cable erases pre-programmed electronic memories. Write down all memory settings before disconnecting the negative battery cable. Some radios will require an anti-theft code to be entered after the battery is reconnected. The anti-theft code is typically supplied with your owner's manual. In the event your vehicles' anti-theft code cannot be recovered, contact an authorized dealership to obtain your vehicles anti-theft code.**



2. Lift up the engine cover and remove it from the vehicle.



3. Cut the clamp that secures the engine pulse hose to the drum and disconnect the hose from the drum.



4. Release the clamp which secures engine pulse hose to the intake tube then remove the engine pulse hose from the vehicle.



5. Install the provided cap onto the drum as shown.



6. Unhook the mass air sensor electrical connection.



7. Disconnect the crankcase vent hose from the factory intake tube and valve cover port and remove the vent tube from the vehicle.

**NOTE: Some models may be equipped with the EVAP vent hose, it will be necessary to disconnect the EVAP vent hose from the factory intake tube.**



8. Loosen the hose clamp that secures the factory intake tube to the throttle body.



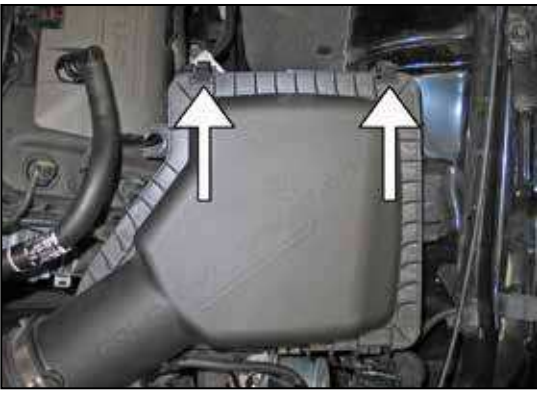

9. Release the two upper airbox retaining clips.



10. Remove the upper airbox and intake tube from the vehicle.



11. Remove the bolt that secures the lower airbox to the inner fender.

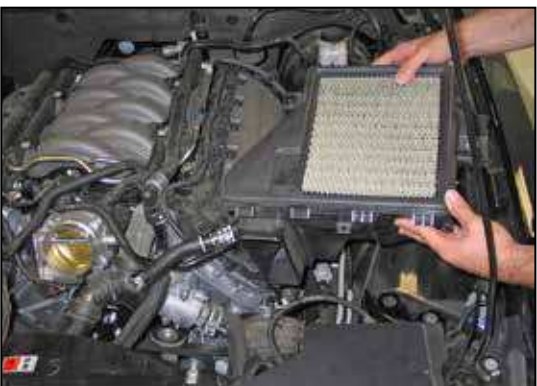

12. Remove the lower airbox from the vehicle.  
**NOTE: K&N Engineering, Inc., recommends that customers do not discard factory air intake.**

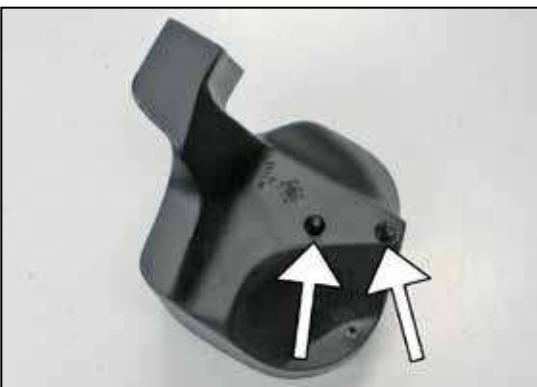

13. Install the two airbox mounting studs onto the bottom of the airbox and secure with the provided hardware.

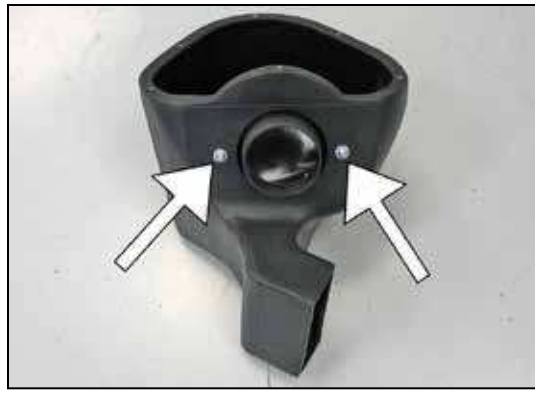

14. Install the filter adapter into the airbox and secure with the provided hardware.

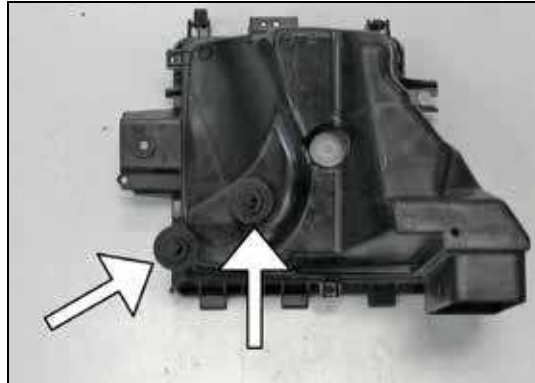

15. Remove the two airbox mounting grommets from the factory airbox.

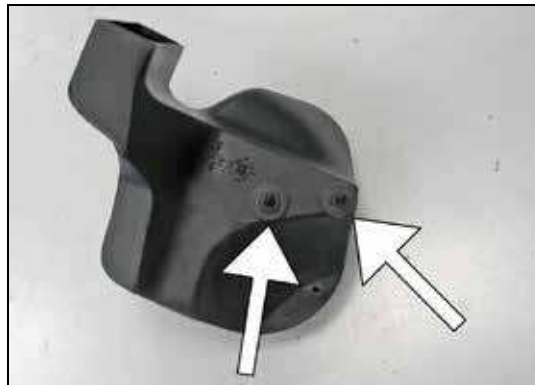

16. Install the airbox mounting grommets onto the two mounting studs installed on the K&N® airbox.



17. Set the K&N® airbox into the vehicle so that the mounting studs slide into the mounting holes, and then secure with the hardware provided.



18. Install the provided silicone hose (08418) onto the filter adapter and secure with the provided hose clamp.



19. Install the provided silicone hose (08698) onto the throttle body and secure with the provided hose clamp.



20. Install the crankcase vent fitting into the K&N® intake tube as shown.

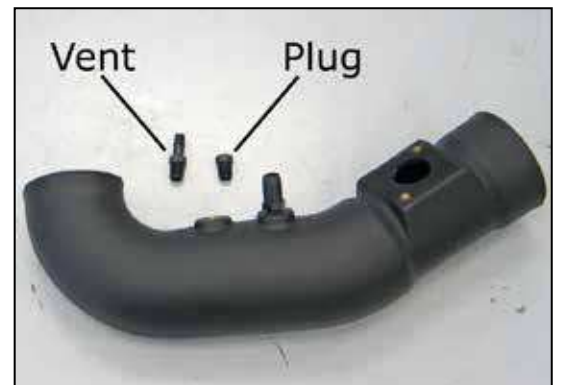

21. On vehicles that have an EVAP vent line attached to the intake tube, install the 3/8" vent fitting into the K&N® intake tube. On vehicles that do not have the EVAP vent line attached to the intake tube, install the NPT plug into the intake tube.  
**NOTE: Plastic NPT fittings are easy to cross thread. Install the vent fitting "hand" tight, then turn it two complete turns with a wrench.**



22. Remove the two bolts securing the mass air sensor into the factory intake tube and then remove the mass air sensor from the intake tube.



23. Install the provided mass air adapter gasket as shown.





24. Install the mass air sensor into the K&N® adapter and secure with the provided hardware.



25. Install the mass air sensor assembly into intake tube and secure with the provided hardware.

**NOTE: Be sure the open end of the sensor is facing the filter end of the tube.**



26. Install the K&N® intake tube into the silicone hose at the airbox and then into the silicone hose at the throttle body; secure with the provided hose clamps.



27. Install the crankcase vent hose to the fitting on the K&N® intake tube and onto the valve cover. Vehicles equipped with an EVAP vent line, connect it to the fitting installed in the K&N® intake tube.



28. Reconnect the mass air sensor electrical connection.



29. Install the K&N® air filter onto the filter adapter and secure with the provided hose clamp.

**NOTE: Drycharger® air filter wrap; part # RF-1036DK is available to purchase separately. To learn more about Drycharger® filter wraps or look up color availability please visit <http://www.knfilters.com>®.**



30. Install the K&N® airbox lid and secure with the provided hardware.



31. Reinstall the engine cover.



32. Reconnect the vehicle's negative battery cable. Double check to make sure everything is tight and properly positioned before starting the vehicle.

33. It will be necessary for all K&N® high flow intake systems to be checked periodically for realignment, clearance and tightening of all connections. Failure to follow the above instructions or proper maintenance may void warranty.

#### ROAD TESTING:

1. Start the engine with the transmission in neutral or park, and the parking brake engaged. Listen for air leaks or odd noises. For air leaks secure hoses and connections. For odd noises, find cause and repair before proceeding. This kit will function identically to the factory system except for being louder and much more responsive.

2. Test drive the vehicle. Listen for odd noises or rattles and fix as necessary.

3. If road test is fine, you can now enjoy the added power and performance from your kit.

4. K&N Engineering, Inc., requires cleaning the intake system's air filter element every 100,000 miles. When used in dusty or off-road environments, our filters will require cleaning more often. We recommend that you visually inspect your filter once every 25,000 miles to determine if the screen is still visible. When the screen is no longer visible some place on the filter element, it is time to clean it. To clean and re-oil, purchase our filter Recharger® service kit, part number 99-5050 or 99-5000 and follow the easy instructions.

**LEGAL IN CALIFORNIA ONLY FOR RACING VEHICLES WHICH MAY NEVER BE USED, REGISTERED OR LICENSED FOR USE UPON A HIGHWAY.**

See [knfilters.com](http://knfilters.com) for CARB status on each part for a specific vehicle