



INTAKE SYSTEMS FOR VEHICLES LISTED ARE 50 STATE LEGAL. SEE KNFILTERS.COM FOR CARB STATUS ON EACH PART FOR A SPECIFIC VEHICLE.

INSTALLATION INSTRUCTIONS

57-2529-1
FORD / MAZDA
2001-03 Ranger
2001-03 B4000
2001 Explorer
2001-03 Explorer Sport
***2001-04 Explorer Sport Trac**
V6-4.0L SOHC

*Models with production date from 7/24/00
 NOTE: This kit was not designed to fit vehicles with a body lif

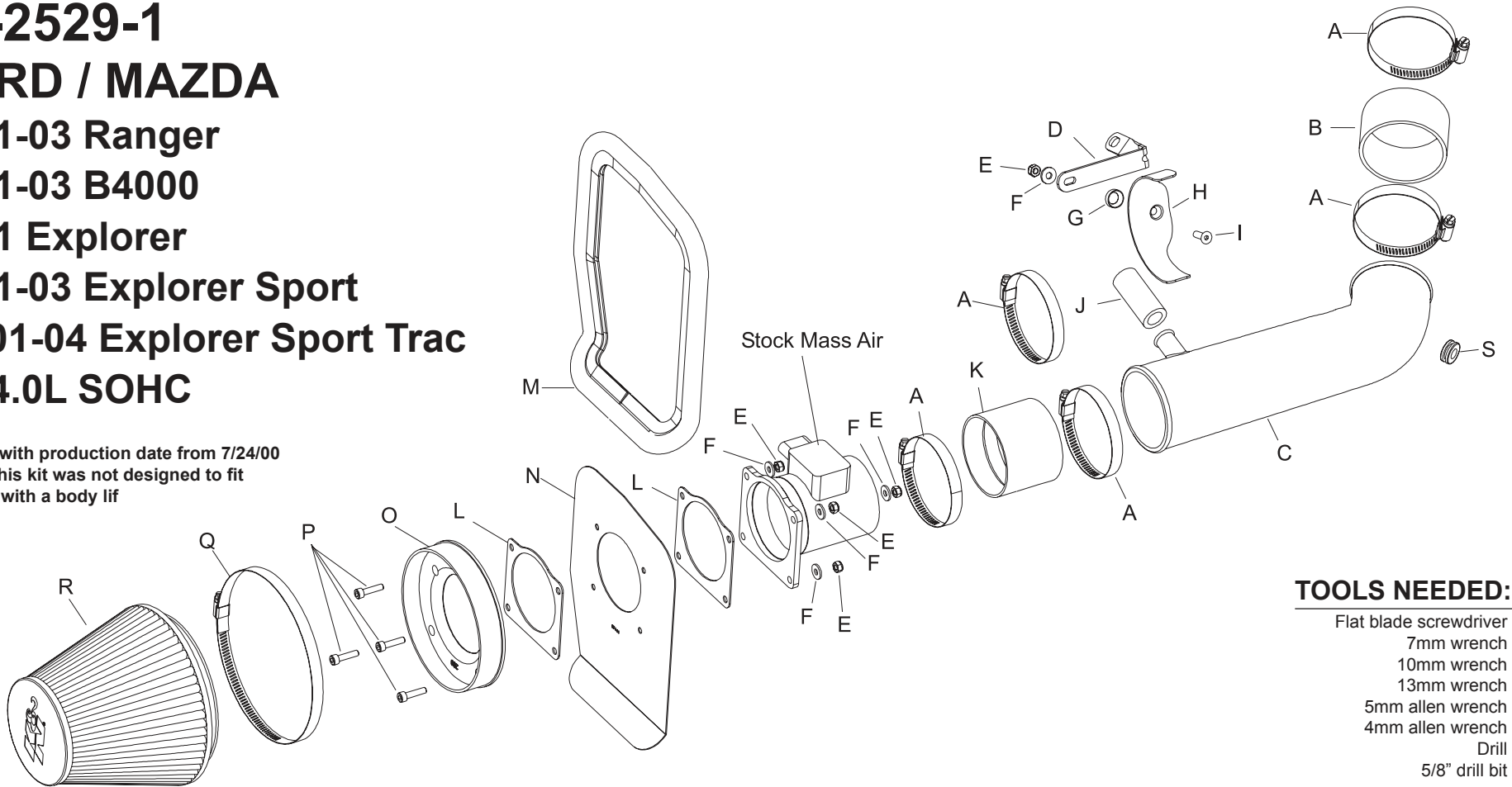

- TOOLS NEEDED:**
- Flat blade screwdriver
 - 7mm wrench
 - 10mm wrench
 - 13mm wrench
 - 5mm allen wrench
 - 4mm allen wrench
 - Drill
 - 5/8" drill bit

PARTS LIST:

Description	Qty.	Part #	Description	Qty.	Part #	Description	Qty.	Part #
A Hose clamp #52	5	08610	G Washer, conical	1	08180	M Edge trim, 33"L	1	102498
B Silicone hose, throttle body	1	08630	H Saddle bracket	1	078855	N Heat shield	1	07444
C K&N intake tube	1	087020	I 6mm flat head allen bolt	1	08376	O Mass air adapter #200	1	08831
D Bracket	1	070018	J Rubber hose, 5/8" id x 2-1/4" l	1	08692	P 6mm allen bolt	4	07859
E 6mm nylock nut	5	07553	K Silicone hose, mass air	1	08690	Q Hose clamp, #104	1	08697
F Flat washer	5	08275	L Mass air gasket	2	09330	R K&N Air filter	1	RF-1048
						S Grommet	1	08092

NOTE: FAILURE TO FOLLOW INSTALLATION INSTRUCTIONS AND NOT USING THE PROVIDED HARDWARE MAY DAMAGE THE INTAKE TUBE, THROTTLE BODY AND ENGINE.

TO START:

1. Turn off the ignition and disconnect the negative battery cable.
NOTE: Disconnecting the negative battery cable erases pre-programmed electronic memories. Write down all memory settings before disconnecting the negative battery cable. Some radios will require an anti-theft code to be entered after the battery is reconnected. The anti-theft code is typically supplied with your owner's manual. In the event your vehicles' anti-theft code cannot be recovered, contact an authorized dealership to obtain your vehicles anti-theft code.



2. Disconnect the mass air sensor electrical connection.

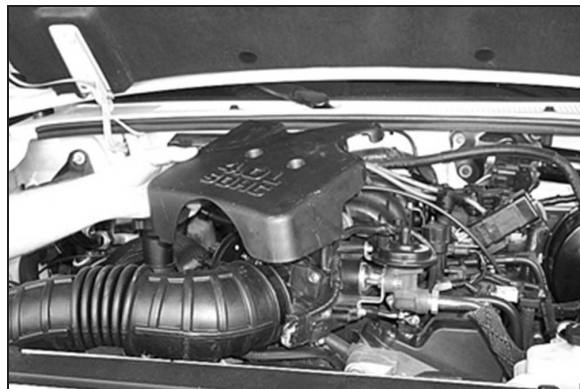

3. Loosen and remove the three bolts that secure the throttle body cover, then remove the cover as shown.



4. Remove the crankcase vent hose from the stock intake tube as shown.



5. On vehicles that come with a second vent line, remove hose from intake tube then release the two clips that retain the hose to the engine cover.



6. Loosen the hose clamp at the throttle body and at the mass air sensor, then remove the stock air intake tube as shown.

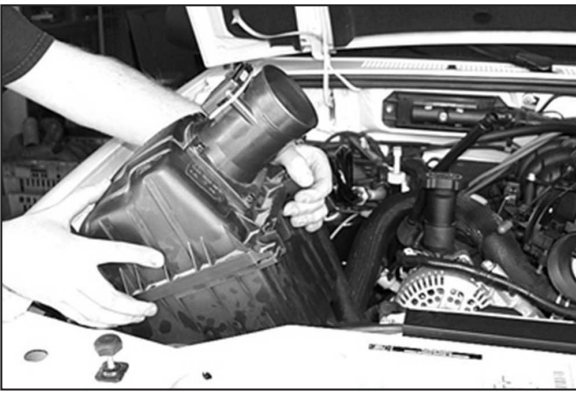

7. Using a screwdriver, pry up the bottom of the air cleaner to release the air cleaner from the stock grommets, then remove the air cleaner assembly as shown.

Note: K&N recommends that customers do not discard factory air intake.



8. Loosen and remove the four bolts that secure the mass air sensor, then remove the mass air sensor as shown.

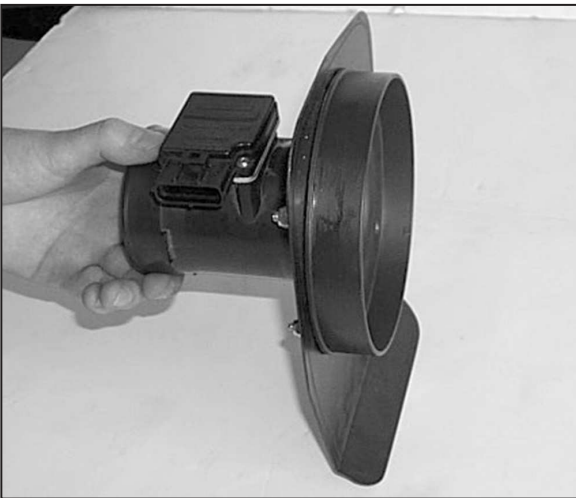

9. Assemble the mass air adapter, gaskets, heat shield and mass air sensor as shown.



10. Apply the trim seal to the heat shield assembly as shown.

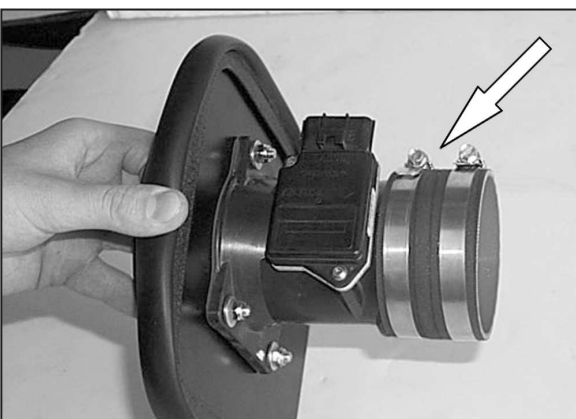

11. Assemble the silicone hose and the hose clamps onto the heat shield assembly as shown.

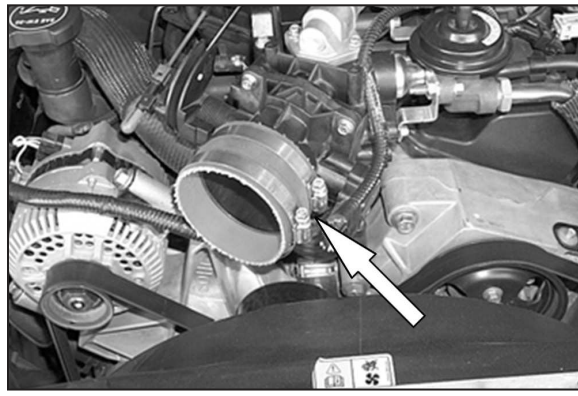

12. Install the silicone hose (08630) and the hose clamps onto the throttle body as shown.



13. Using the provided hardware, assemble the saddle bracket assembly as shown.

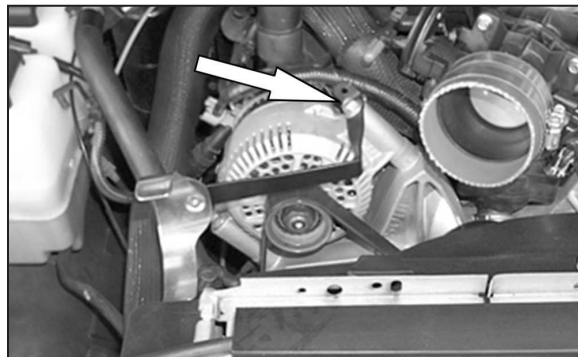

14. Remove the upper alternator bolt and harness clip, then secure the saddle bracket assembly to the alternator as shown.

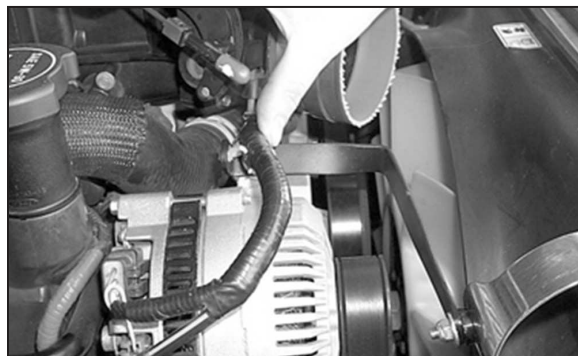

15. Push the wire harness push clip into the hole on the saddle bracket as shown.

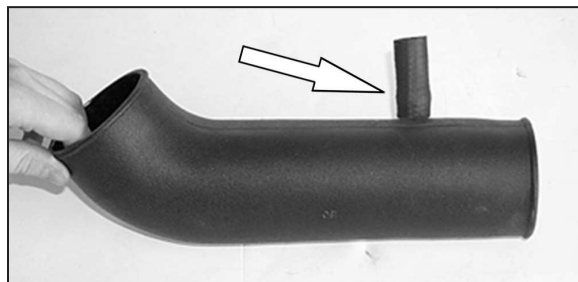

16. Install the rubber hose onto the K&N intake tube as shown.

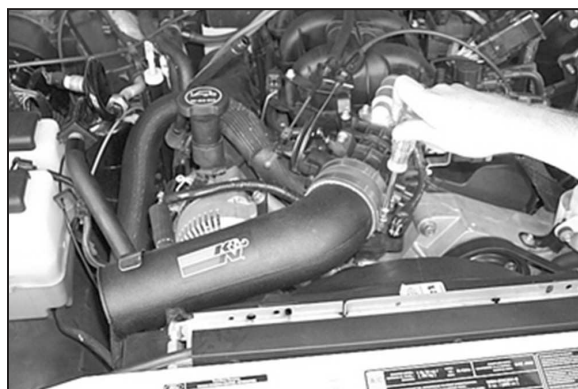

17. Install the K&N intake tube onto the throttle body and line it up with the saddle bracket assembly as shown.



18. On vehicles that come equipped with a second vent line, line up the vent hose on the intake tube and make a mark on the intake tube for drilling.



18a. After marking the intake tube, remove the tube from the vehicle and drill a 5/8" hole into the intake tube then install the provided grommet as shown.



19. Re-install the K&N intake tube onto the throttle body then secure the intake tube to the saddle bracket assembly with the provided hose clamp.



20. Re-connect the crankcase vent hose to the K&N intake tube as shown.



21. Vehicles that come equipped with a second vent line, reconnect as shown



22. Assemble the K&N Air filter onto the heat shield assembly as shown.
NOTE: Drycharger air filter wrap; part # RF-1048DK is available to purchase separately. To learn more about Drycharger filter wraps or look up color availability please visit <http://www.knfilters.com>.

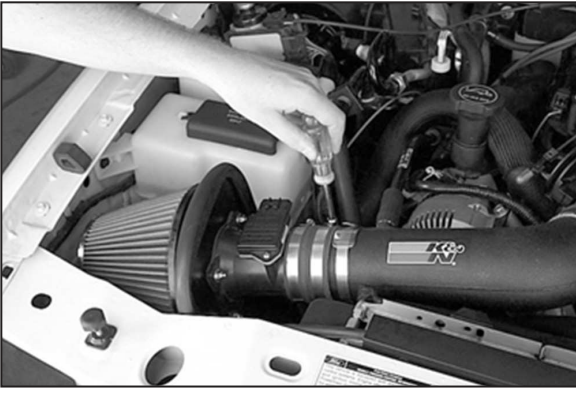

23. Install the heat shield assembly onto the K&N® intake tube and tighten the hose clamp as shown.



24. Re-connect the mass air sensor electrical connection as shown.



25. Re-install the throttle body cover as shown.

26. Reconnect the vehicle's negative battery cable. Double check to make sure everything is tight and properly positioned before starting the vehicle.

27. The C.A.R.B. exemption sticker, (attached), must be visible under the hood so that an emissions inspector can see it when the vehicle is required to be tested for emissions. California requires testing every two years, other states may vary.

28. It will be necessary for all K&N® high flow intake systems to be checked periodically for realignment, clearance and tightening of all connections. Failure to follow the above instructions or proper maintenance may void warranty.

ROAD TESTING:

1. Start the engine with the transmission in neutral or park, and the parking brake engaged. Listen for air leaks or odd noises. For air leaks secure hoses and connections. For odd noises, find cause and repair before proceeding. This kit will function identically to the factory system except for being louder and much more responsive.

2. Test drive the vehicle. Listen for odd noises or rattles and fix as necessary.

3. If road test is fine, you can now enjoy the added power and performance from your kit.

4. K&N Engineering, Inc., requires cleaning the intake system's air filter element every 100,000 miles. When used in dusty or off-road environments, our filters will require cleaning more often. We recommend that you visually inspect your filter once every 25,000 miles to determine if the screen is still visible. When the screen is no longer visible some place on the filter element, it is time to clean it. To clean and re-oil, purchase our filter Recharger® service kit, part number 99-5050 or 99-5000 and follow the easy instructions.

INTAKE SYSTEMS FOR VEHICLES LISTED ARE 50 STATE LEGAL. SEE KNFILTERS.COM FOR CARB STATUS ON EACH PART FOR A SPECIFIC VEHICLE.