



INTAKE SYSTEMS FOR VEHICLES LISTED ARE 50 STATE LEGAL. SEE KNFILTERS.COM FOR CARB STATUS ON EACH PART FOR A SPECIFIC VEHICLE.

# INSTALLATION INSTRUCTIONS

**57-1516**  
**DODGE**  
**2000-04 Dakota**  
**2000-03 Durango**  
**V8-4.7L**

NOTE: This kit was not designed to fit vehicles with a body lift

**TOOLS NEEDED:**

- Flat Blade Screwdriver
- 10mm Socket
- 13mm Socket
- Long Extension
- Ratchet
- 7/16" Open End Wrench
- 7/16" Socket
- Drill
- 3/4" Drill Bit

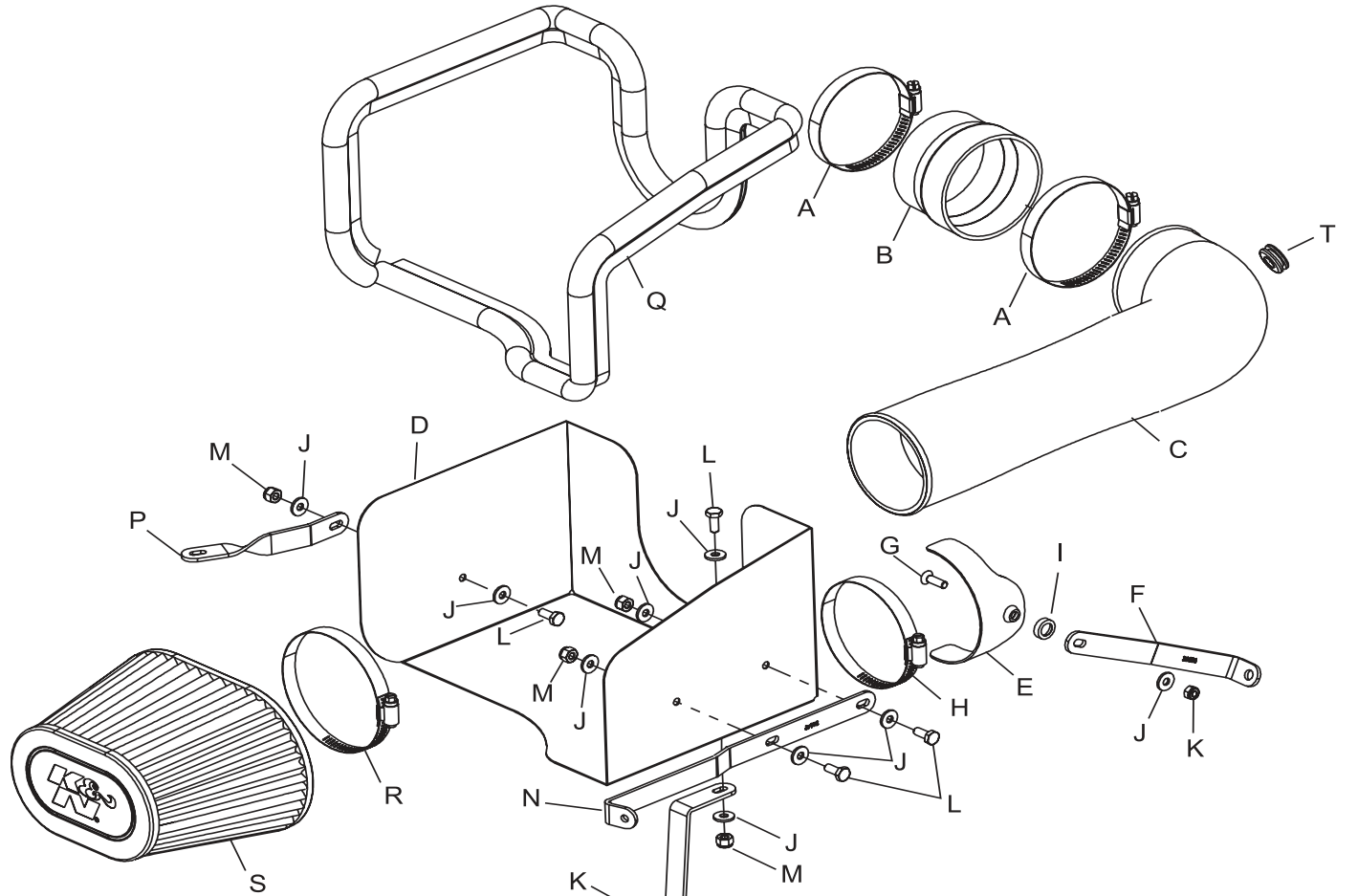

**PARTS LIST:**

| Description       | Qty. | Part # | Description                   | Qty. | Part # | Description       | Qty. | Part #  |
|-------------------|------|--------|-------------------------------|------|--------|-------------------|------|---------|
| A Hose Clamp #52  | 2    | 08610  | H Hose Clamp #48              | 1    | 08601  | O "Z" Bracket     | 1    | 26543   |
| B Silicone Hose   | 1    | 08051  | I Washer, Conical, Nylon Blk. | 1    | 08180  | P Twist Bracket   | 1    | 26544   |
| C Intake Tube     | 1    | 087047 | J Washer, 1/4 x 5/8" OD       | 10   | 08275  | Q Trim Seal, 57"L | 1    | 102470  |
| D Heat Shield     | 1    | 07462  | K Nut, 6mm Nylock             | 2    | 07553  | R Hose Clamp #60  | 1    | 08624   |
| E Saddle Bracket  | 1    | 078855 | L Bolt, 1/4-20 x 5/8 Hexhead  | 4    | 08386  | S Air Filter      | 1    | RC-5040 |
| F Bracket         | 1    | 26526  | M Nut, 1/4 x 20 Nylock        | 4    | 07517  | T Grommet         | 1    | 08064   |
| G Bolt, 6mm F/H/A | 1    | 08376  | N Large "L" Bracket           | 1    | 26542  |                   |      |         |

**NOTE: FAILURE TO FOLLOW INSTALLATION INSTRUCTIONS AND NOT USING THE PROVIDED HARDWARE MAY DAMAGE THE INTAKE TUBE, THROTTLE BODY AND ENGINE.**

**TO START:**

1. Turn off the ignition and disconnect the negative battery cable.

**NOTE: Disconnecting the negative battery cable erases pre-programmed electronic memories. Write down all memory settings before disconnecting the negative battery cable. Some radios will require an anti-theft code to be entered after the battery is reconnected. The anti-theft code is typically supplied with your owner's manual. In the event your vehicles' anti-theft code cannot be recovered, contact an authorized dealership to obtain your vehicles anti-theft code.**

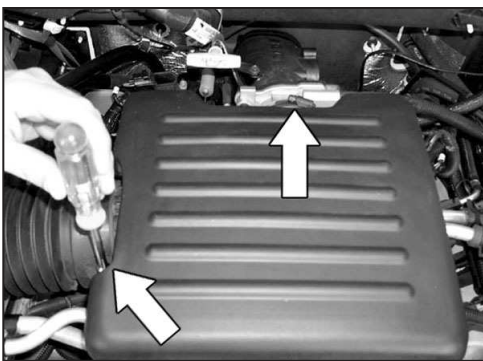

2. Loosen the hose clamp at the throttle body and air intake tube as shown.

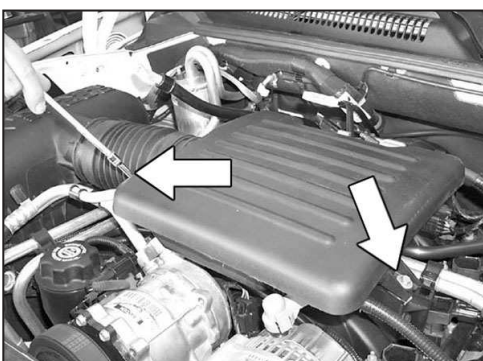

3. Loosen and remove the two bolts that retain the air resonator to the intake manifold as shown.

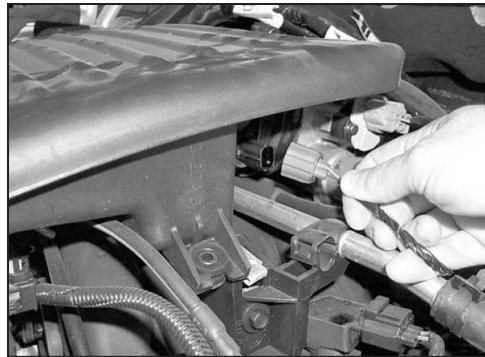

3a. On vehicles that come equipped with an air temperature sensor, disconnect the electrical connection as shown.

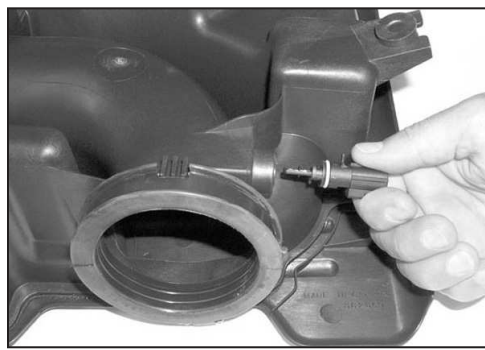

3b. To remove temperature sensor from resonator, turn sensor 1/8 of a turn counter clockwise and remove the sensor as shown.



4. Remove the air resonator from vehicle as shown.



5. Remove the vent hose from the air box as shown.

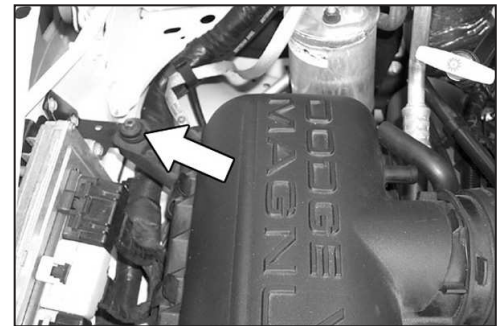

6. Loosen and remove the nut that retains the air box to the vehicle.



7. Pull firmly upwards on the stock air box to remove from the vehicle as shown.

**NOTE: K&N Engineering, Inc., recommends that customers do not discard factory air intake.**

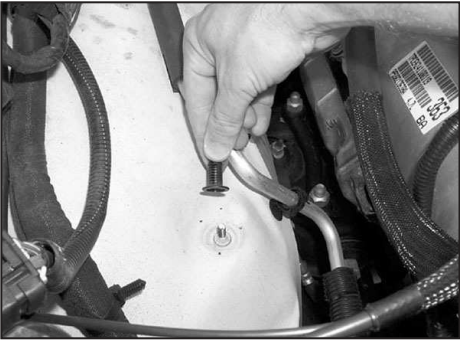

8. Unscrew the plastic air box retaining stud from the vehicle as shown.



9. Apply the provided trim seal to the heat shield as shown. Trim if necessary.



10. Mount the provided "Z" bracket onto the inner fender well as shown. Do not tighten completely.



11. Install the provided large "L" bracket onto the heat shield as shown. Do not tighten completely.



12. Install the provided twist bracket onto the heat shield as shown. Do not tighten completely.

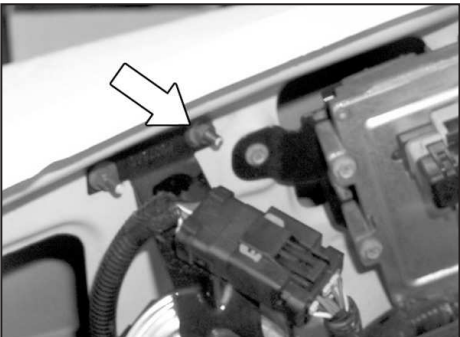

13. Remove the nut that retains the cruise control bracket to the inner fender.



14. Install the heat shield into the vehicle as shown.

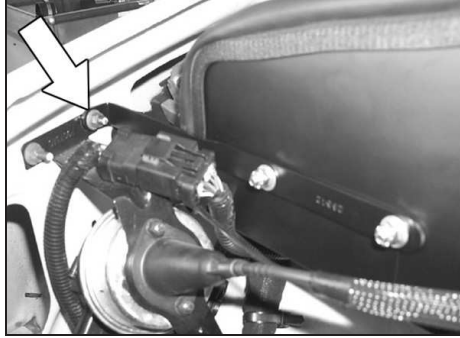

15. Using the nut that was removed in step 13, secure the bracket to the inner fender well.

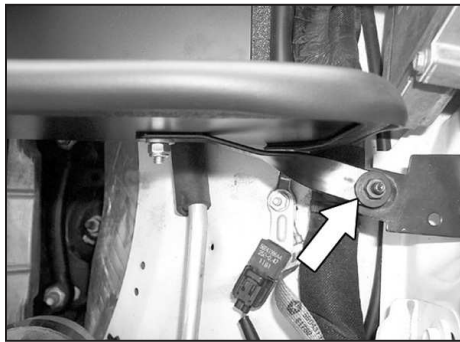

16. Using the nut that was removed in step 6, secure the bracket to the air box mounting stud as shown. Do not completely tighten at this time.

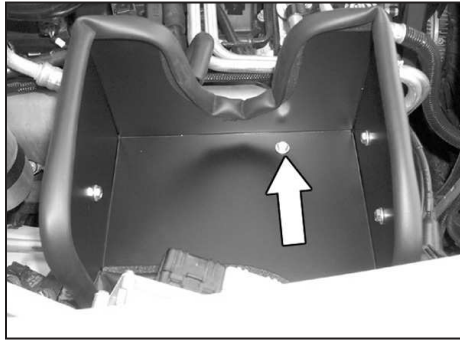

17. Attach the heat shield onto the lower "Z" bracket with the provided hardware.



18. Assemble the saddle bracket to the "L" bracket as shown.

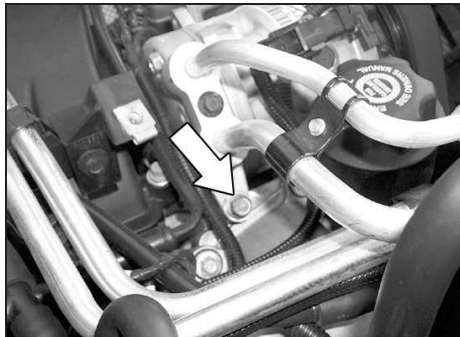

19. Remove the bolt from the A/C compressor as shown.

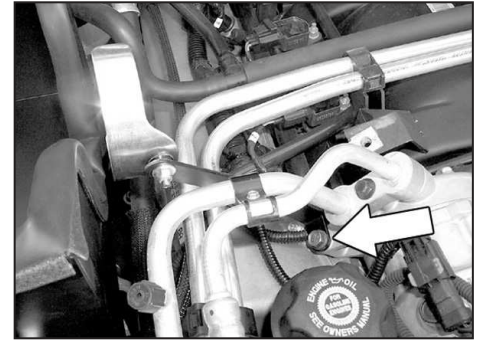

20. Install the saddle bracket assembly onto the A/C compressor with the bolt that was removed in step 19.



21. Install the silicone hose onto the K&N® intake tube as shown

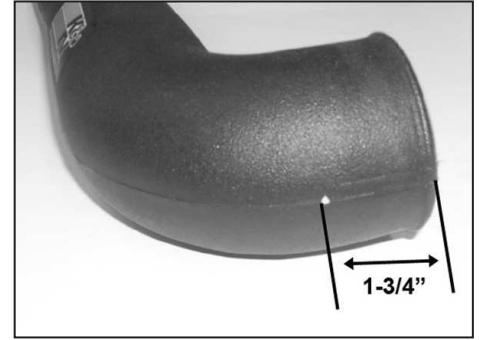

21a. On models that come equipped with an external temperature sensor, mark the intake tube 1-3/4" from the end of the tube, then drill a 3/4" hole into the intake tube.

**NOTE: Clean out all plastic shavings from the inside of the intake tube.**



21b. Install the provided grommet into the intake tube as shown



21c. Remove the factory O-ring from the temperature sensor, then install the sensor into the intake tube as shown.



22. Install the intake tube onto the throttle body as shown.

**NOTE: Make sure the hose clamp screws are located on the driver's side of the vehicle as shown.**

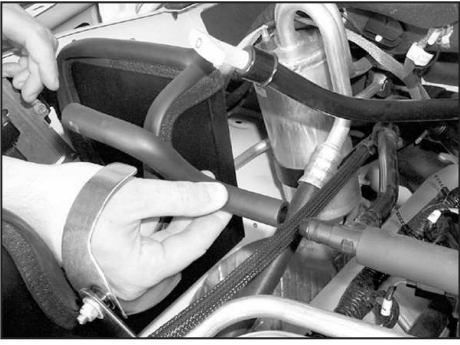

23. Remove the vent hose from the vehicle as shown.

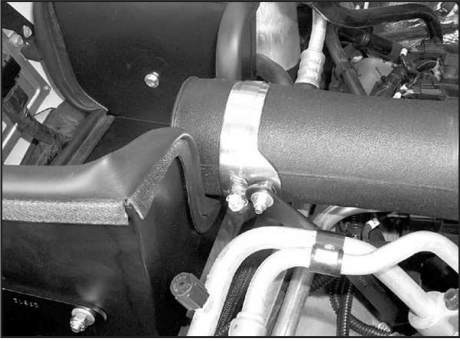

24. Secure the saddle bracket onto the K&N® intake tube with the provided hose clamp as shown.



25. Cut the vent hose that was removed in step 23 as shown.

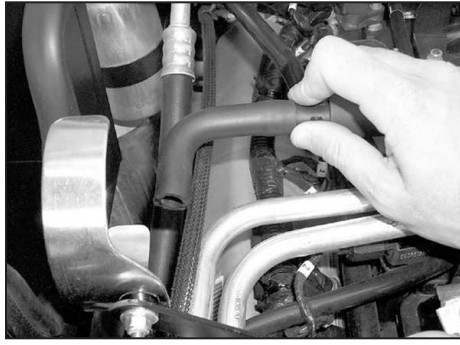

26. Re-install the vent hose onto the vent line as shown.

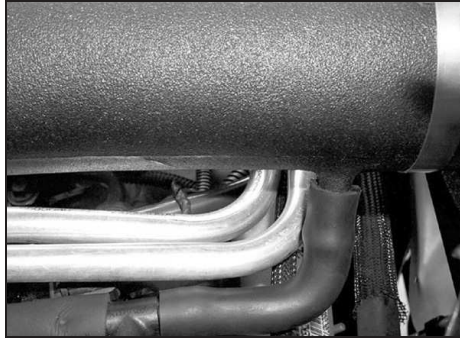

27. Connect the vent hose onto the K&N® intake tube as shown.



28. On vehicle's that come equipped with an air temperature sensor, re-connect the electrical connection as shown.



29. Reconnect the vehicle's negative battery cable. Double check to make sure everything is tight and properly positioned before starting the vehicle.

30. The C.A.R.B. exemption sticker, (attached), must be visible under the hood so that an emissions inspector can see it when the vehicle is required to be tested for emissions. California requires testing every two years, other states may vary.

31. It will be necessary for all K&N® high flow intake systems to be checked periodically for realignment, clearance and tightening of all connections. Failure to follow the above instructions or proper maintenance may void warranty.

#### ROAD TESTING:

1. Start the engine with the transmission in neutral or park, and the parking brake engaged. Listen for air leaks or odd noises. For air leaks secure hoses and connections. For odd noises, find cause and repair before proceeding. This kit will function identically to the factory system except for being louder and much more responsive.

2. Test drive the vehicle. Listen for odd noises or rattles and fix as necessary.

3. If road test is fine, you can now enjoy the added power and performance from your kit.

4. K&N Engineering, Inc., requires cleaning the intake system's air filter element every 100,000 miles. When used in dusty or off-road environments, our filters will require cleaning more often. We recommend that you visually inspect your filter once every 25,000 miles to determine if the screen is still visible. When the screen is no longer visible some place on the filter element, it is time to clean it. To clean and re-oil, purchase our filter Recharger® service kit, part number 99-5050 or 99-5000 and follow the easy instructions.

**INTAKE SYSTEMS FOR VEHICLES LISTED ARE 50 STATE LEGAL. SEE KNFILTERS.COM FOR CARB STATUS ON EACH PART FOR A SPECIFIC VEHICLE.**